

61 Oslo og Akershus SSK 1

Oslo og Akershus SSK

Result: 15

Shooting 1 - Prone at lane 1 5 shots at 10.3s Result: 3 + 0

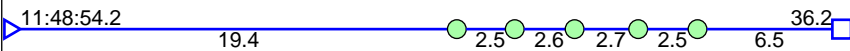
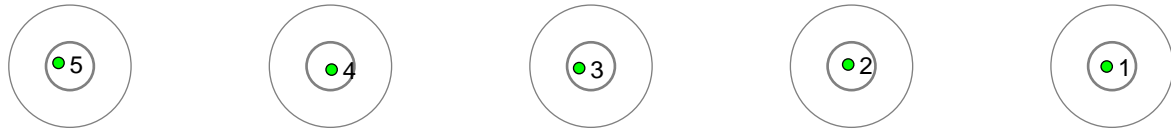

Shooting 2 - Standing at lane 1 8 shots at 37.7s Result: 4 + 3

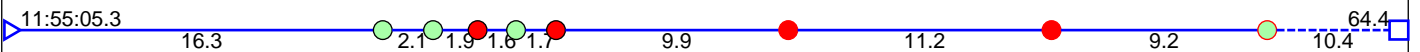
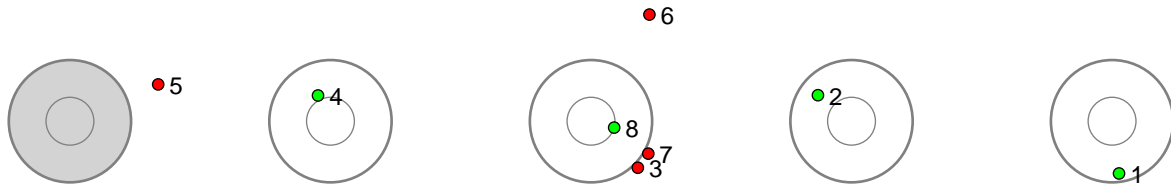

Shooting 3 - Prone at lane 2 8 shots at 37.4s Result: 5 + 3

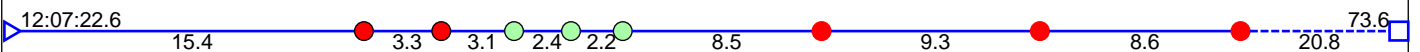
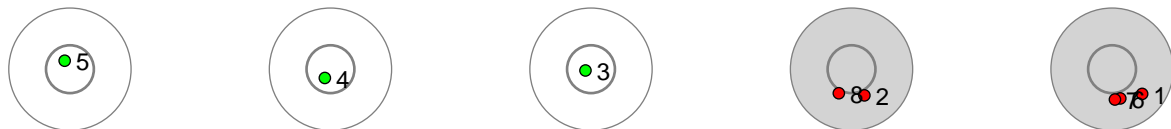

Shooting 4 - Standing at lane 4 6 shots at 17.7s Result: 3 + 1

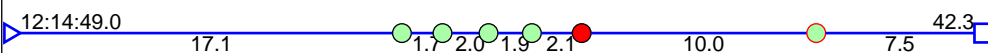
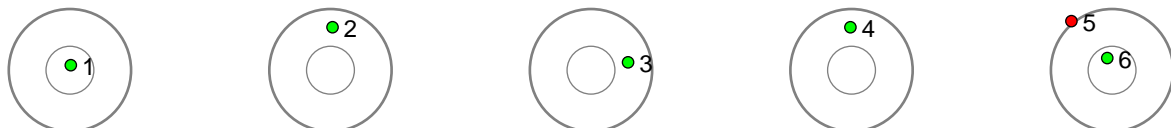

Shooting 5 - Prone at lane 2 6 shots at 23.5s Result: 0 + 1

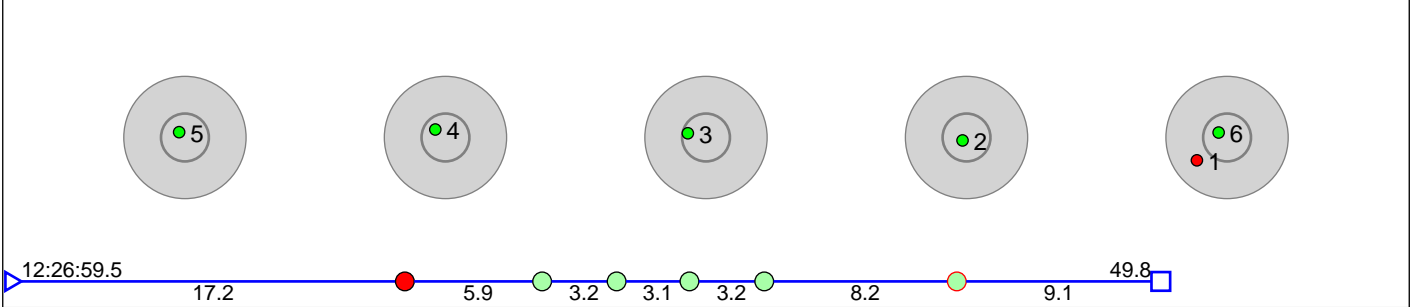

Shooting 6 - Standing at lane 2 5 shots at 14.3s Result: 0 + 0

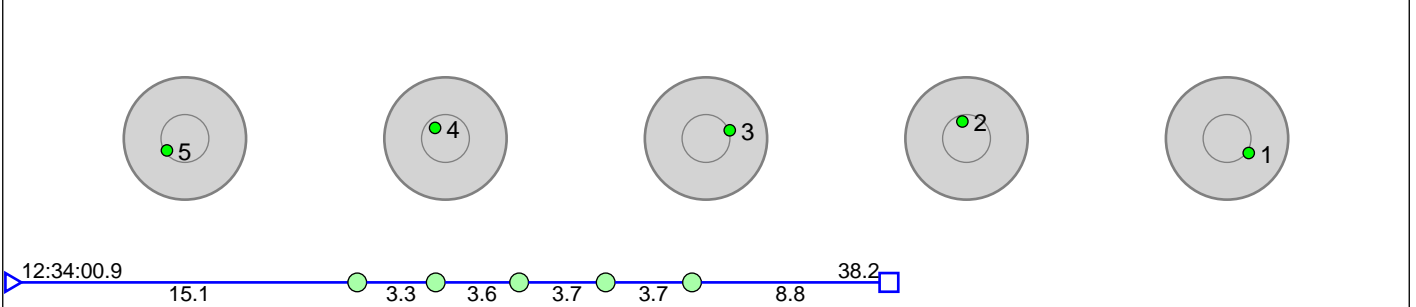

Shooting 7 - Prone at lane 2 5 shots at 12.7s Result: 0 + 0

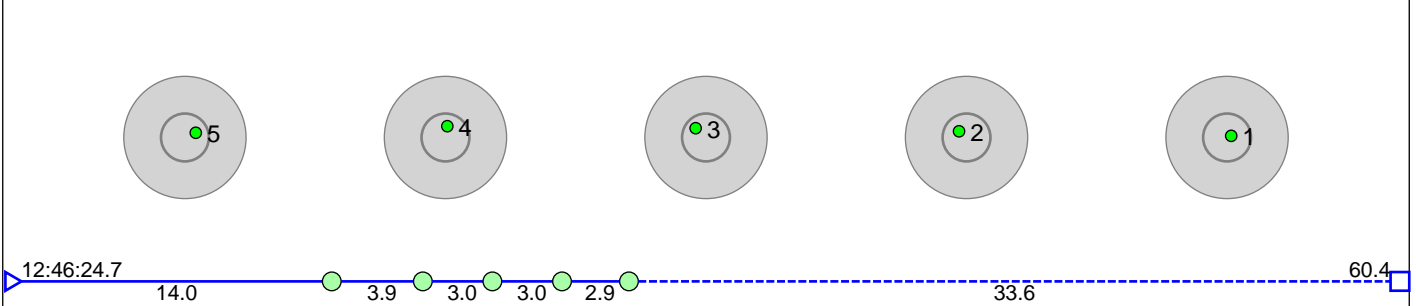

Shooting 8 - Standing at lane 2 5 shots at 7.8s Result: 0 + 0

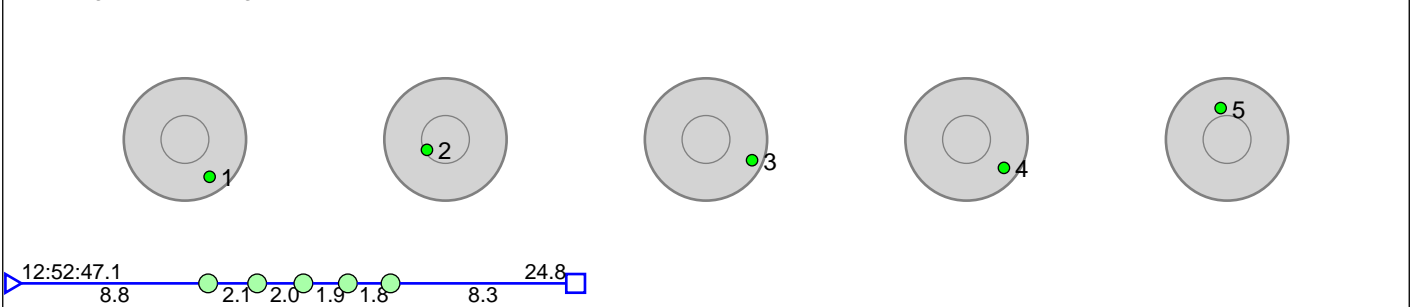

Disclaimer:

These results are unofficial since only the final output from the timing system can provide complete and correct competition results. The graphic plot of each series, presents the location of the shots on each of the five targets. Please observe that the accuracy of the plotting has some limitations due to image resolution and/or printer quality.

62 Troms SSK 1

Troms SSK

Result: 13

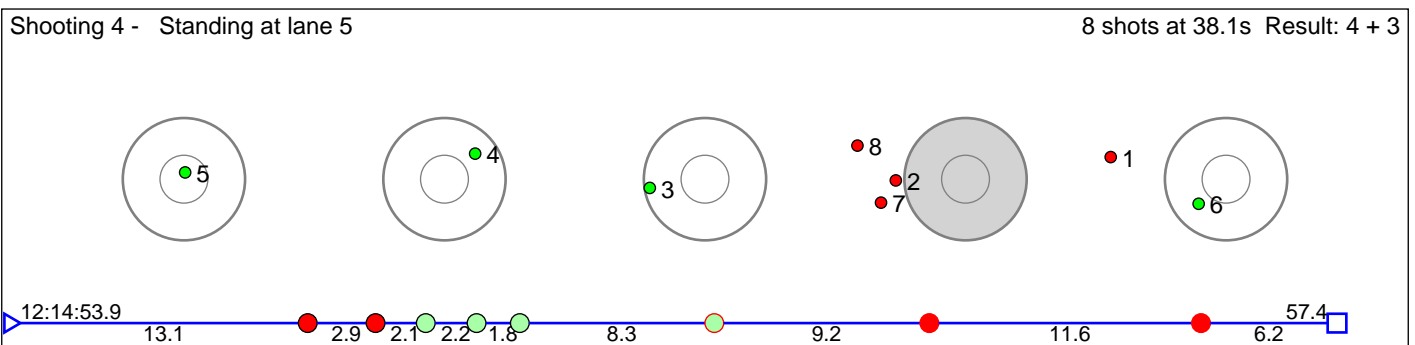
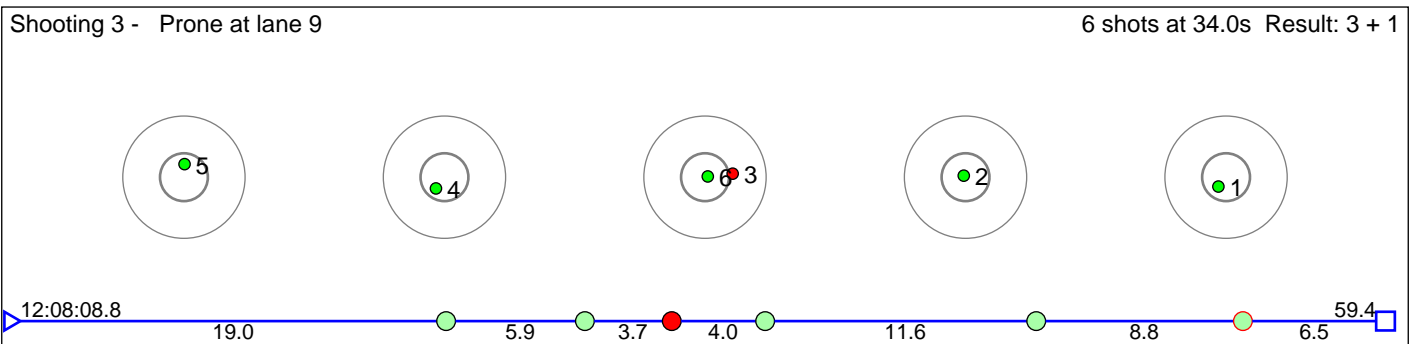
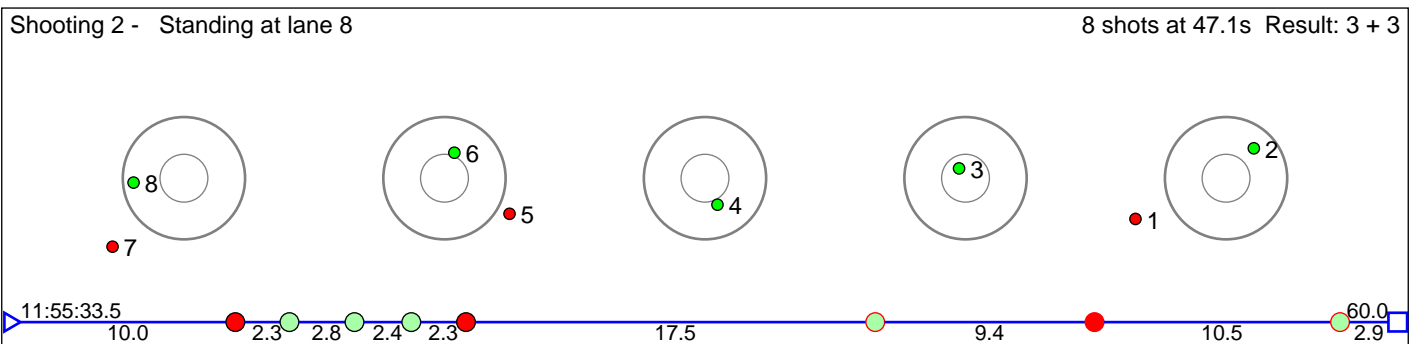
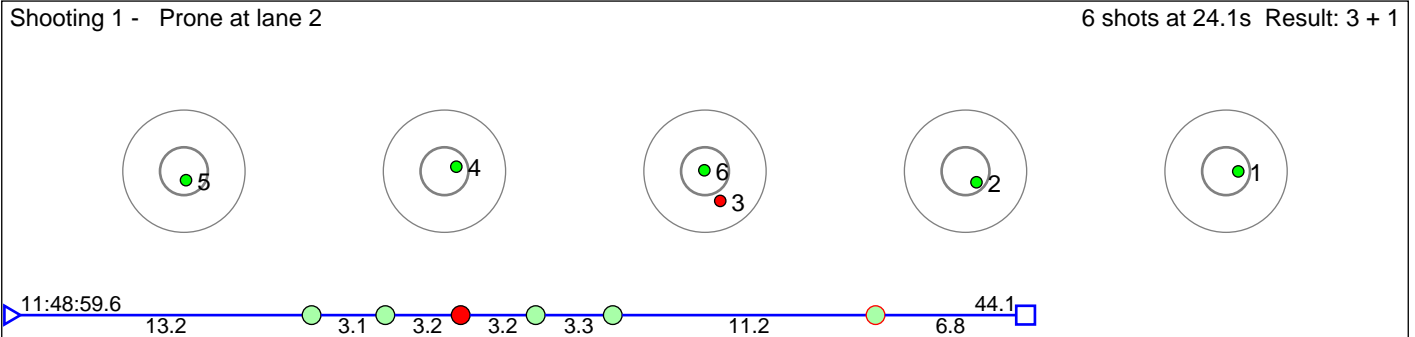

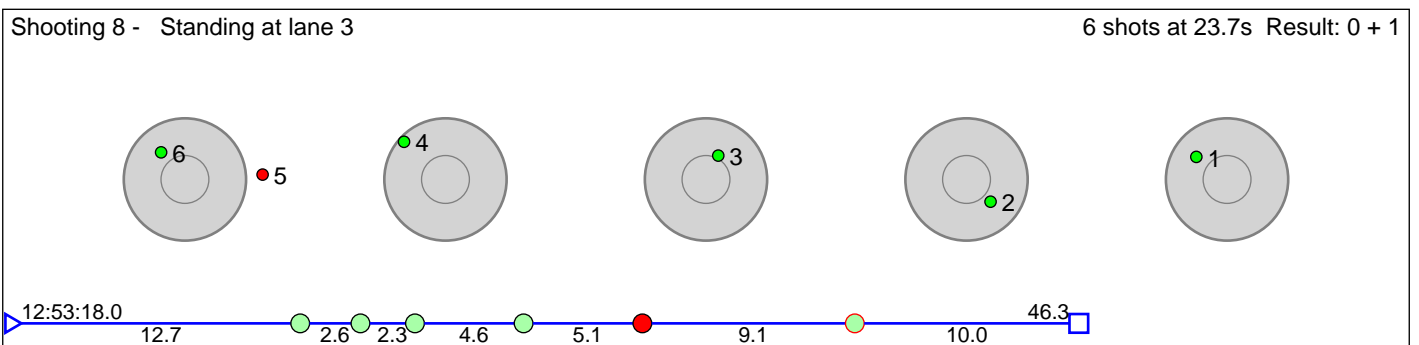
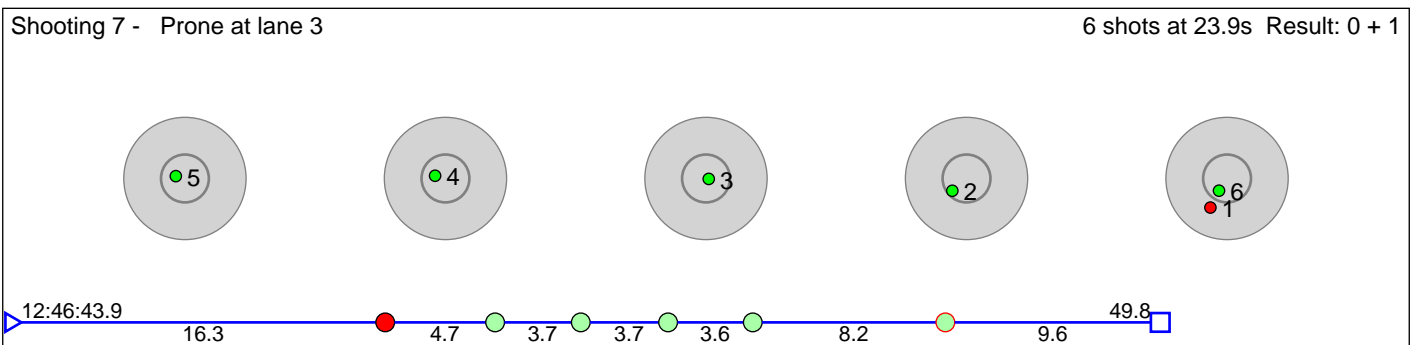
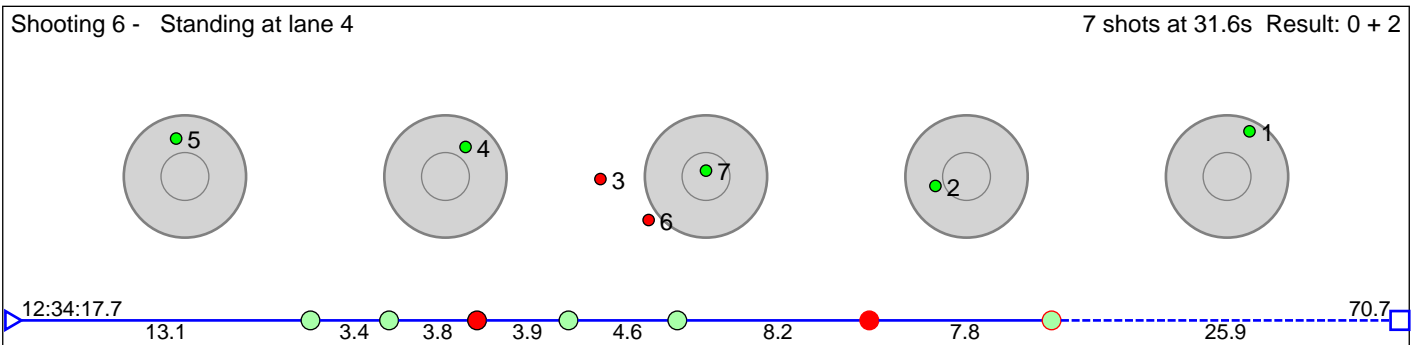
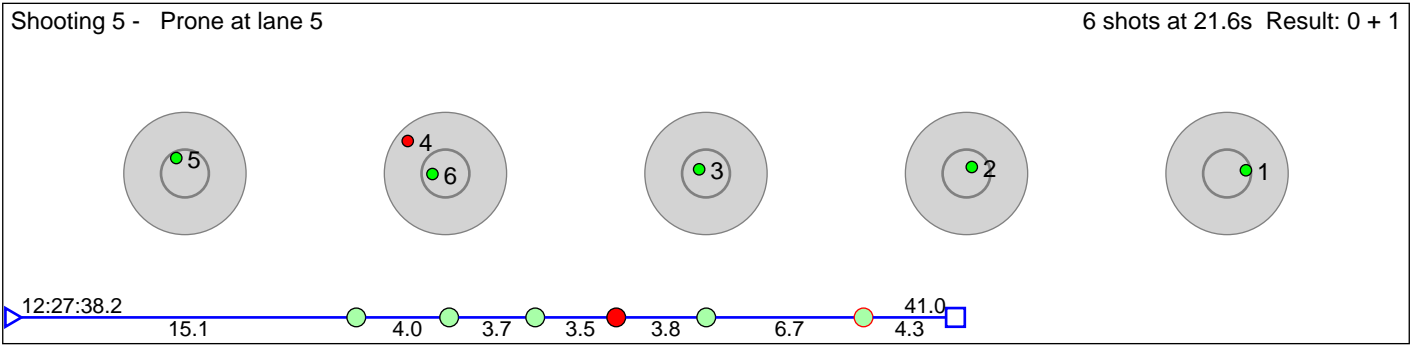

Disclaimer:

These results are unofficial since only the final output from the timing system can provide complete and correct competition results. The graphic plot of each series, presents the location of the shots on each of the five targets. Please observe that the accuracy of the plotting has some limitations due to image resolution and/or printer quality.

63 Oppland SSK 1

Oppland SSK

Result: 14

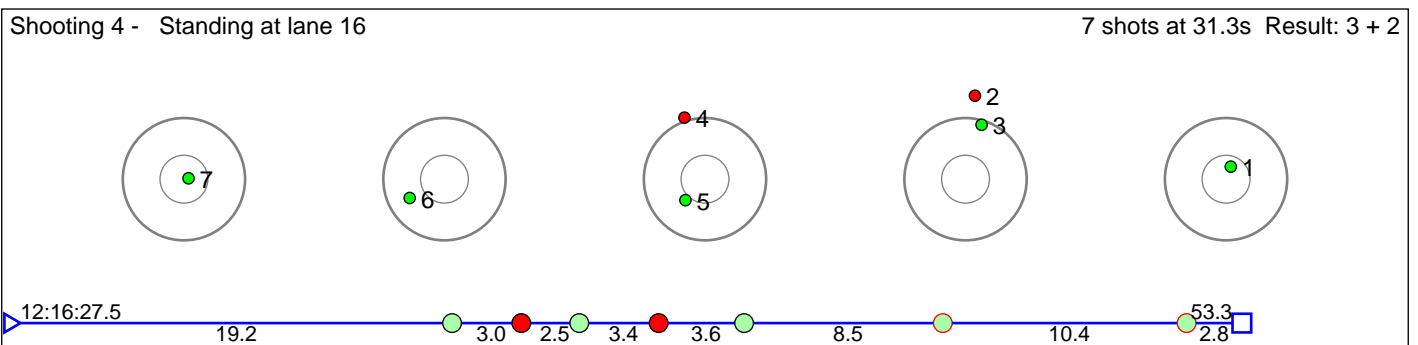
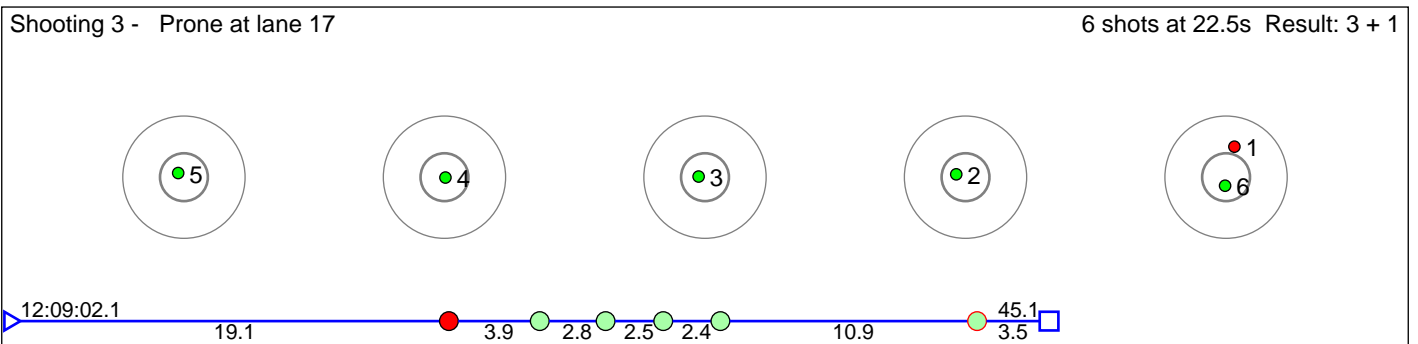
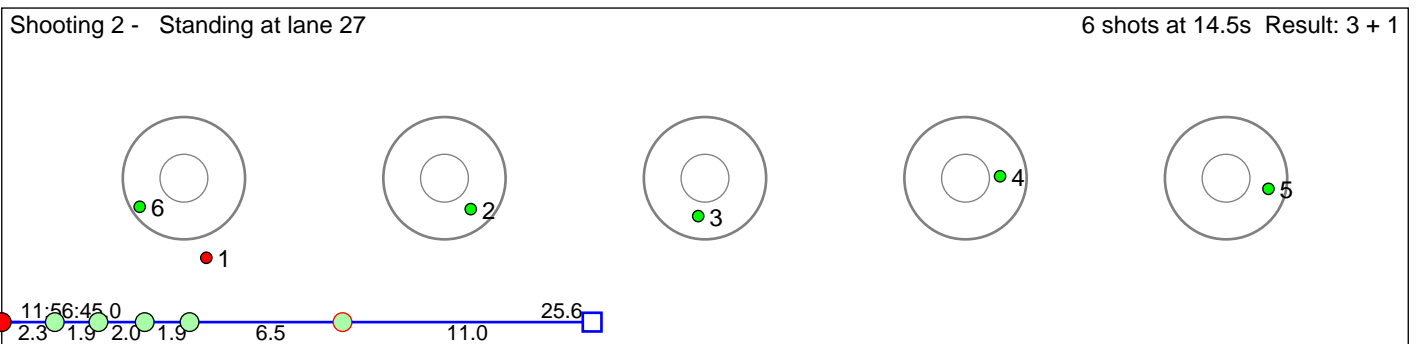
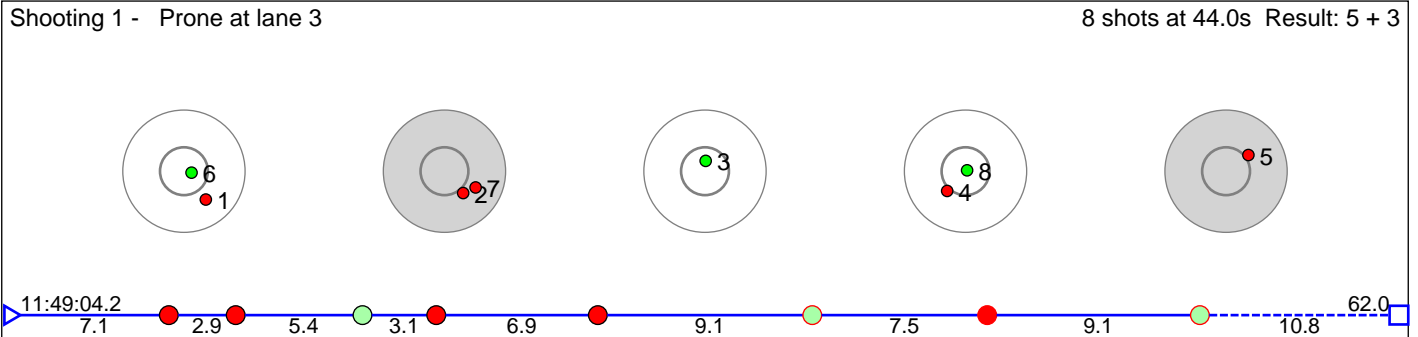

Shooting 5 - Prone at lane 20 5 shots at 12.9s Result: 0 + 0

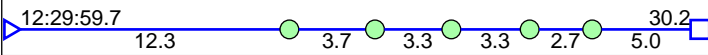
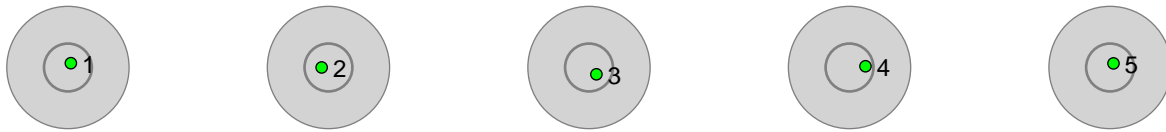

Shooting 6 - Standing at lane 16 7 shots at 32.4s Result: 0 + 2

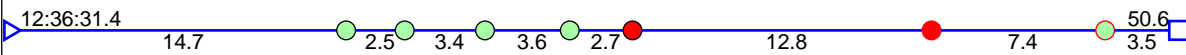
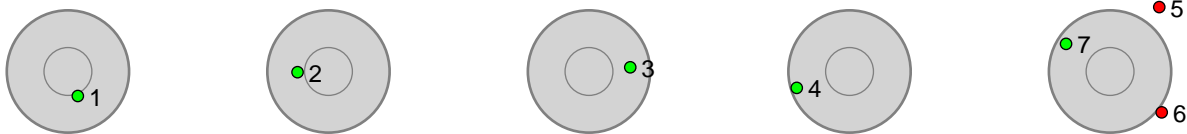

Shooting 7 - Prone at lane 11 6 shots at 18.8s Result: 0 + 1

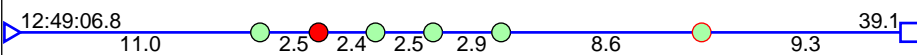
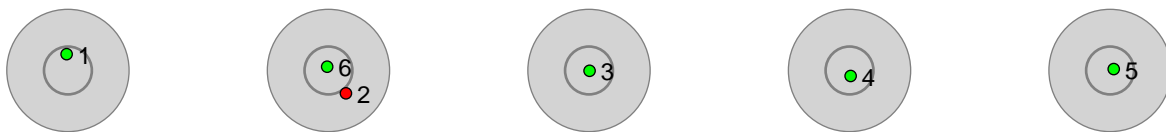

Shooting 8 - Standing at lane 8 6 shots at 20.0s Result: 0 + 1

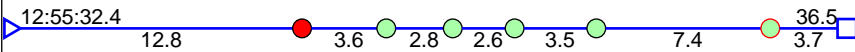
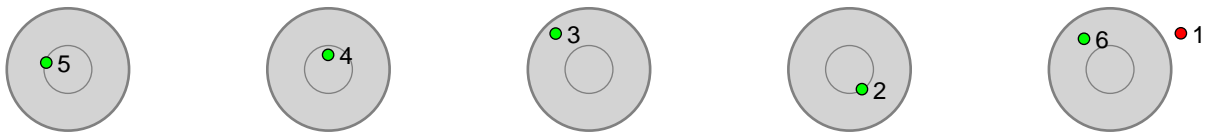

Disclaimer:

These results are unofficial since only the final output from the timing system can provide complete and correct competition results. The graphic plot of each series, presents the location of the shots on each of the five targets. Please observe that the accuracy of the plotting has some limitations due to image resolution and/or printer quality.

64 Agder og Rogaland SSK 1

Agder og Rogaland SSK

Result: 12

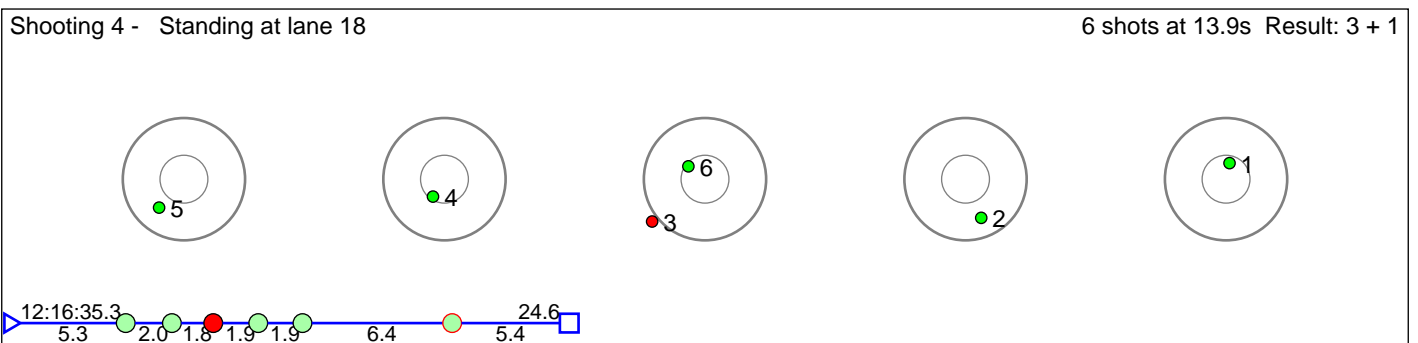
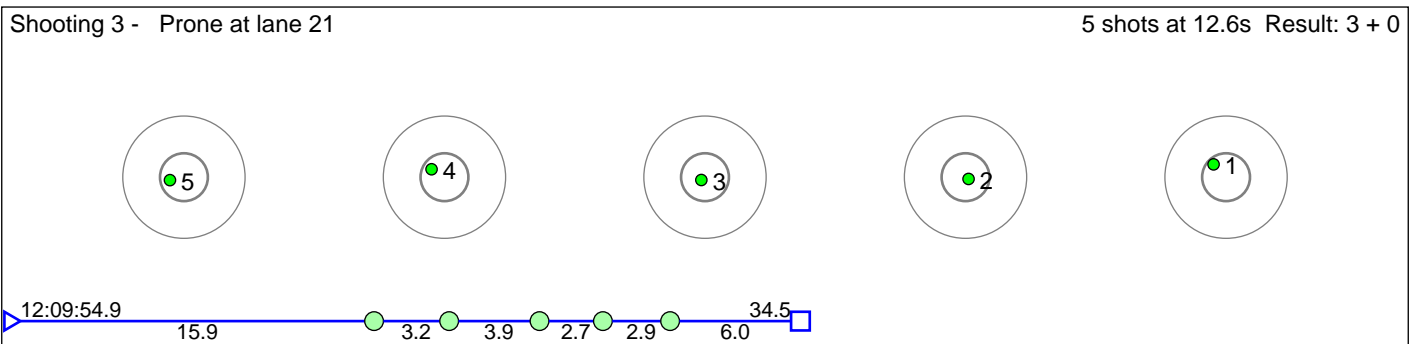
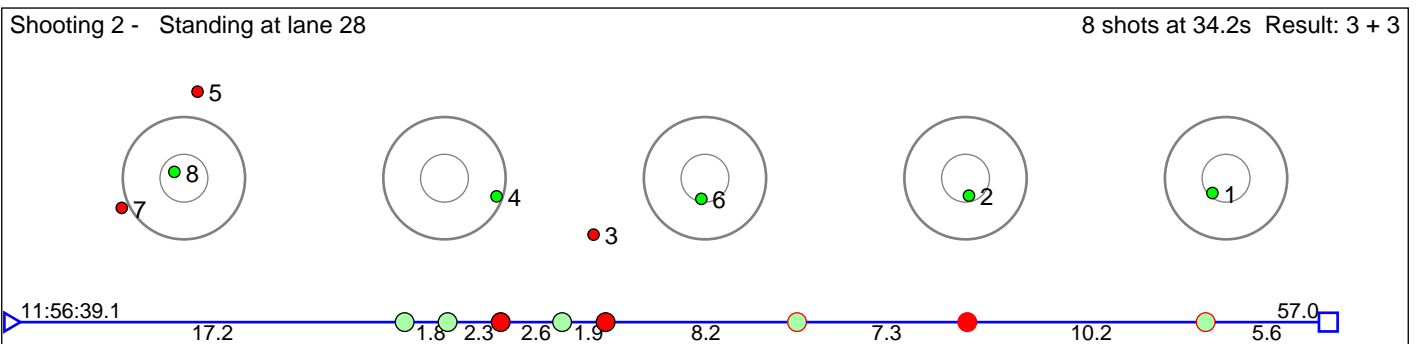
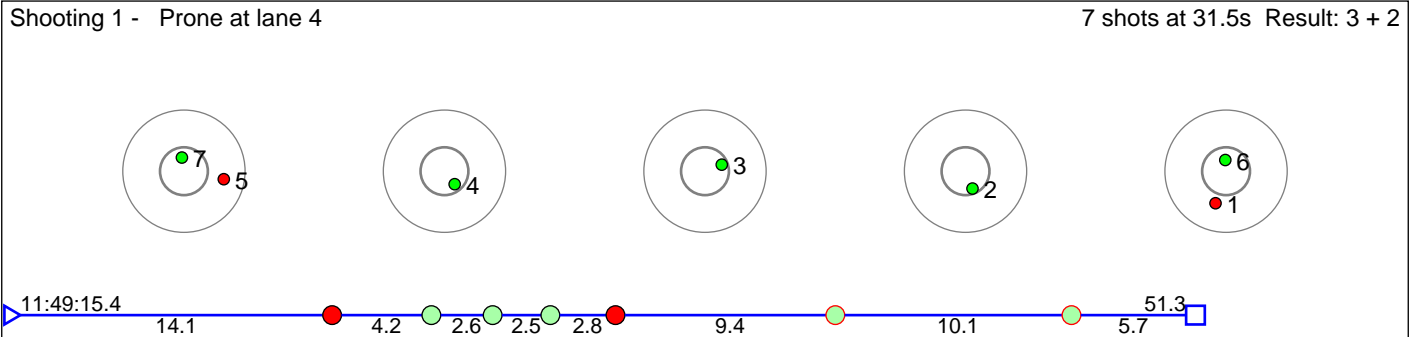

Shooting 5 - Prone at lane 10 7 shots at 35.5s Result: 0 + 2

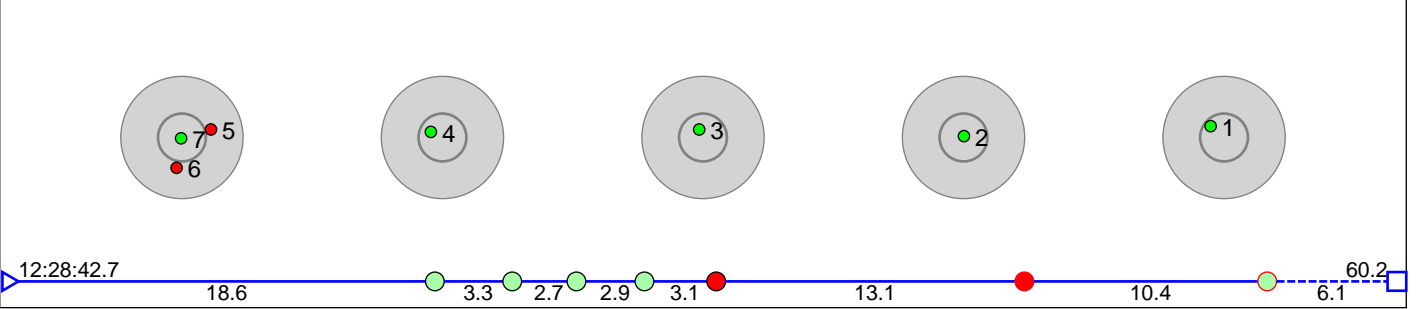

Shooting 6 - Standing at lane 9 8 shots at 50.5s Result: 0 + 3

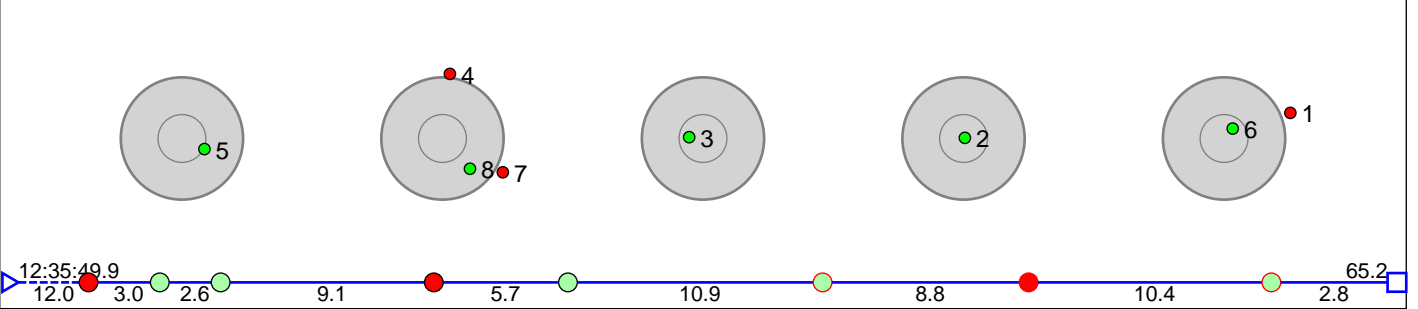

Shooting 7 - Prone at lane 8 7 shots at 29.1s Result: 0 + 2

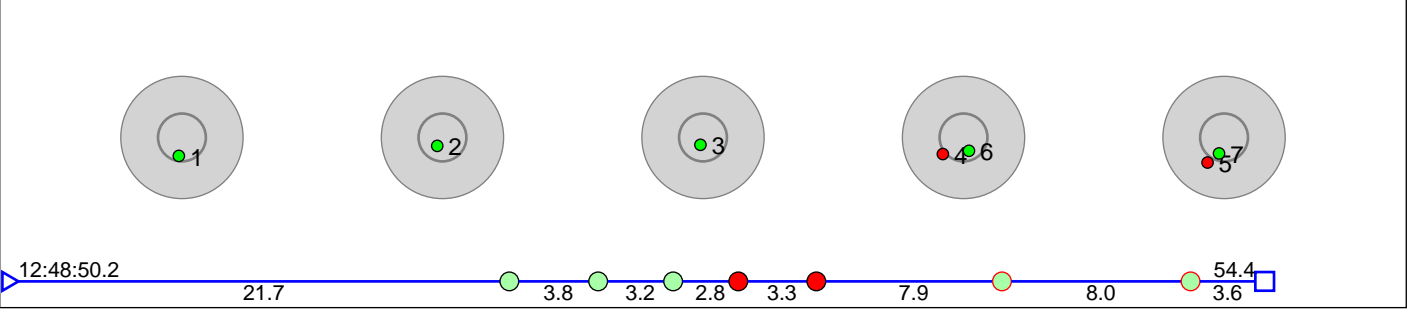

Shooting 8 - Standing at lane 10 7 shots at 30.7s Result: 0 + 2

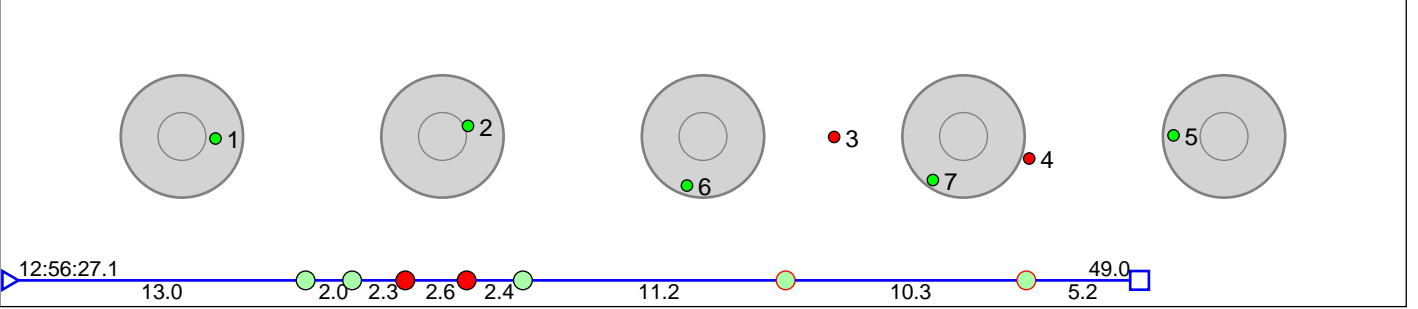

Disclaimer:

These results are unofficial since only the final output from the timing system can provide complete and correct competition results. The graphic plot of each series, presents the location of the shots on each of the five targets. Please observe that the accuracy of the plotting has some limitations due to image resolution and/or printer quality.

65 Sogn og Fjordane SSK 1

Sogn og Fjordane SSK

Result: 12

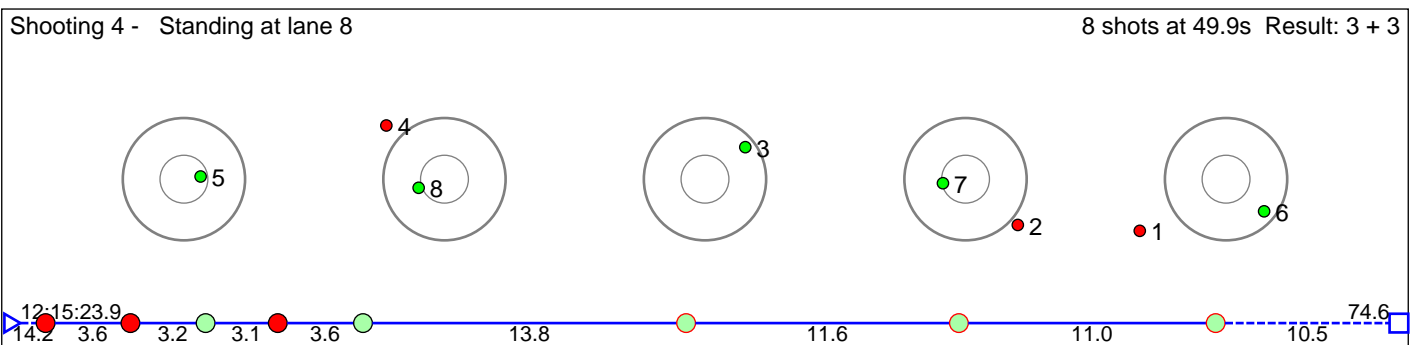
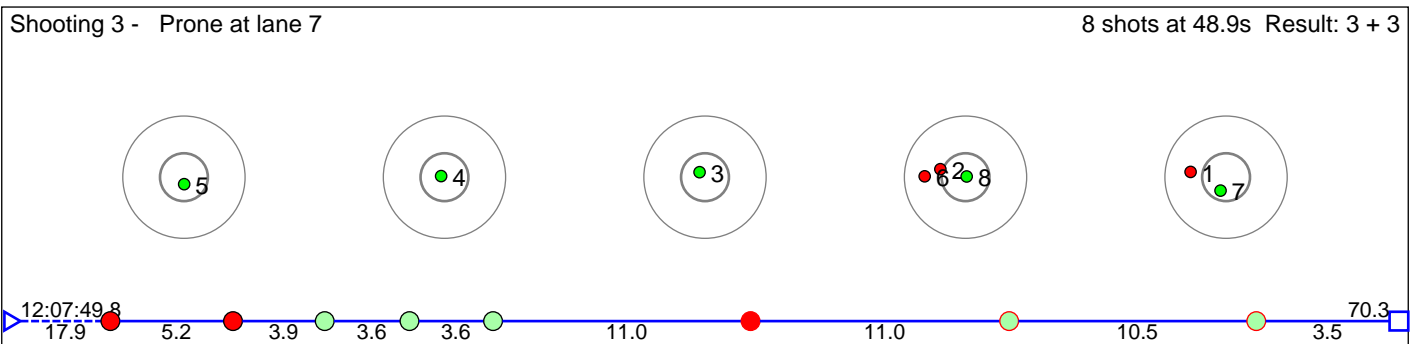
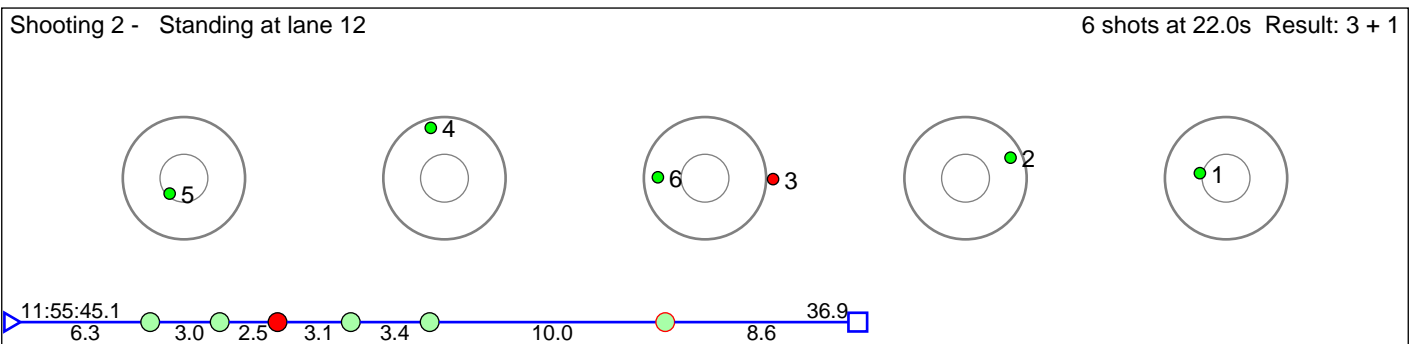
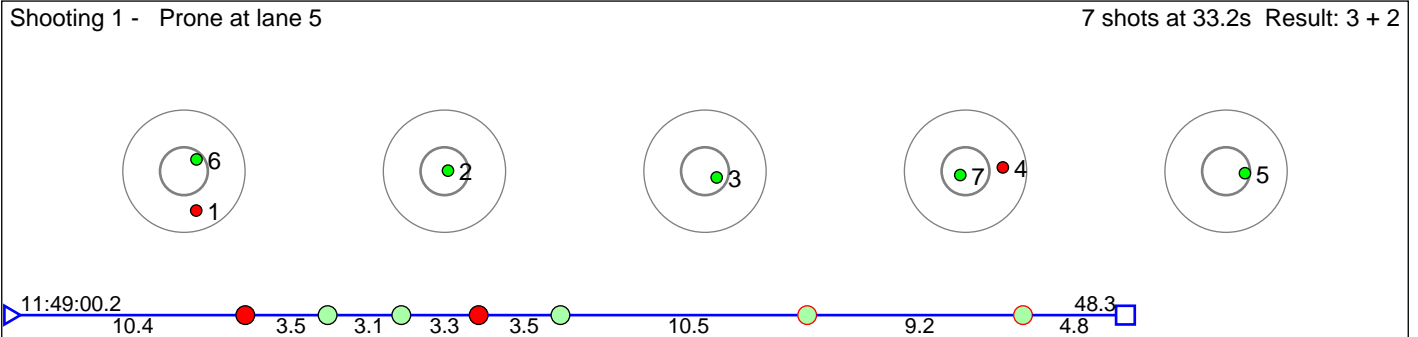

Shooting 5 - Prone at lane 13 8 shots at 52.8s Result: 0 + 3

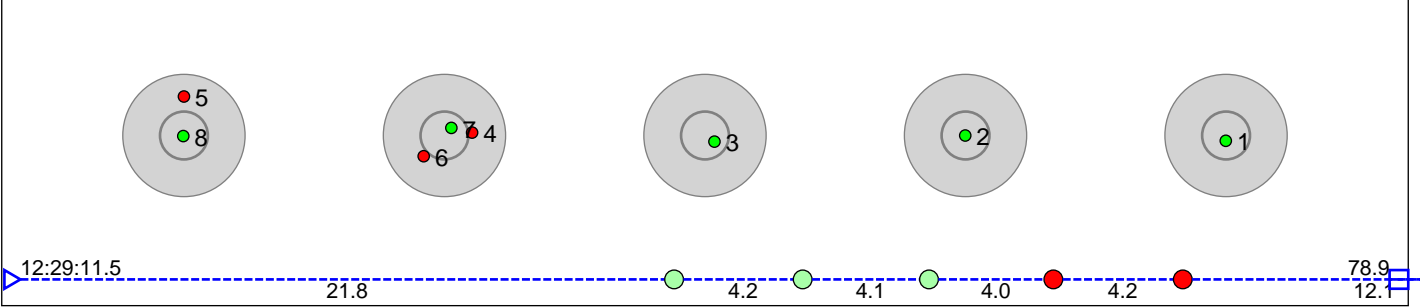

Shooting 6 - Standing at lane 20 7 shots at 38.0s Result: 0 + 2

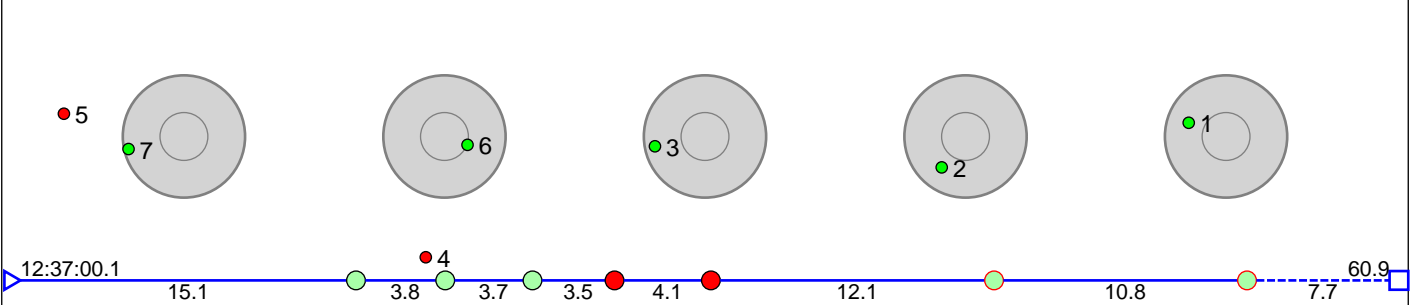

Shooting 7 - Prone at lane 20 7 shots at 24.6s Result: 0 + 2

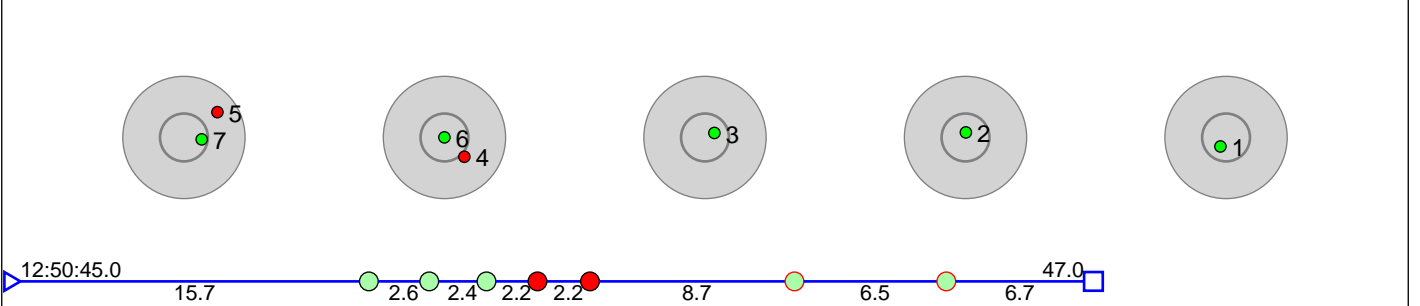

Shooting 8 - Standing at lane 16 5 shots at 8.1s Result: 0 + 0

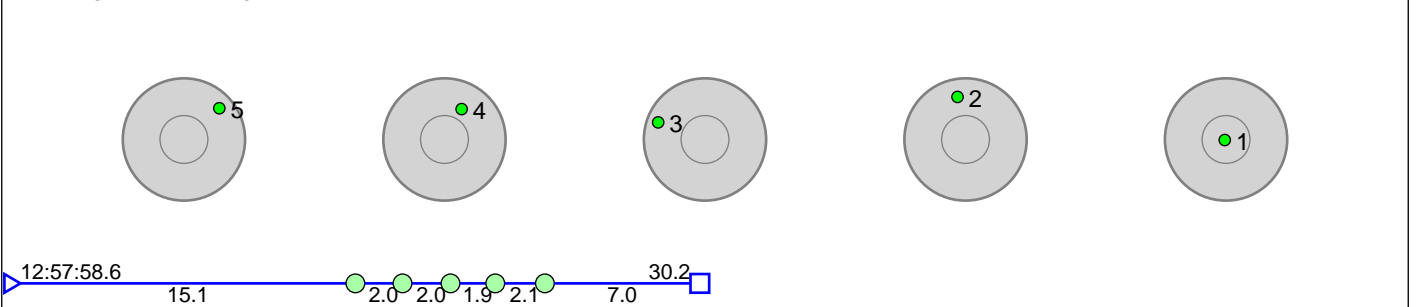

Disclaimer:

These results are unofficial since only the final output from the timing system can provide complete and correct competition results. The graphic plot of each series, presents the location of the shots on each of the five targets. Please observe that the accuracy of the plotting has some limitations due to image resolution and/or printer quality.

66 Nord-Østerdal SSK 1

Nord-Østerdal SSK

Result: 16

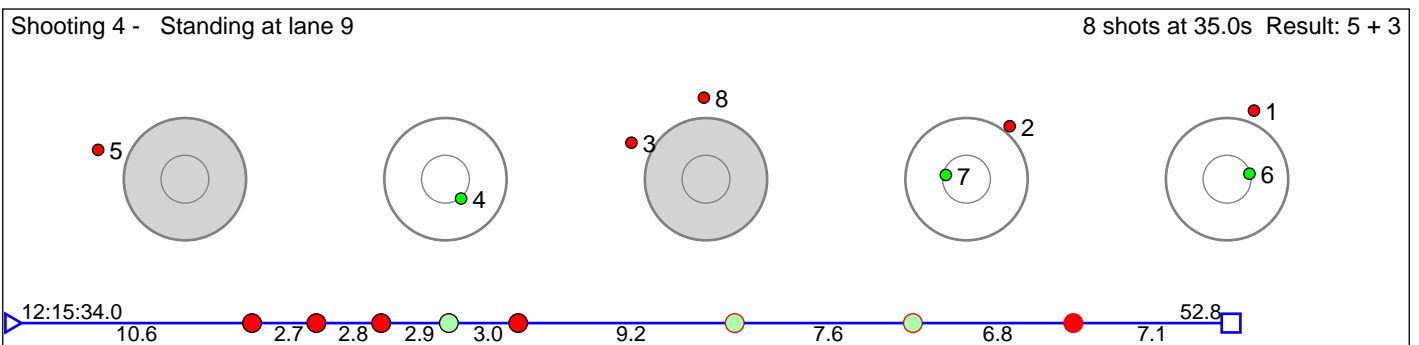
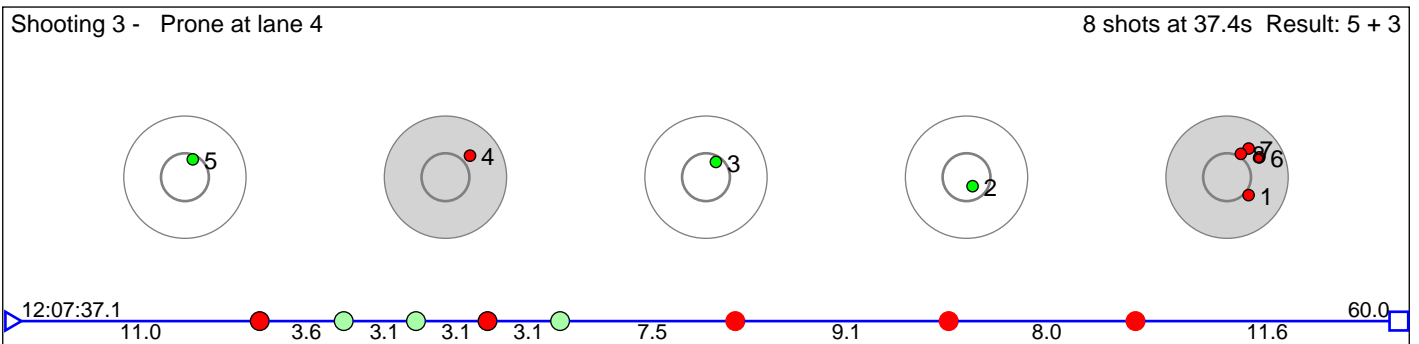
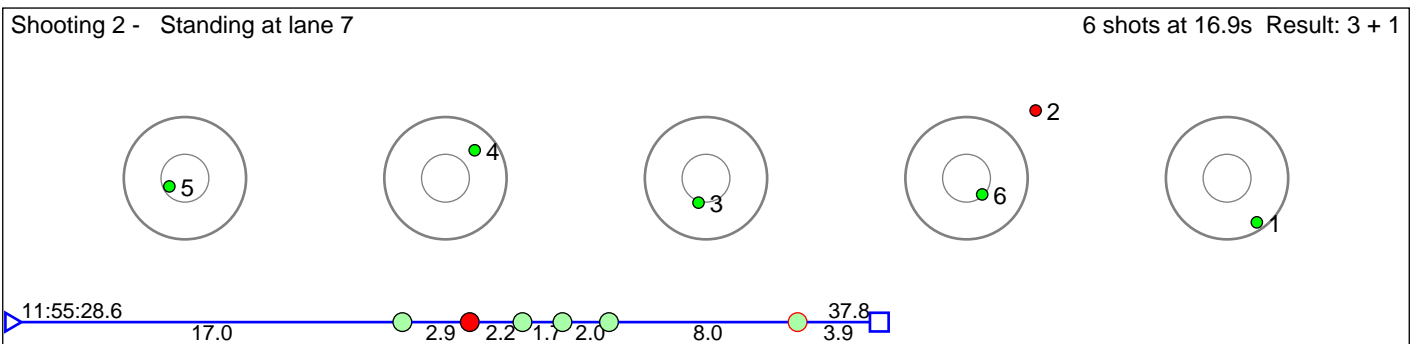
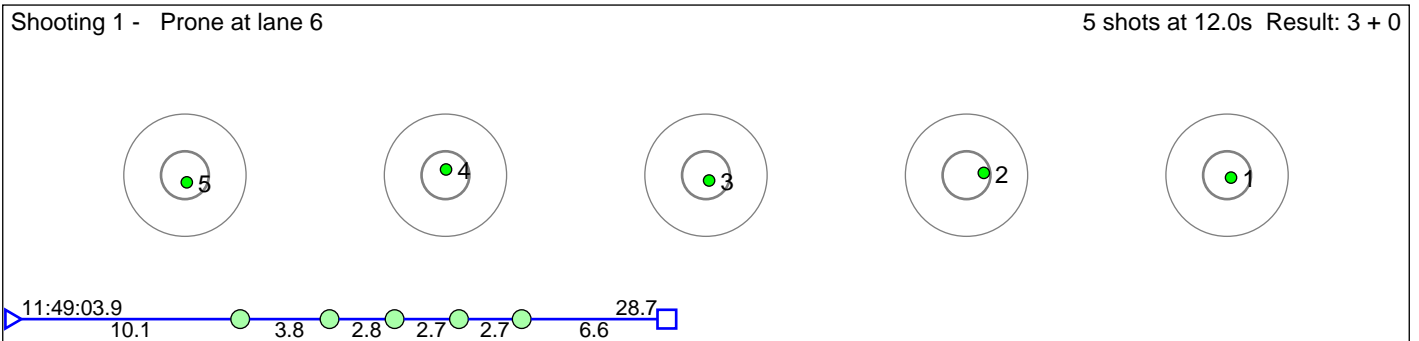

Shooting 5 - Prone at lane 14 7 shots at 38.9s Result: 0 + 2

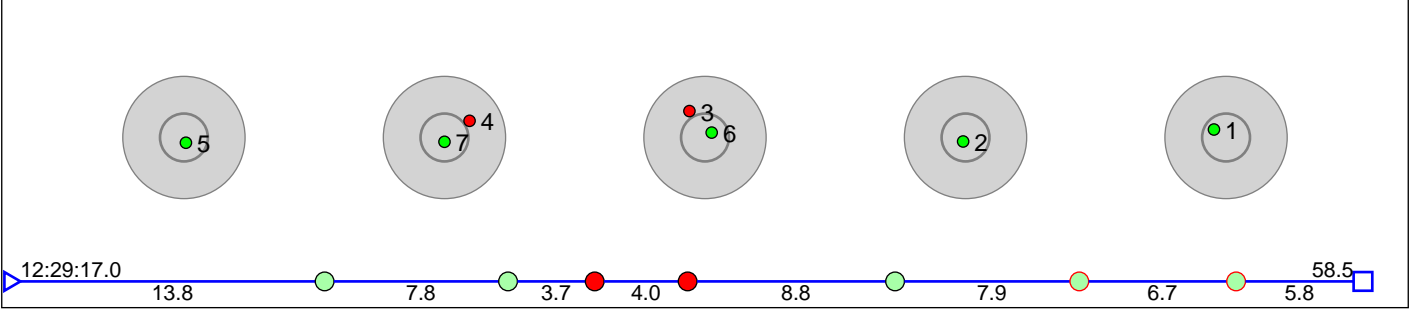

Shooting 6 - Standing at lane 19 6 shots at 24.7s Result: 0 + 1

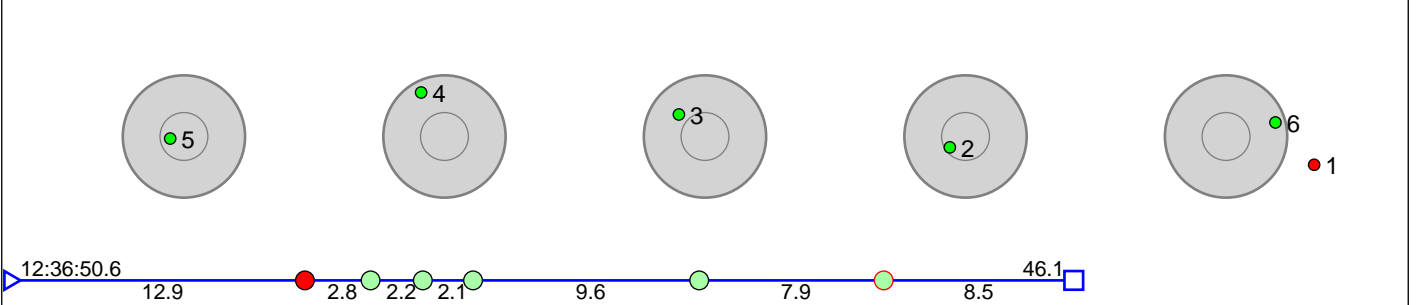

Shooting 7 - Prone at lane 16 8 shots at 53.5s Result: 0 + 3

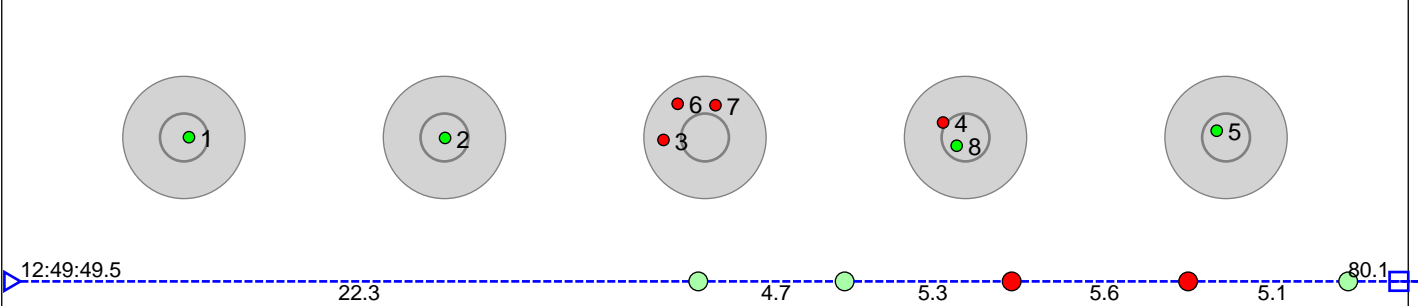

Shooting 8 - Standing at lane 14 8 shots at 62.2s Result: 0 + 3

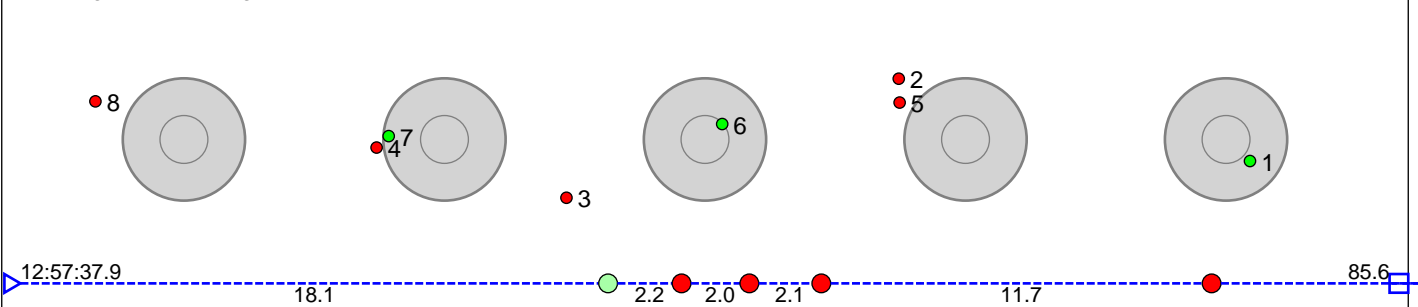

Disclaimer:

These results are unofficial since only the final output from the timing system can provide complete and correct competition results. The graphic plot of each series, presents the location of the shots on each of the five targets. Please observe that the accuracy of the plotting has some limitations due to image resolution and/or printer quality.

67 Telemark og Vestfold SSK 1

Telemark og Vestfold SSK

Result: 15

Shooting 1 - Prone at lane 7

5 shots at 8.5s Result: 3 + 0

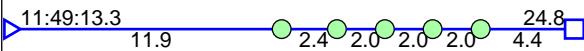
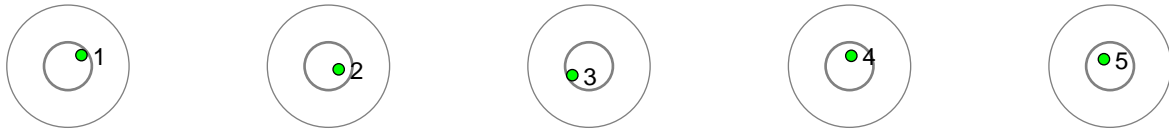

Shooting 2 - Standing at lane 17

7 shots at 21.9s Result: 3 + 2

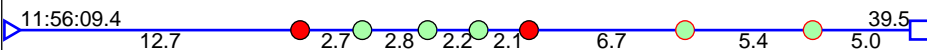
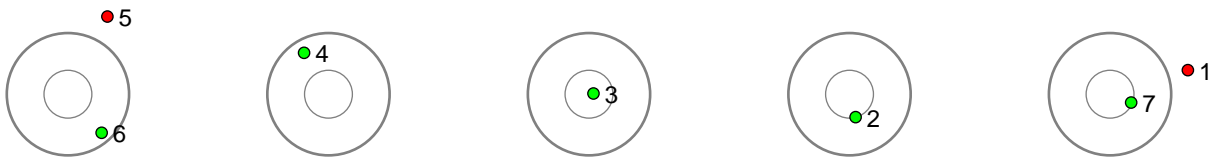

Shooting 3 - Prone at lane 19

8 shots at 41.2s Result: 6 + 3

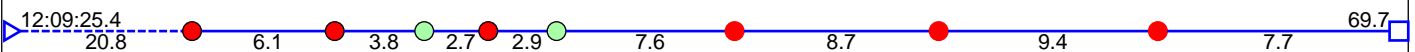
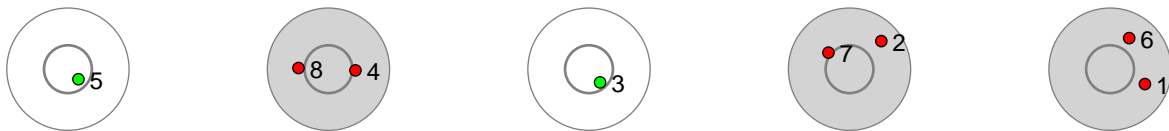

Shooting 4 - Standing at lane 25

7 shots at 34.0s Result: 3 + 2

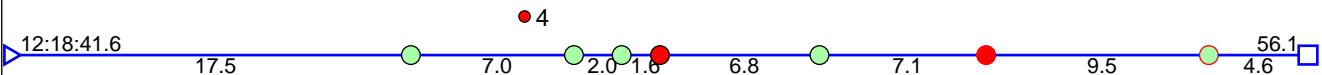
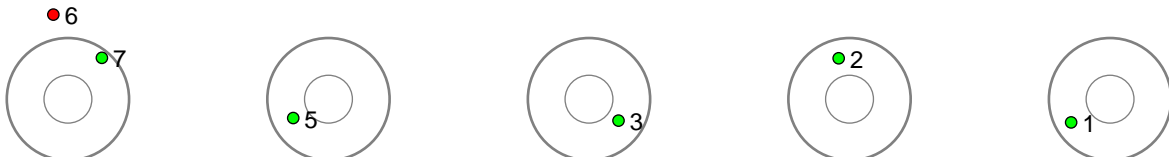

Shooting 5 - Prone at lane 26 8 shots at 67.5s Result: 0 + 3

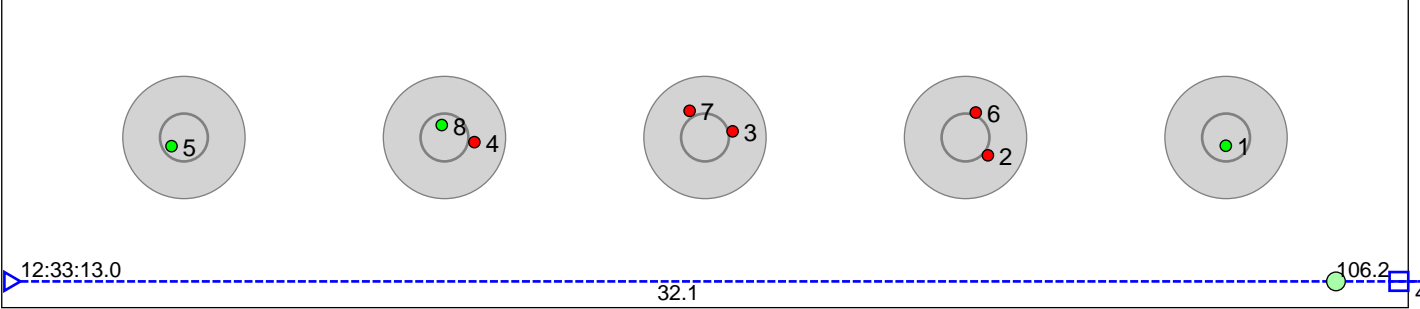

Shooting 6 - Standing at lane 25 8 shots at 43.7s Result: 0 + 3

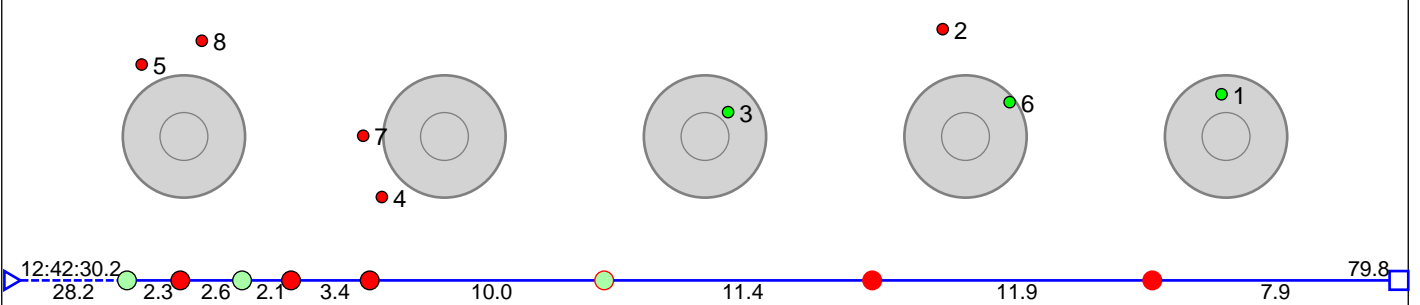

Shooting 7 - Prone at lane 25 6 shots at 21.4s Result: 0 + 1

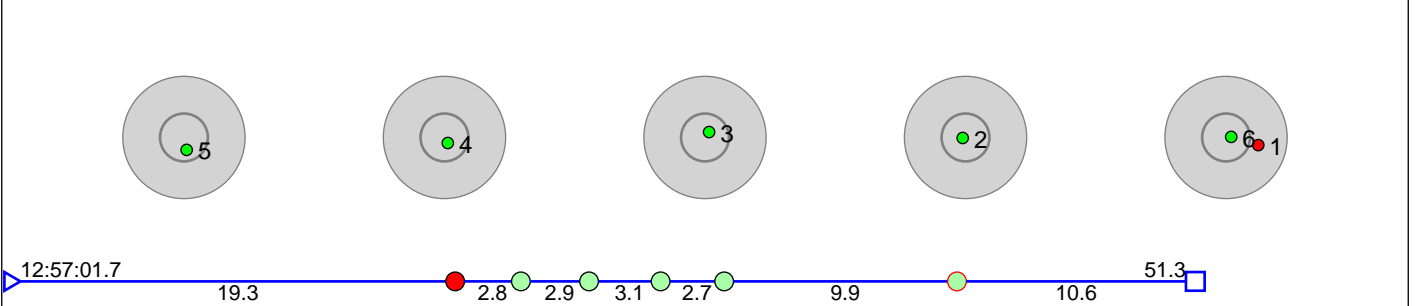

Shooting 8 - Standing at lane 25 7 shots at 21.1s Result: 0 + 2

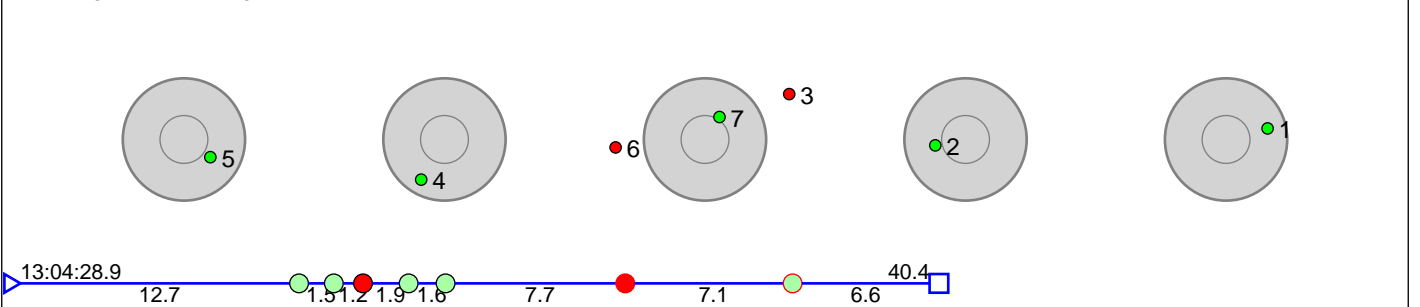

Disclaimer:

These results are unofficial since only the final output from the timing system can provide complete and correct competition results. The graphic plot of each series, presents the location of the shots on each of the five targets. Please observe that the accuracy of the plotting has some limitations due to image resolution and/or printer quality.

68 Nordland SSK 1

Nordland SSK

Result: 13

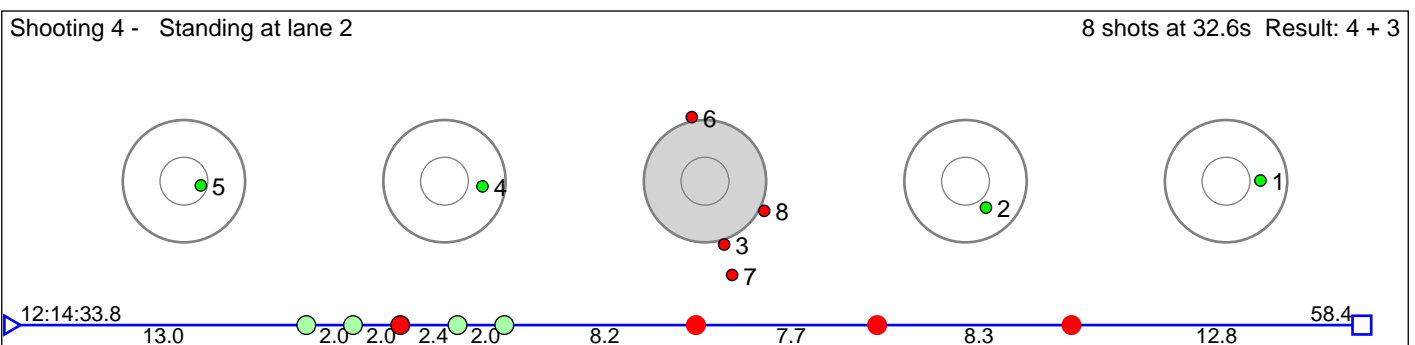
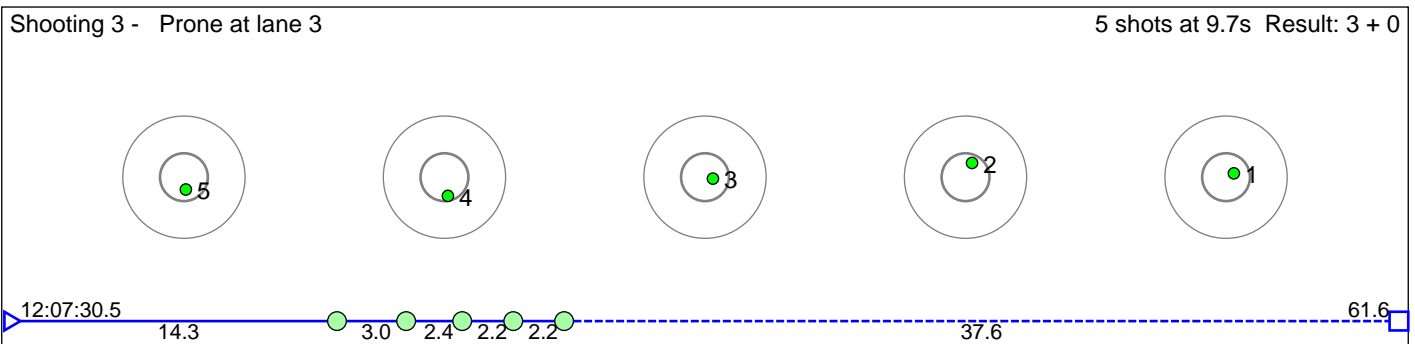
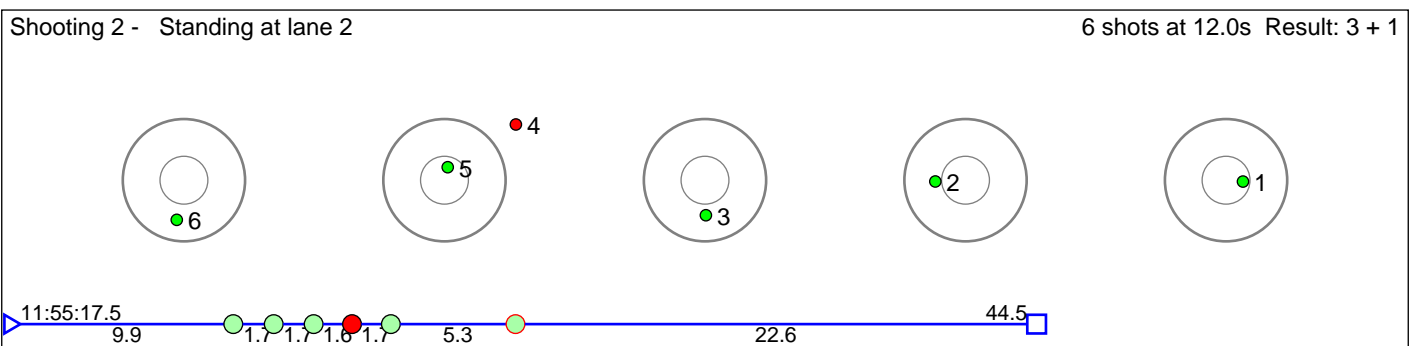
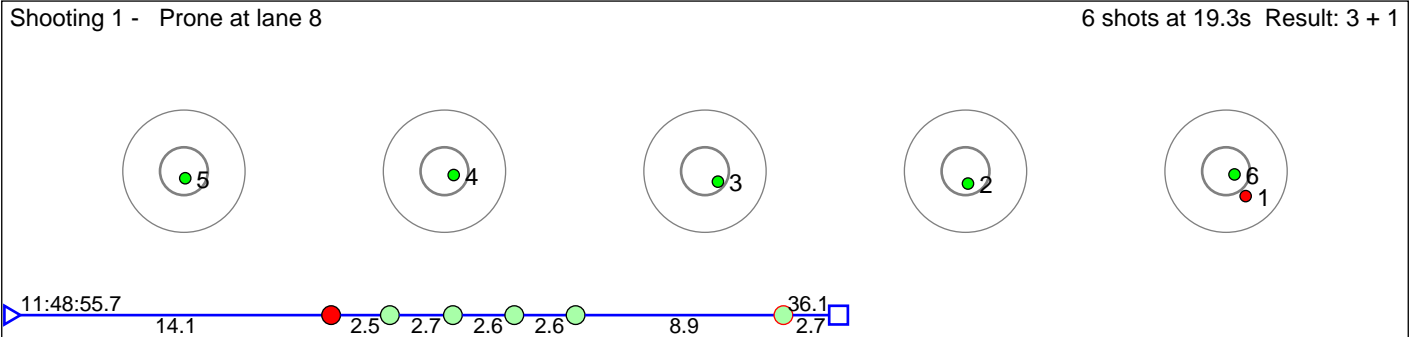

Shooting 5 - Prone at lane 9 7 shots at 34.7s Result: 0 + 2

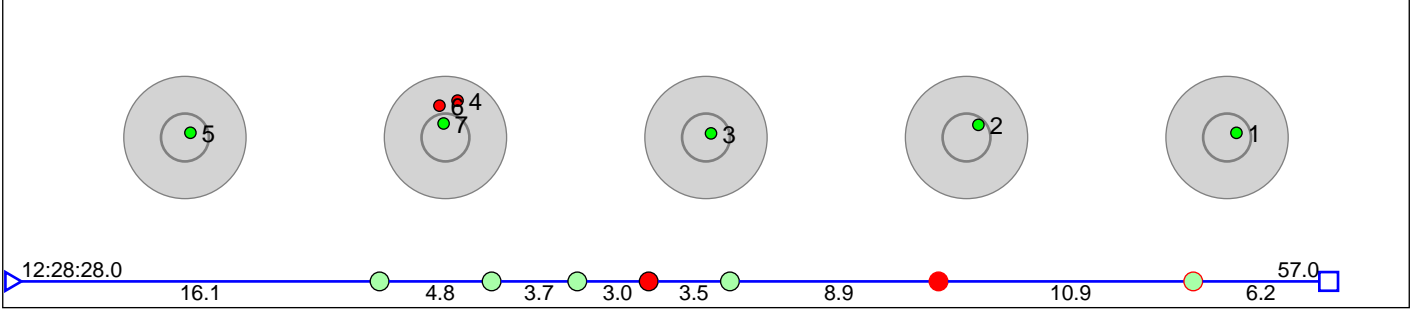

Shooting 6 - Standing at lane 11 8 shots at 34.5s Result: 0 + 3

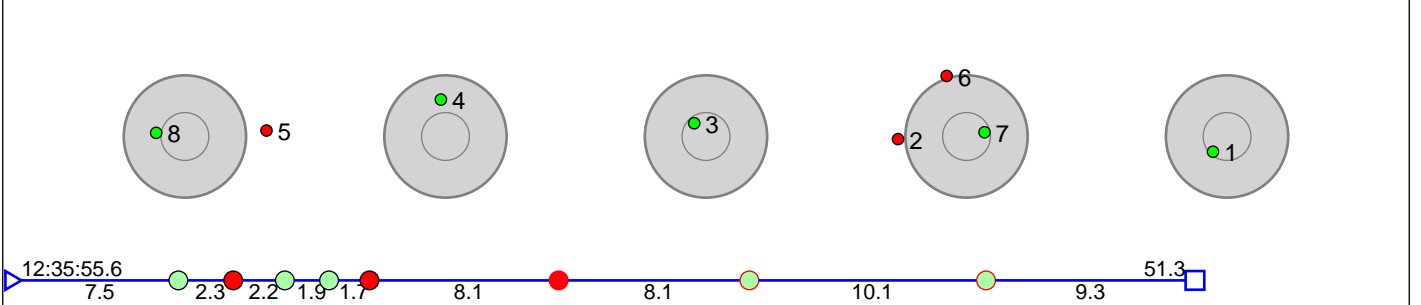

Shooting 7 - Prone at lane 12 5 shots at 9.6s Result: 0 + 0

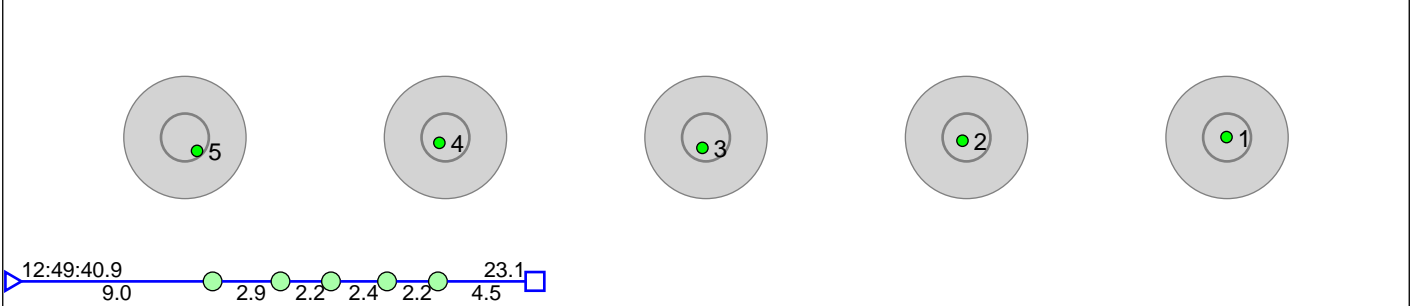

Shooting 8 - Standing at lane 11 8 shots at 43.5s Result: 0 + 3

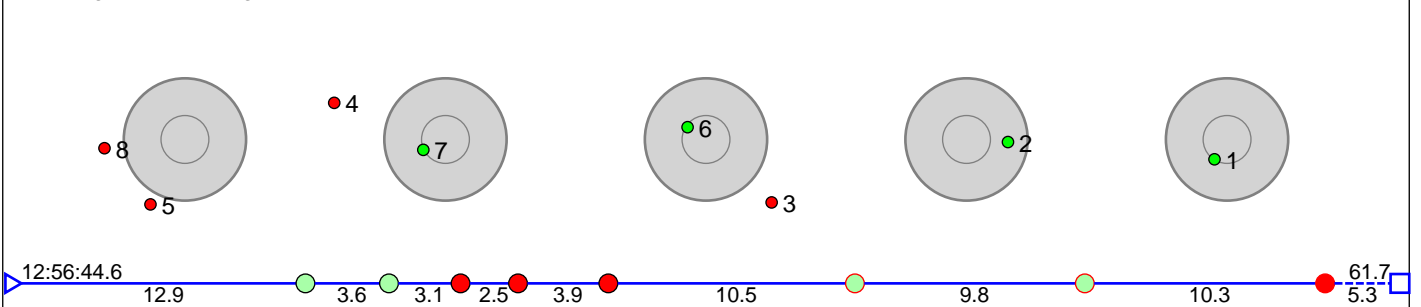

Disclaimer:

These results are unofficial since only the final output from the timing system can provide complete and correct competition results. The graphic plot of each series, presents the location of the shots on each of the five targets. Please observe that the accuracy of the plotting has some limitations due to image resolution and/or printer quality.

69 Nord-Trøndelag SSK 1

Nord-Trøndelag SSK

Result: 12

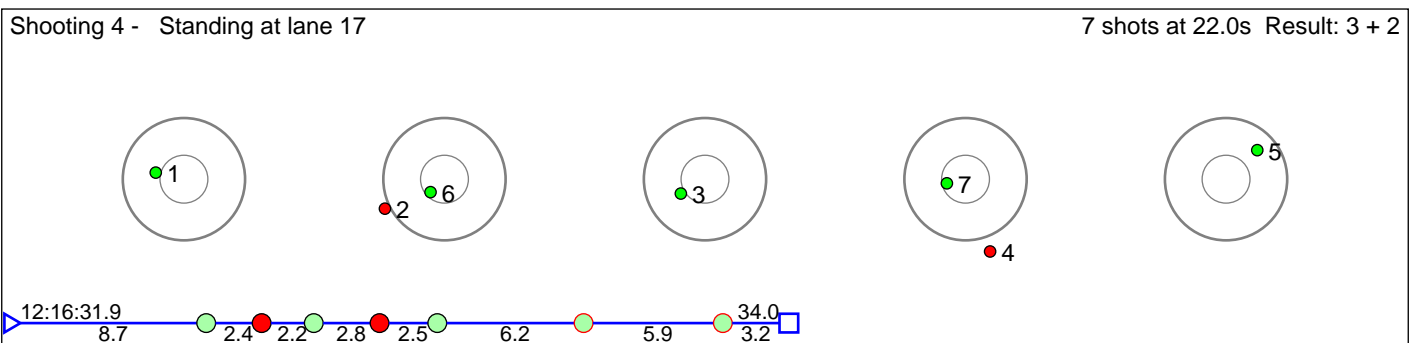
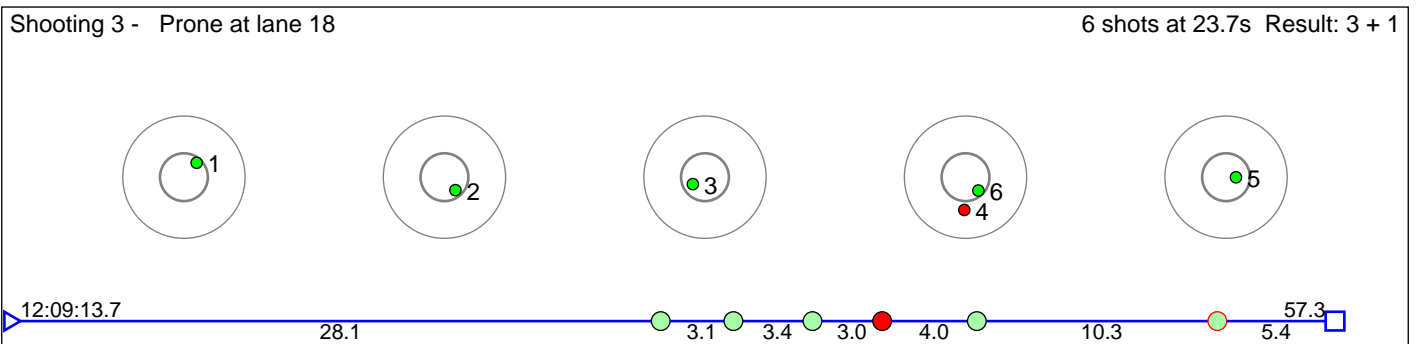
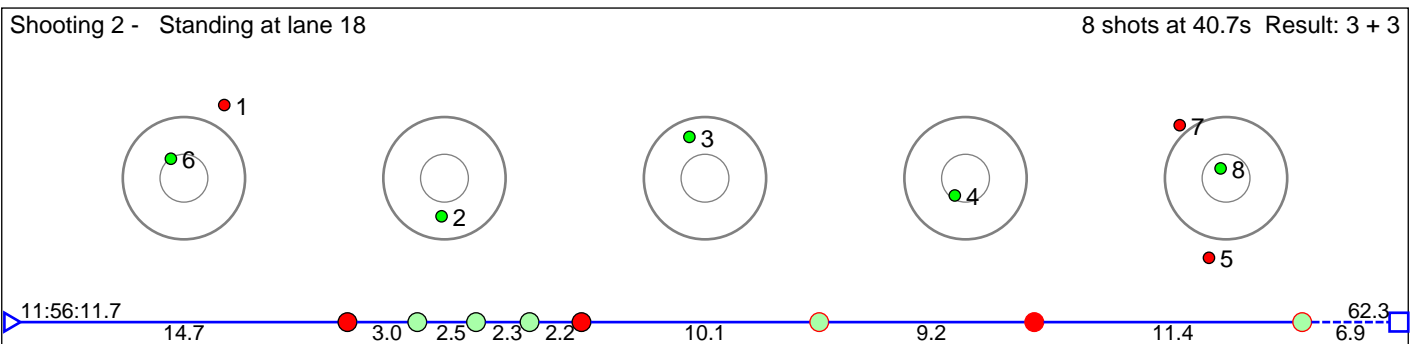
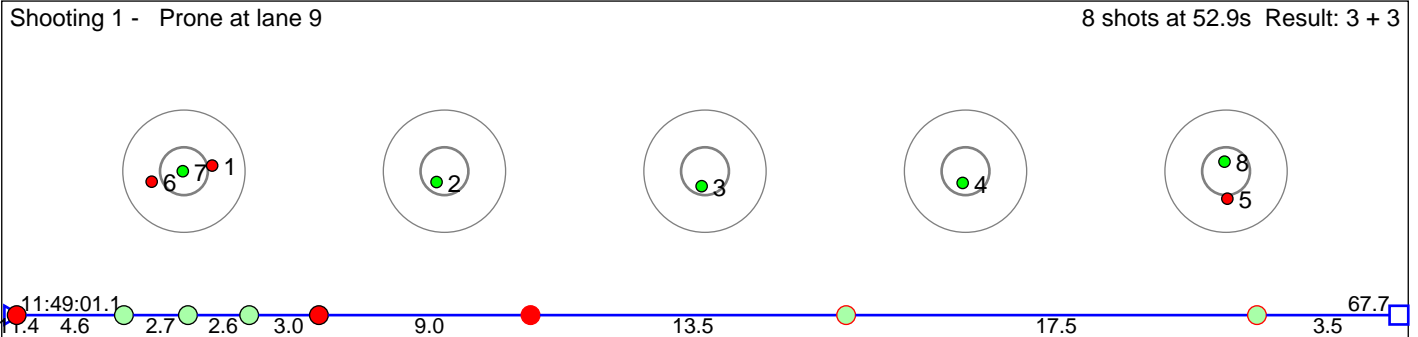

Shooting 5 - Prone at lane 17 5 shots at 12.0s Result: 0 + 0

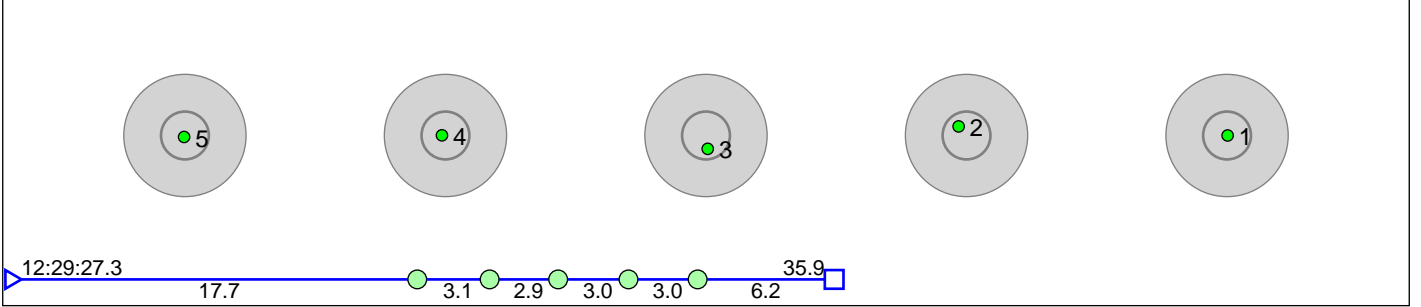

Shooting 6 - Standing at lane 17 6 shots at 29.2s Result: 0 + 1

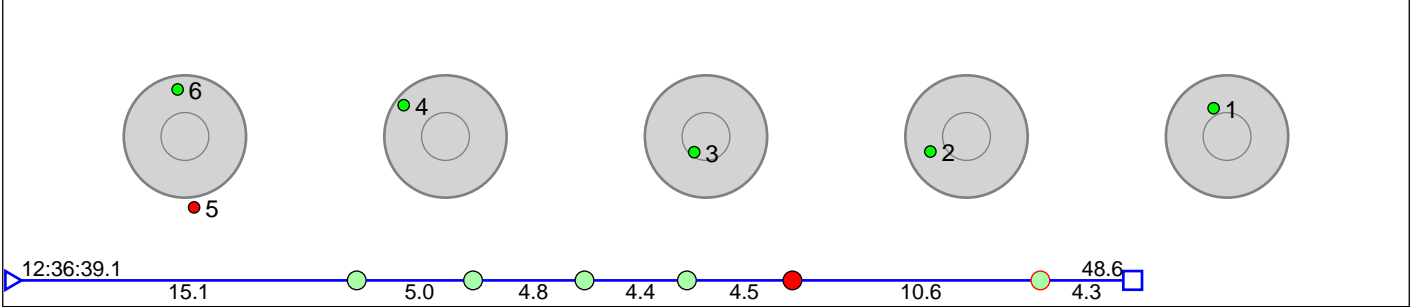

Shooting 7 - Prone at lane 18 9 shots at 59.8s Result: 0 + 4

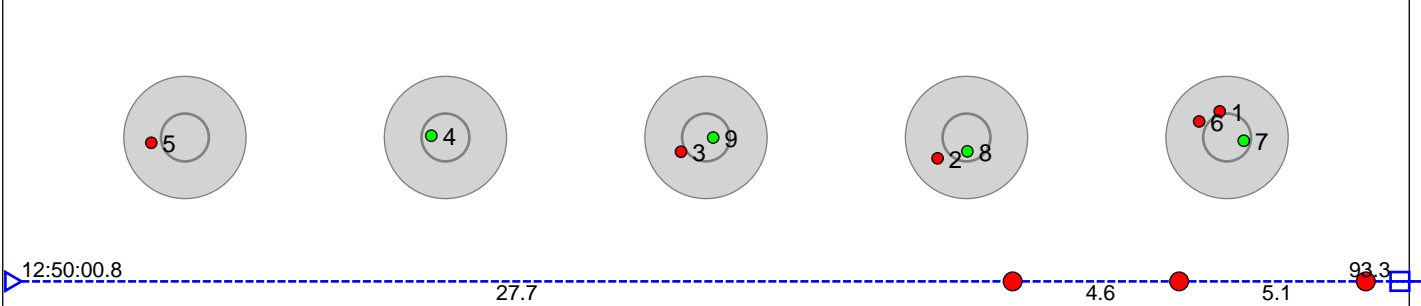

Shooting 8 - Standing at lane 19 8 shots at 52.7s Result: 0 + 3

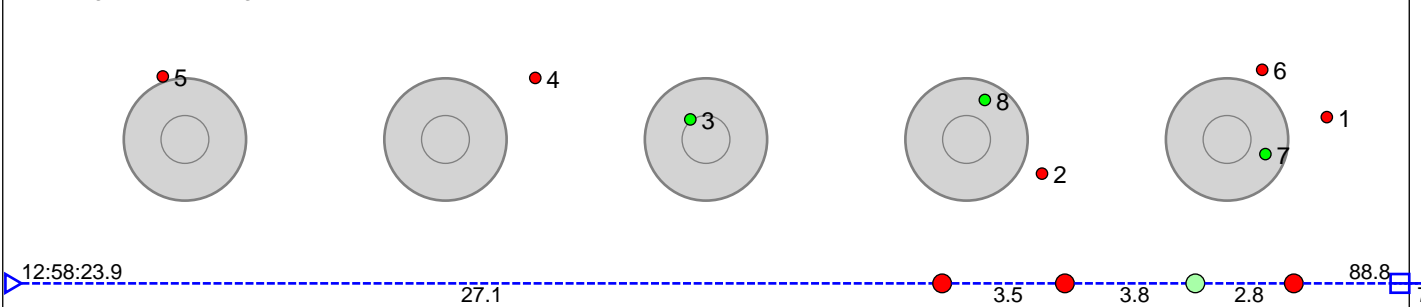

Disclaimer:

These results are unofficial since only the final output from the timing system can provide complete and correct competition results. The graphic plot of each series, presents the location of the shots on each of the five targets. Please observe that the accuracy of the plotting has some limitations due to image resolution and/or printer quality.

70 Sør-Trøndelag SSK 1

Sør-Trøndelag SSK

Result: 12

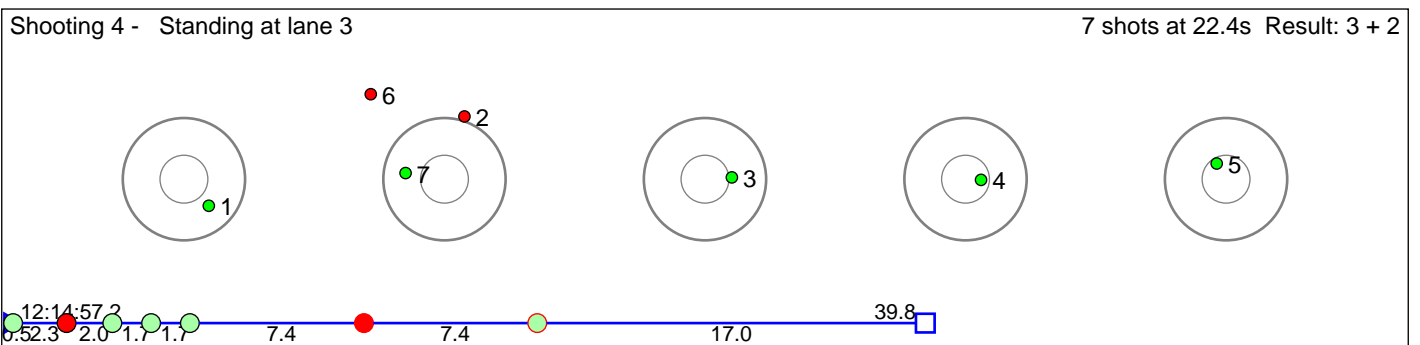
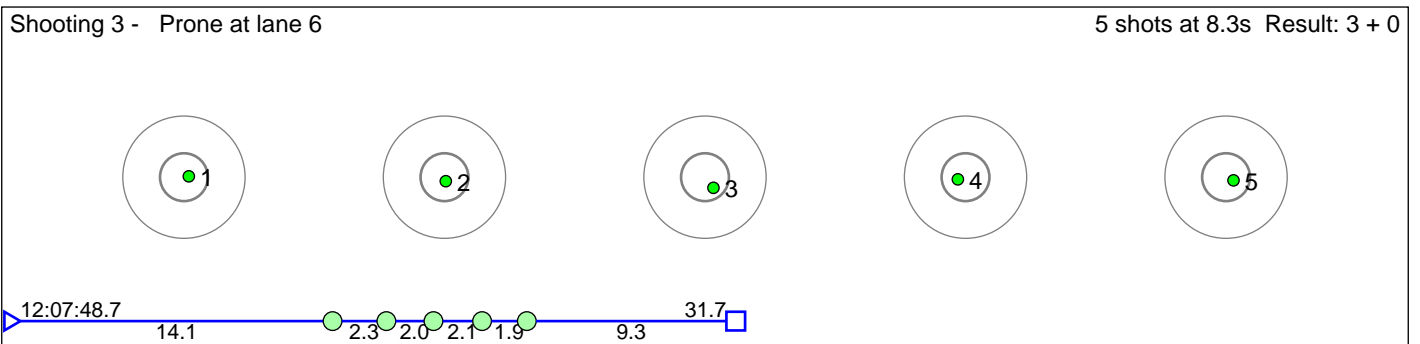
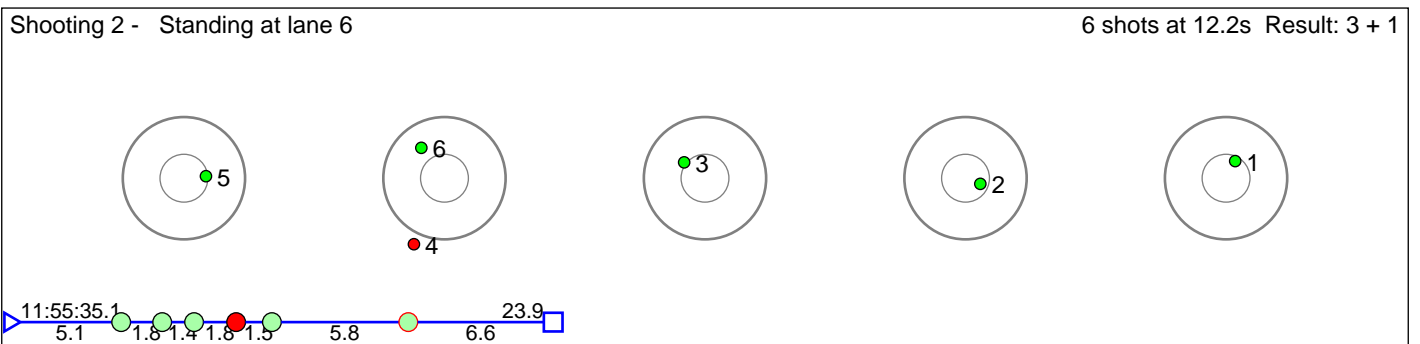
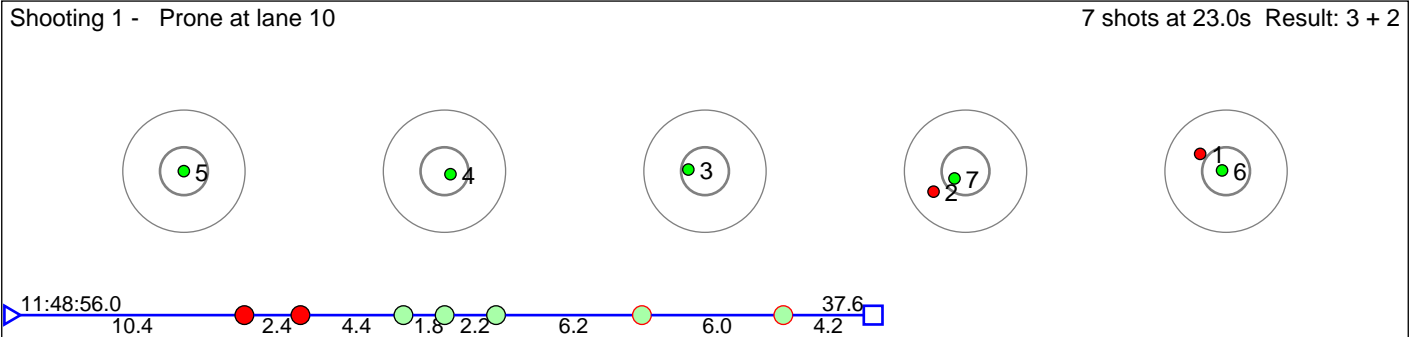

Shooting 5 - Prone at lane 4 7 shots at 47.7s Result: 0 + 2

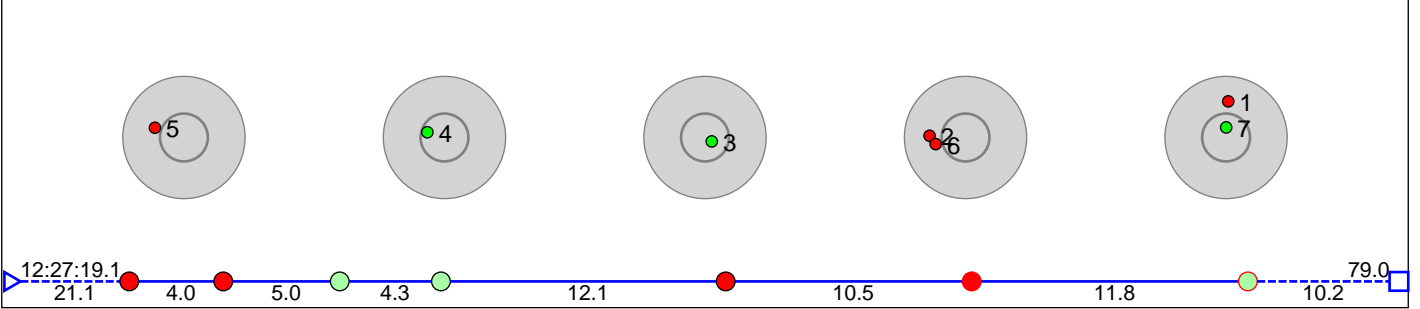

Shooting 6 - Standing at lane 8 7 shots at 35.1s Result: 0 + 2

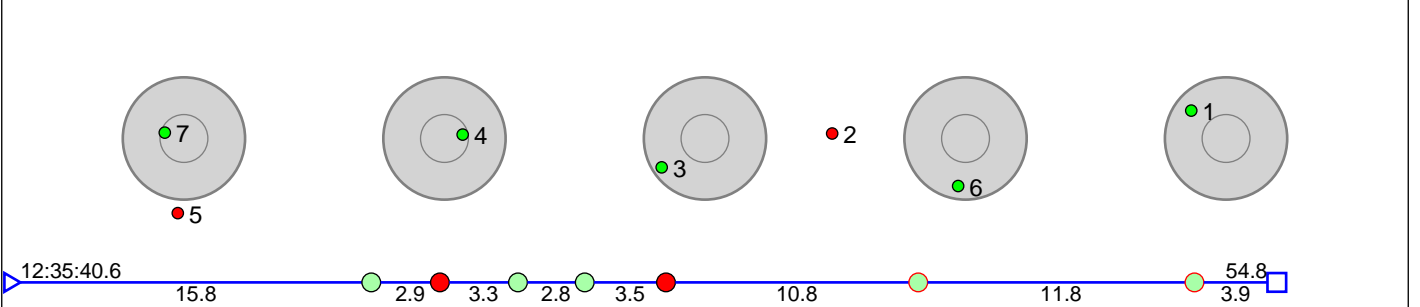

Shooting 7 - Prone at lane 10 5 shots at 10.9s Result: 0 + 0

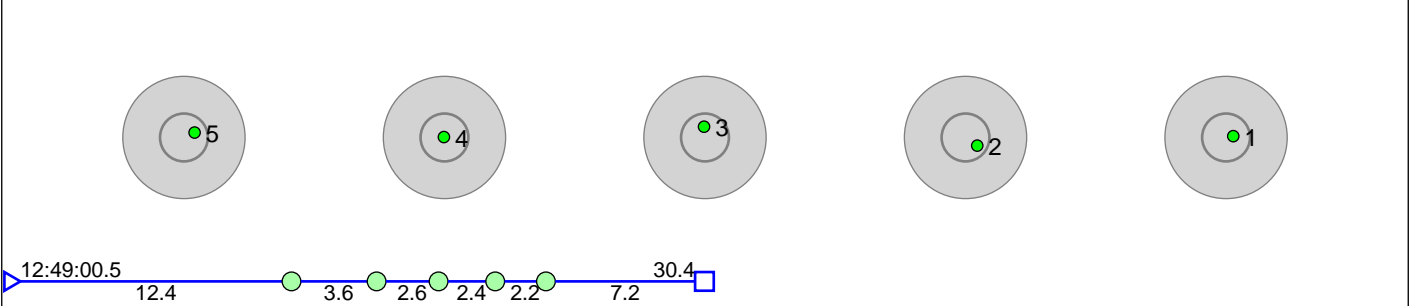

Shooting 8 - Standing at lane 9 6 shots at 17.9s Result: 0 + 1

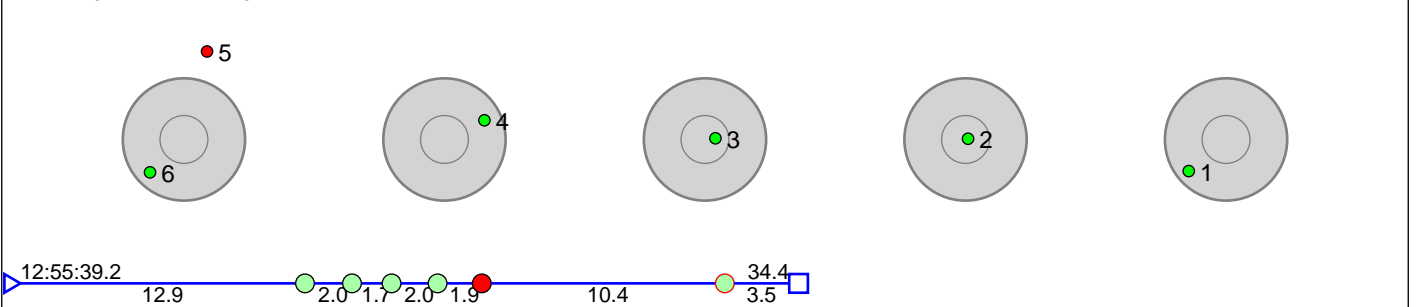

Disclaimer:

These results are unofficial since only the final output from the timing system can provide complete and correct competition results. The graphic plot of each series, presents the location of the shots on each of the five targets. Please observe that the accuracy of the plotting has some limitations due to image resolution and/or printer quality.

71 Buskerud SSK 1

Buskerud SSK

Result: 12

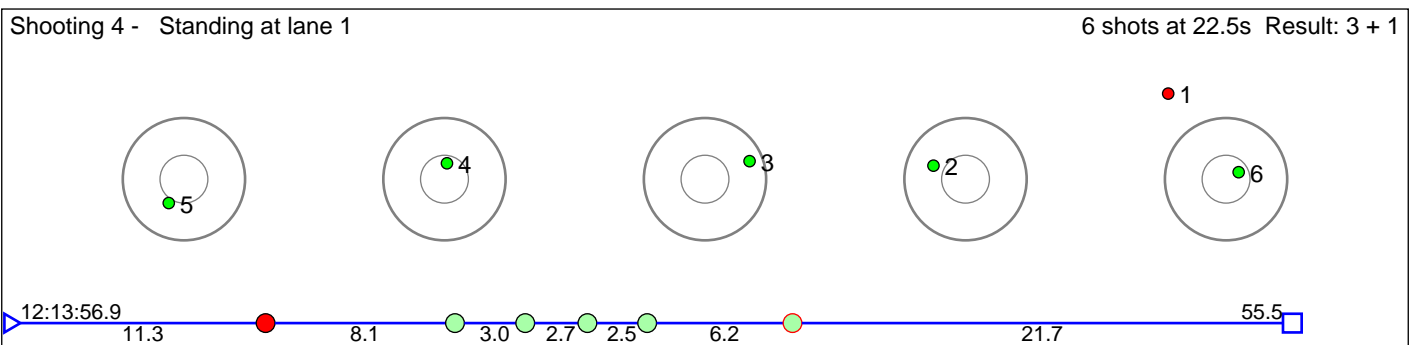
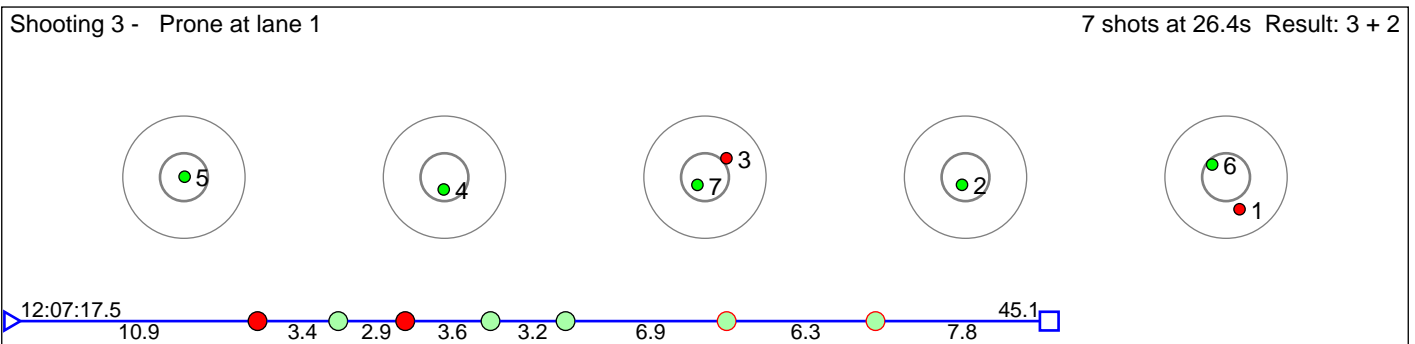
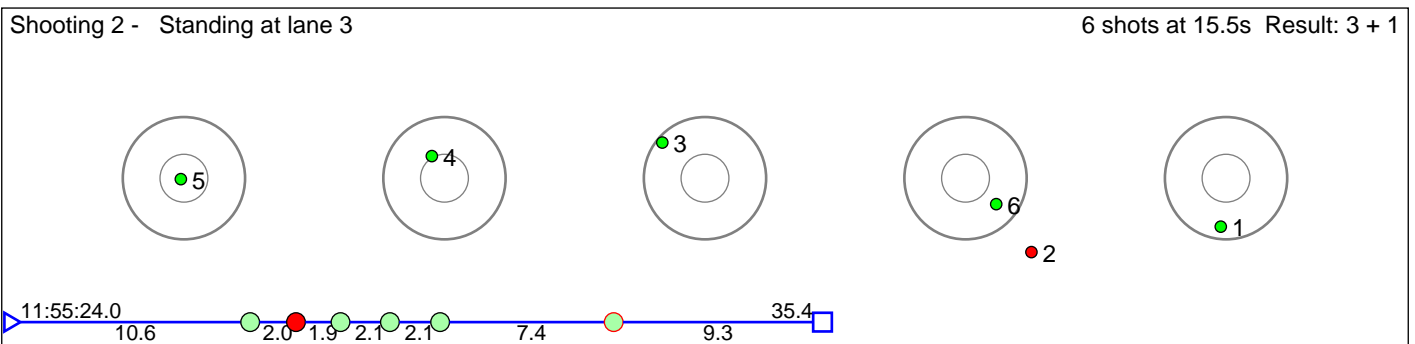
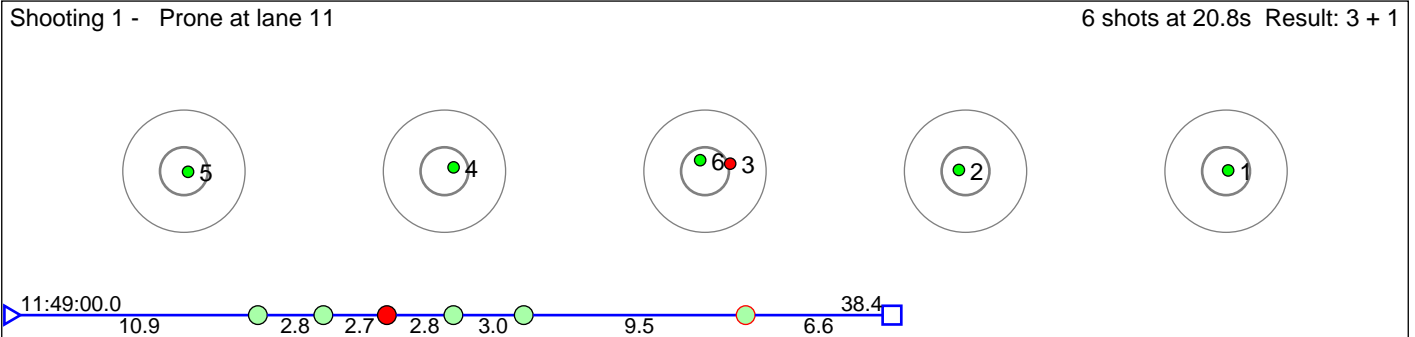

Shooting 5 - Prone at lane 1 6 shots at 21.9s Result: 0 + 1

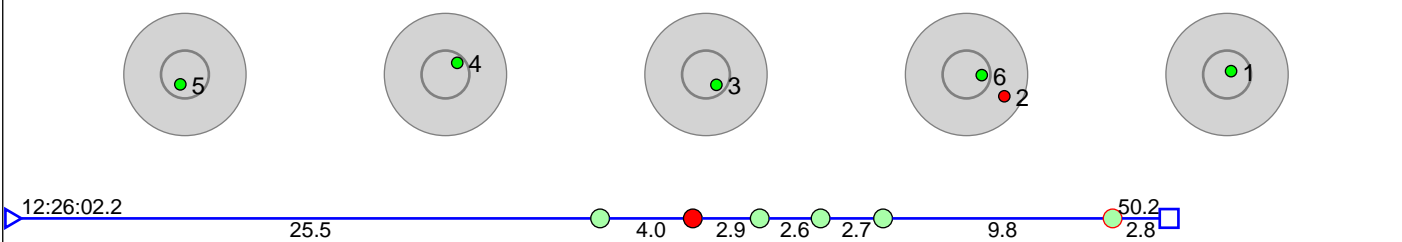

Shooting 6 - Standing at lane 1 8 shots at 46.0s Result: 0 + 3

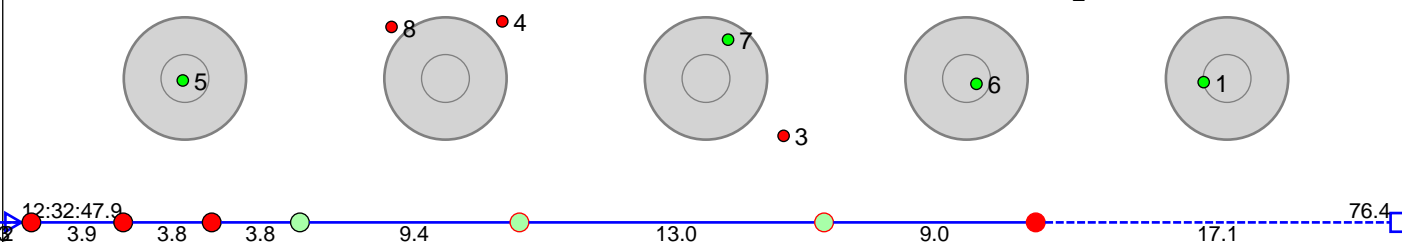

Shooting 7 - Prone at lane 1 5 shots at 12.6s Result: 0 + 0

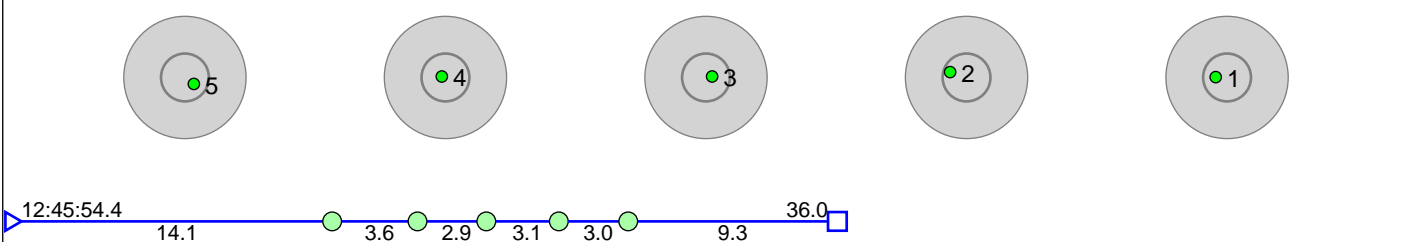

Shooting 8 - Standing at lane 1 6 shots at 15.2s Result: 0 + 1

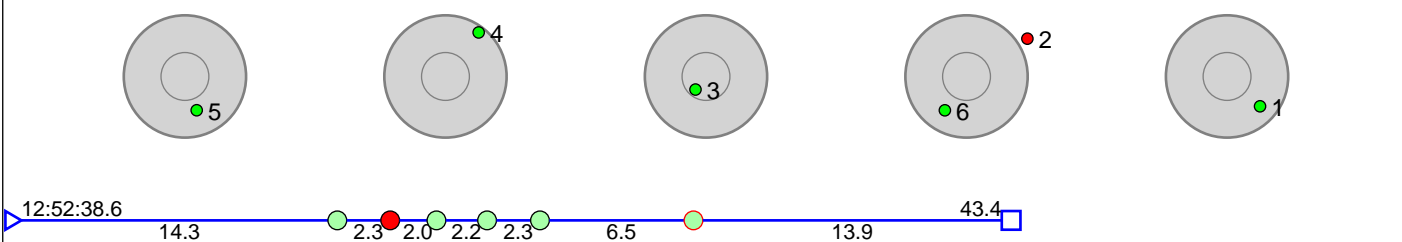

Disclaimer:

These results are unofficial since only the final output from the timing system can provide complete and correct competition results. The graphic plot of each series, presents the location of the shots on each of the five targets. Please observe that the accuracy of the plotting has some limitations due to image resolution and/or printer quality.

72 Hordaland SSK 1

Hordaland SSK

Result: 13

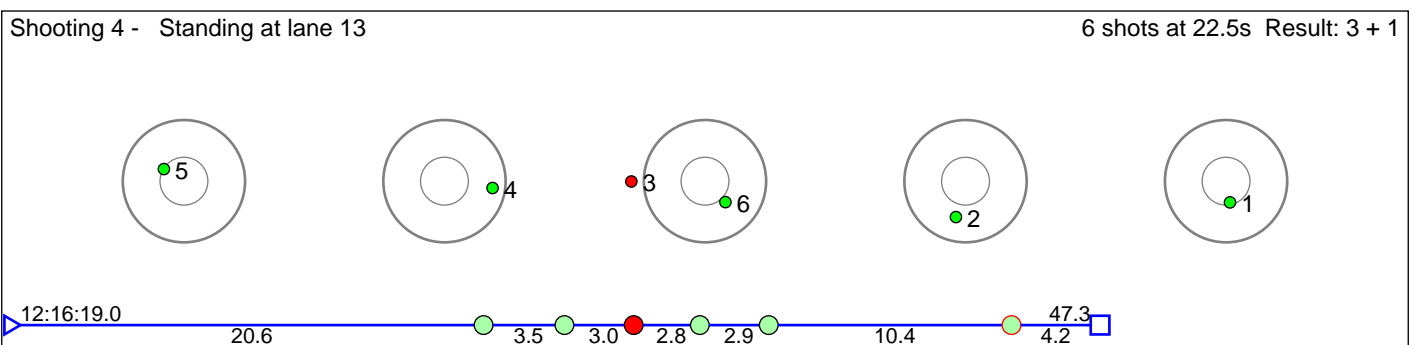
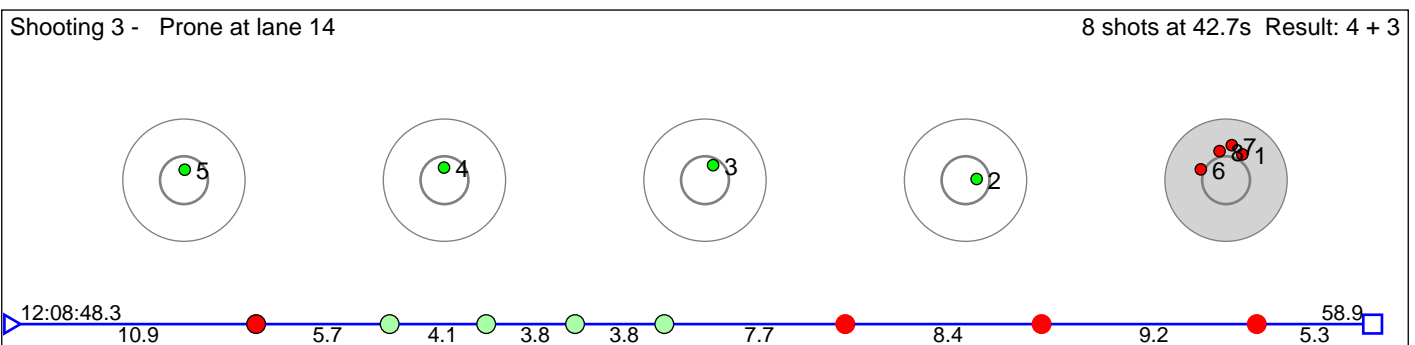
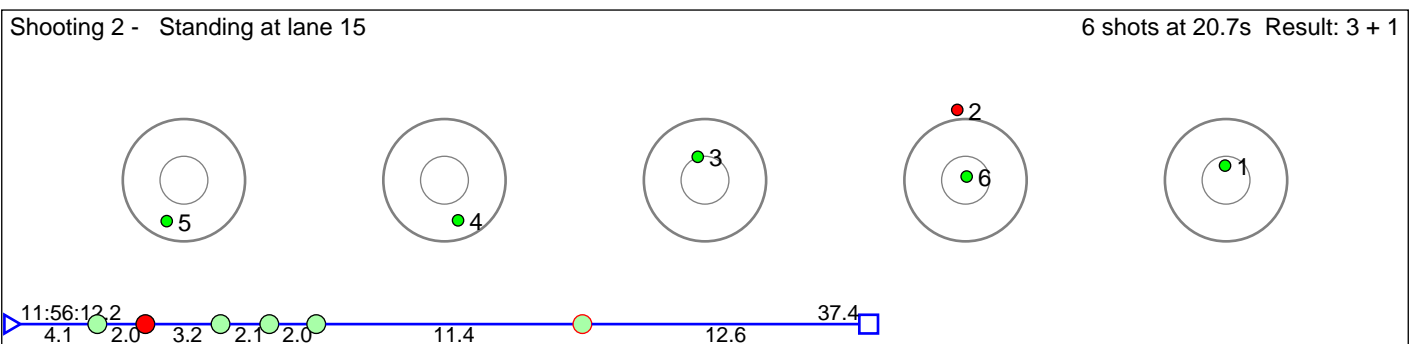
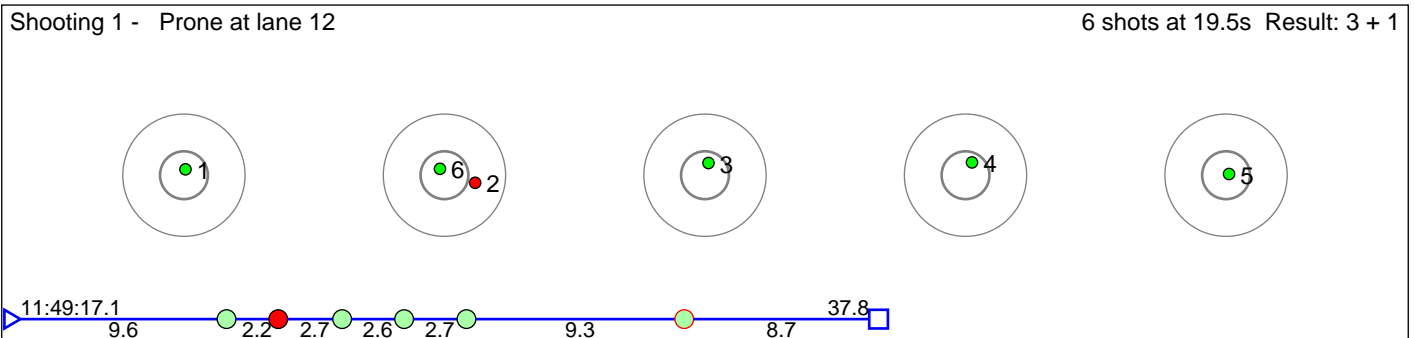

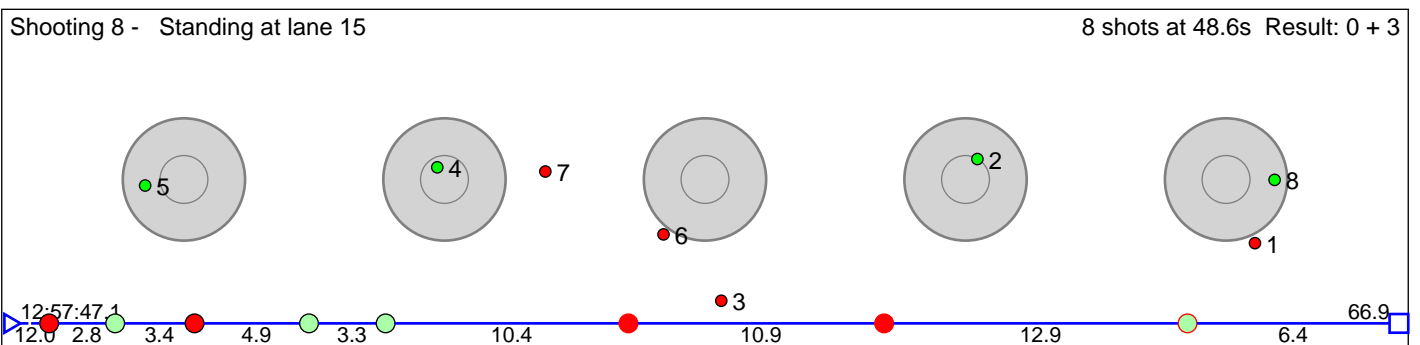
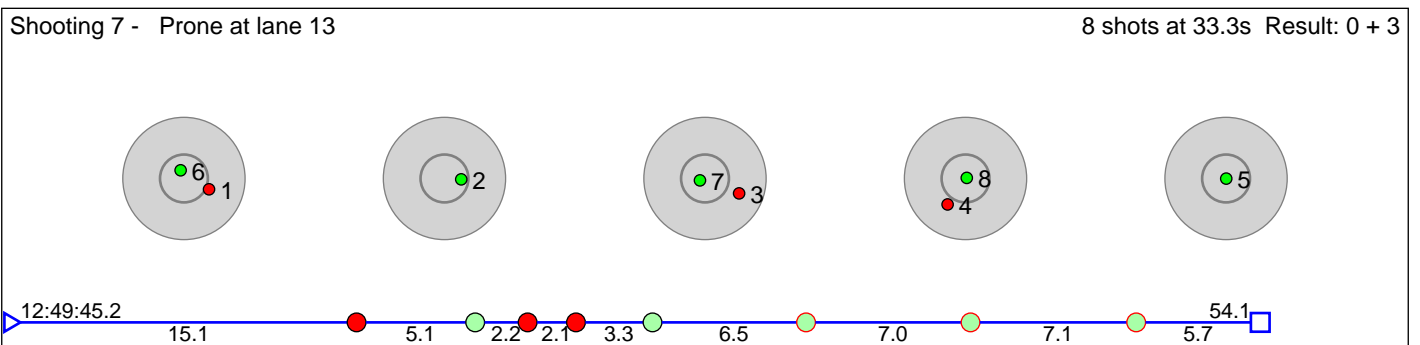
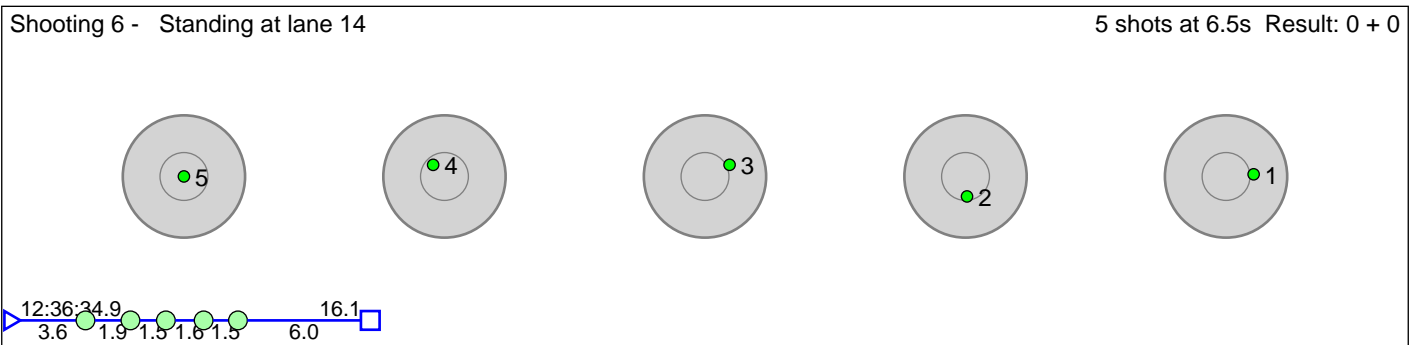
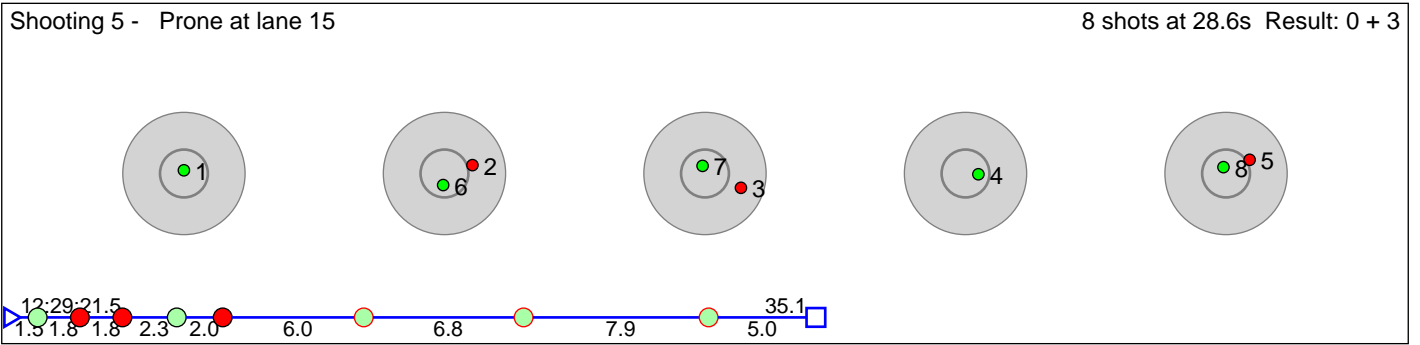

Disclaimer:

These results are unofficial since only the final output from the timing system can provide complete and correct competition results. The graphic plot of each series, presents the location of the shots on each of the five targets. Please observe that the accuracy of the plotting has some limitations due to image resolution and/or printer quality.

73 Oslo og Akershus SSK 2

Oslo og Akershus SSK

Result: 13

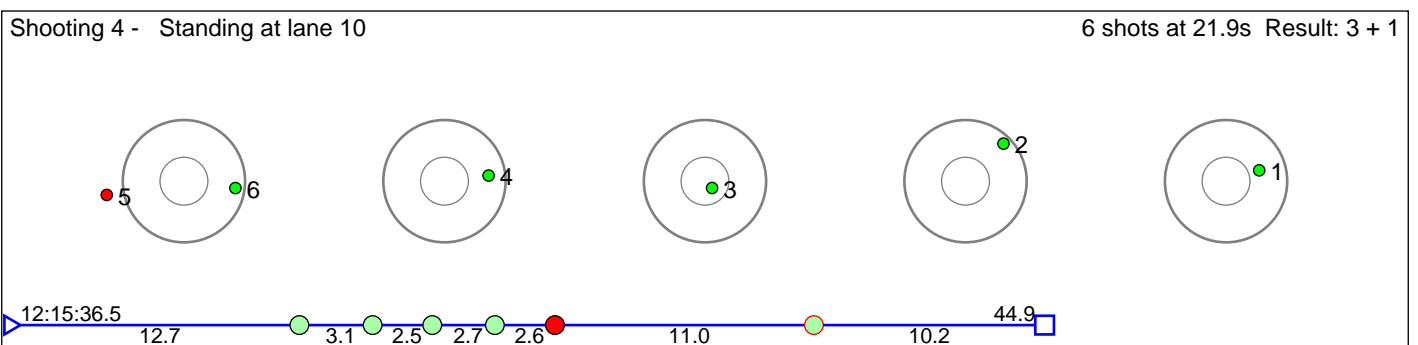
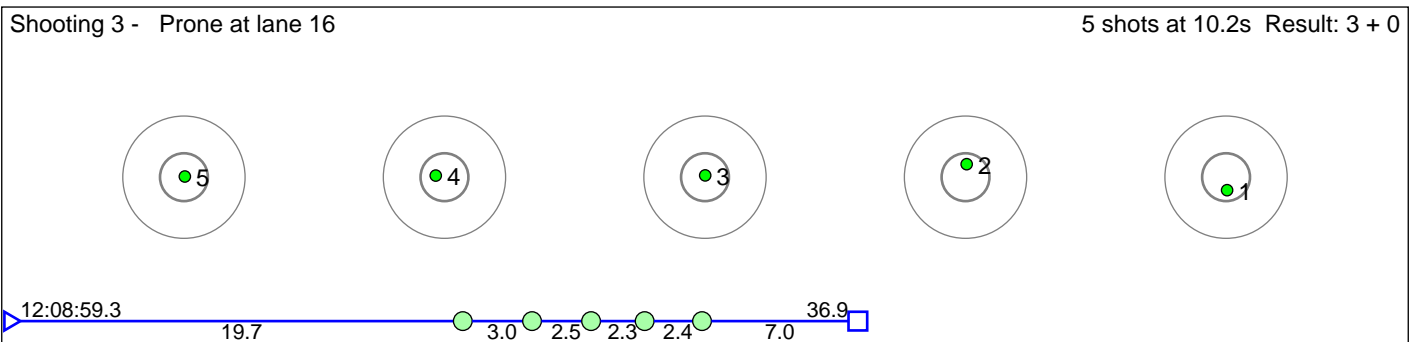
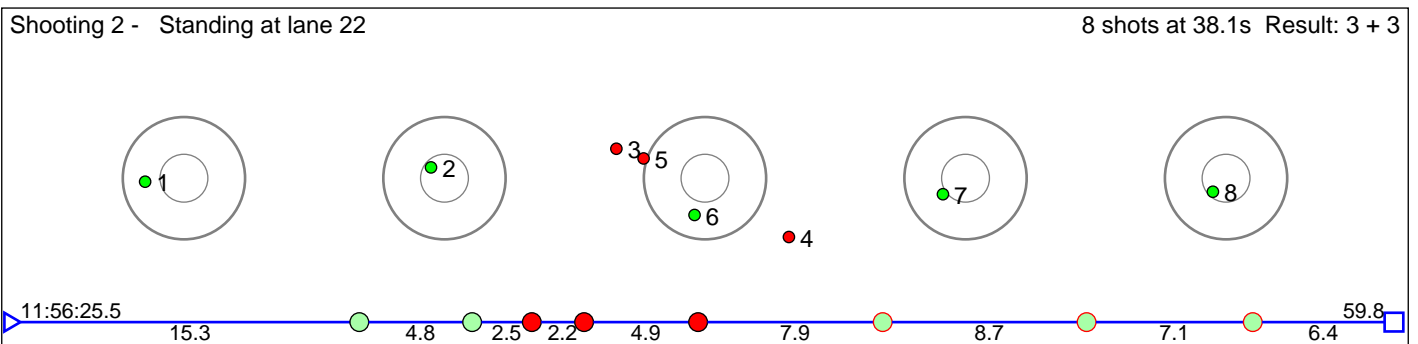
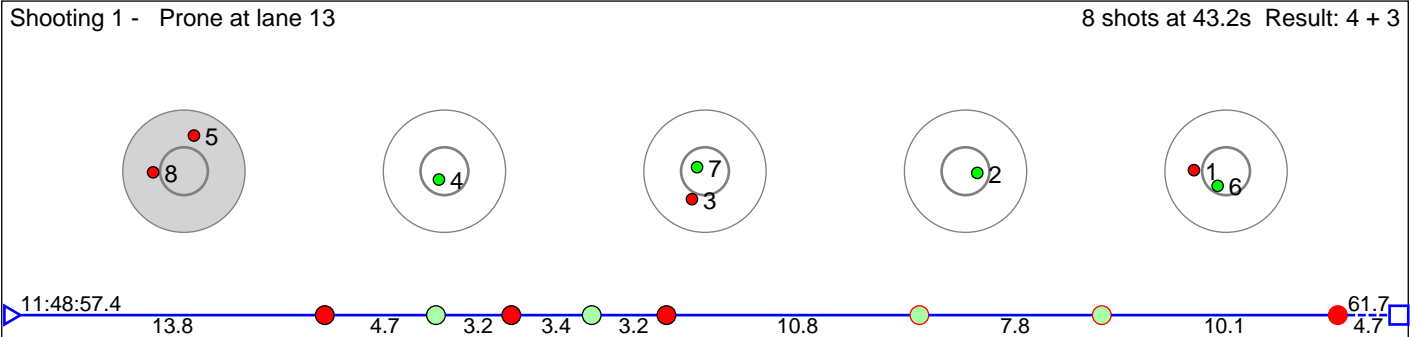

Shooting 5 - Prone at lane 7 5 shots at 8.4s Result: 0 + 0

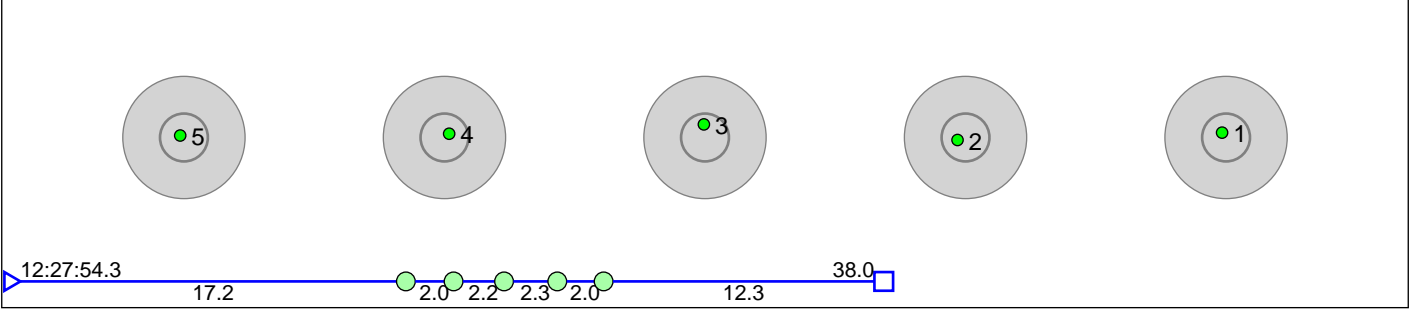

Shooting 6 - Standing at lane 5 5 shots at 9.6s Result: 0 + 0

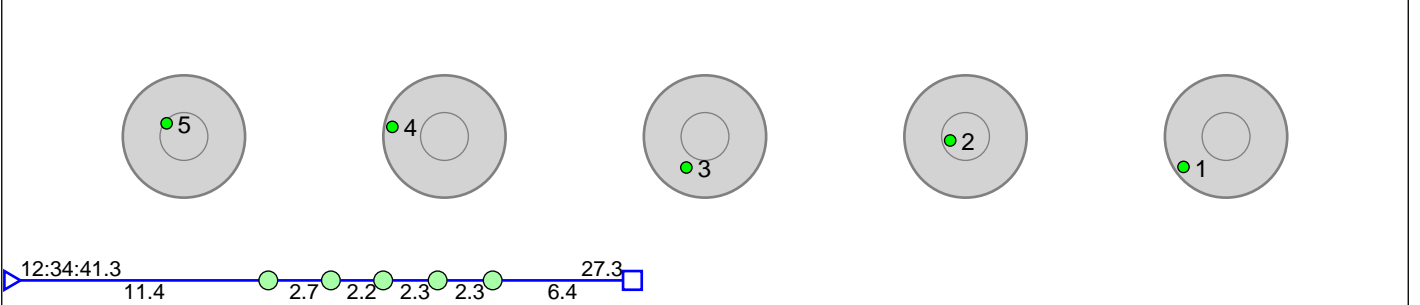

Shooting 7 - Prone at lane 5 7 shots at 32.0s Result: 0 + 2

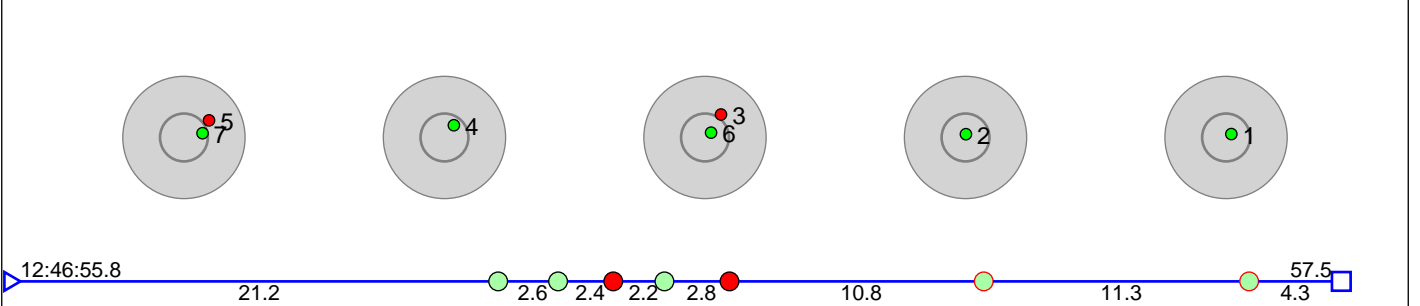

Shooting 8 - Standing at lane 5 5 shots at 7.4s Result: 0 + 0

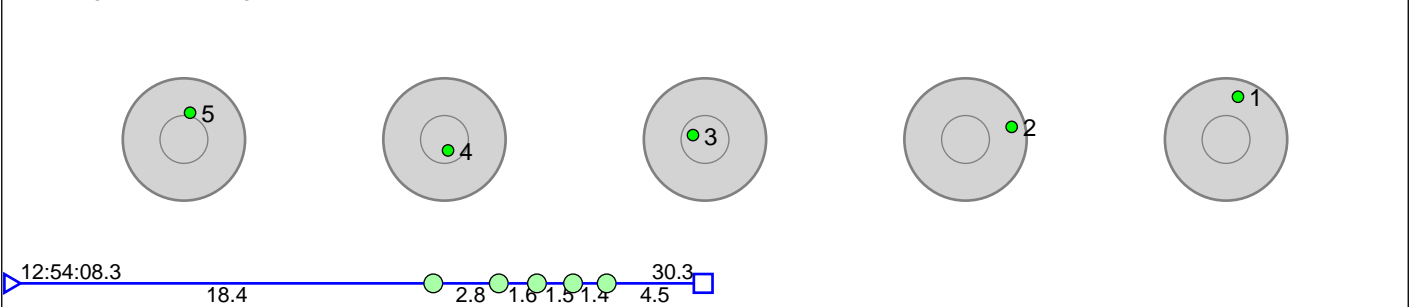

Disclaimer:

These results are unofficial since only the final output from the timing system can provide complete and correct competition results. The graphic plot of each series, presents the location of the shots on each of the five targets. Please observe that the accuracy of the plotting has some limitations due to image resolution and/or printer quality.

74 Troms SSK 2

Troms SSK

Result: 15

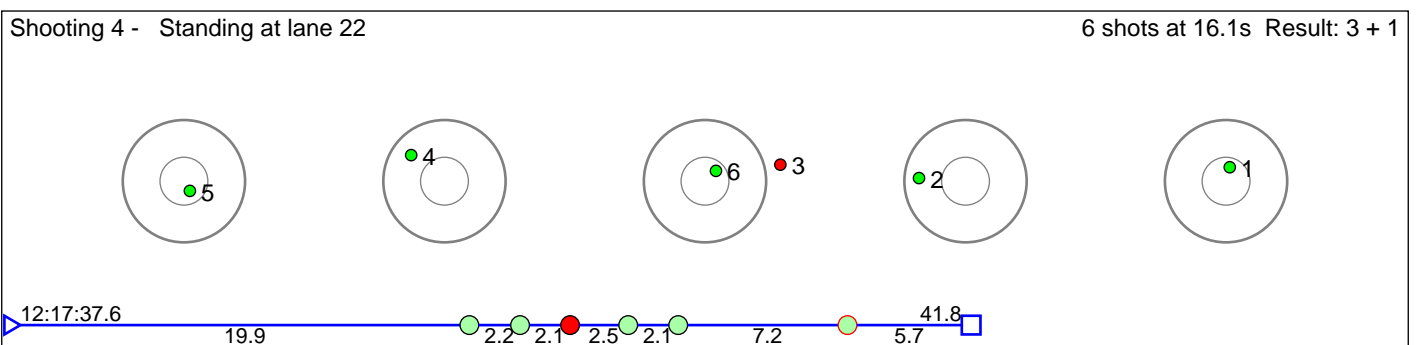
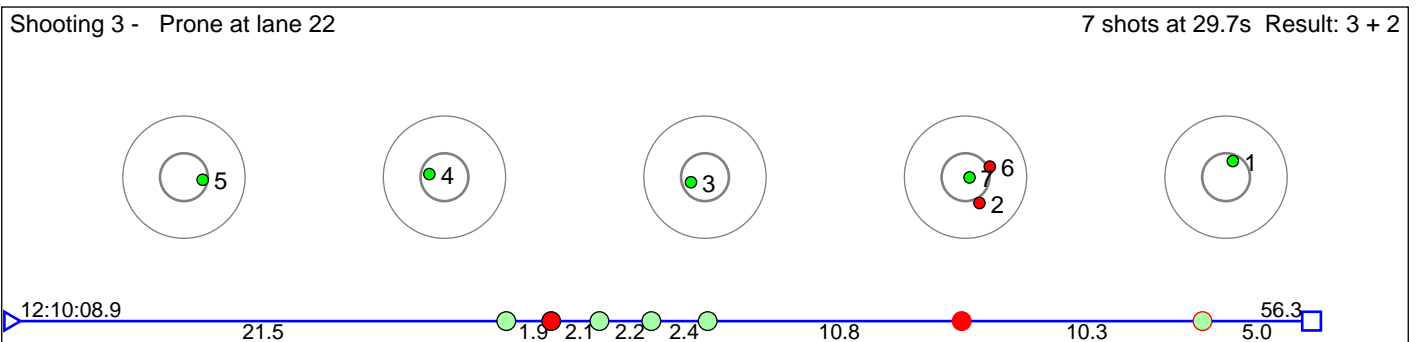
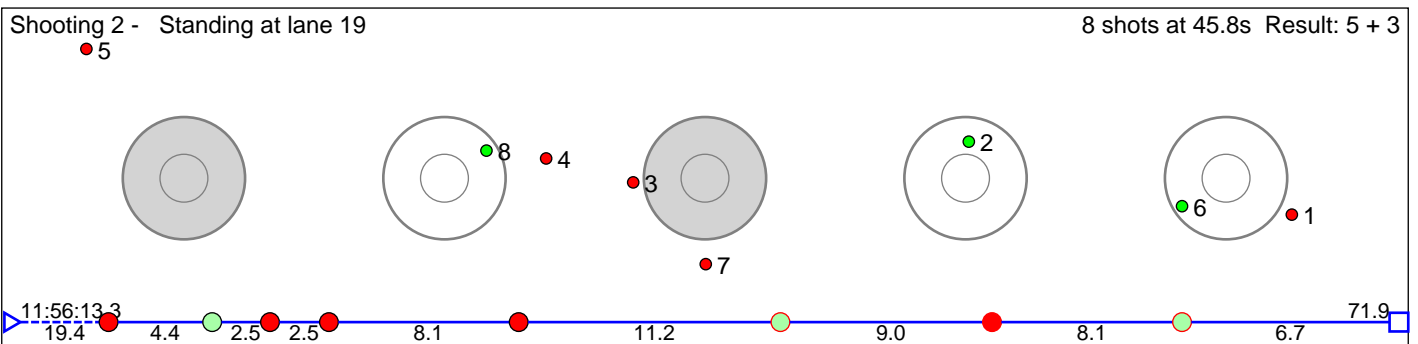
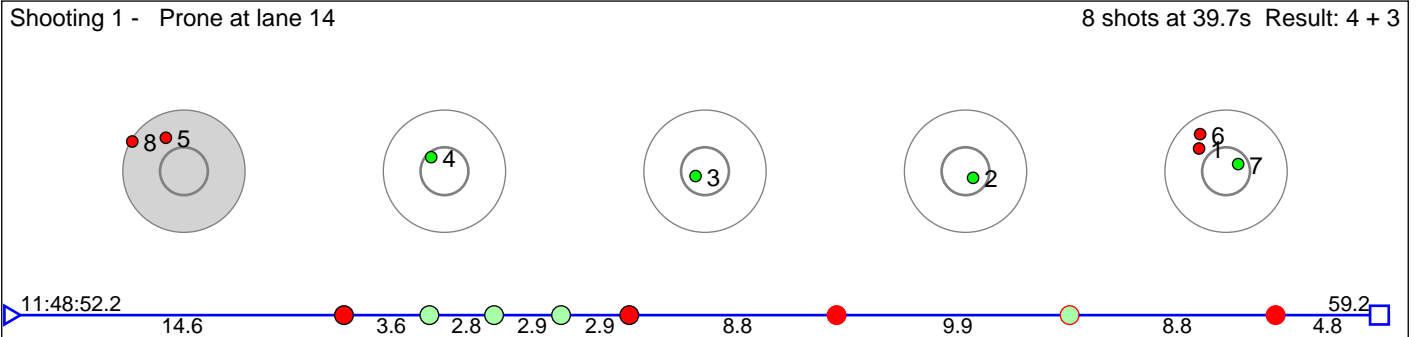

Shooting 5 - Prone at lane 21 7 shots at 28.3s Result: 0 + 2

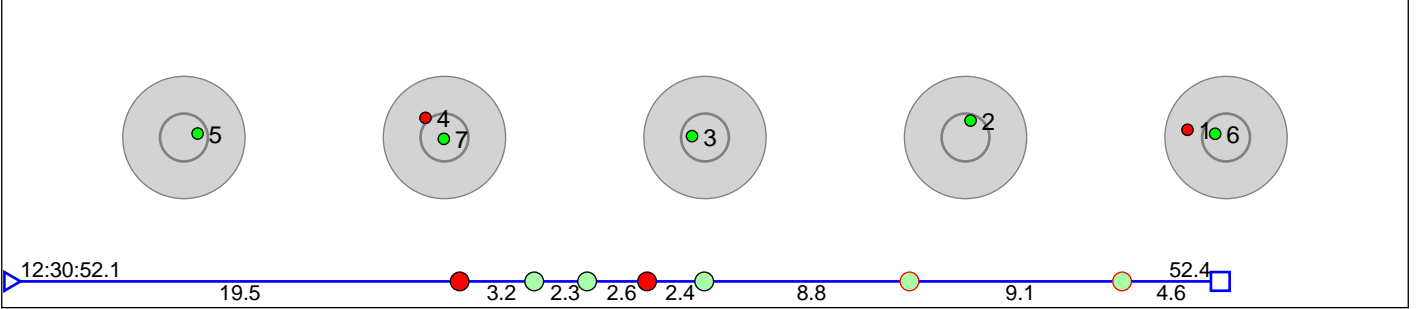

Shooting 6 - Standing at lane 21 8 shots at 29.1s Result: 0 + 3

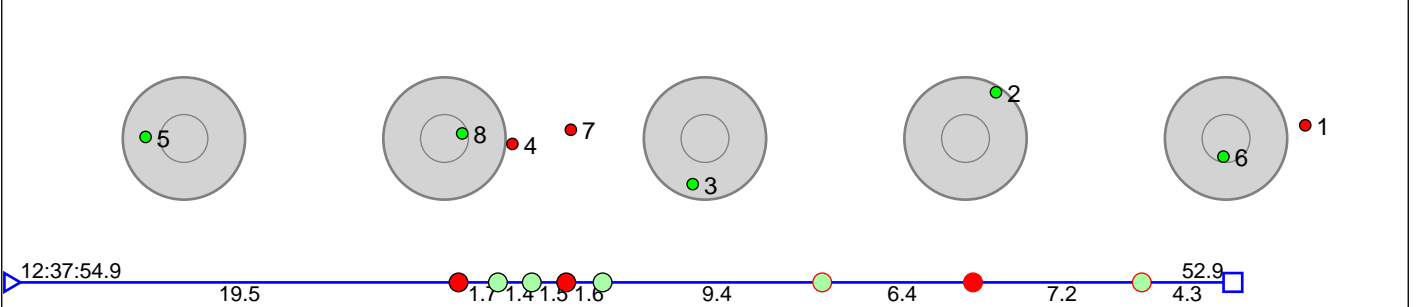

Shooting 7 - Prone at lane 21 5 shots at 9.1s Result: 0 + 0

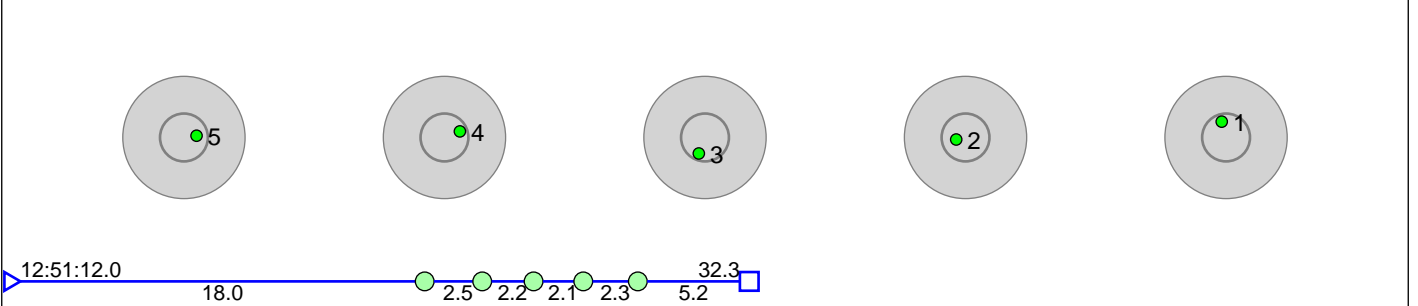

Shooting 8 - Standing at lane 21 6 shots at 16.3s Result: 0 + 1

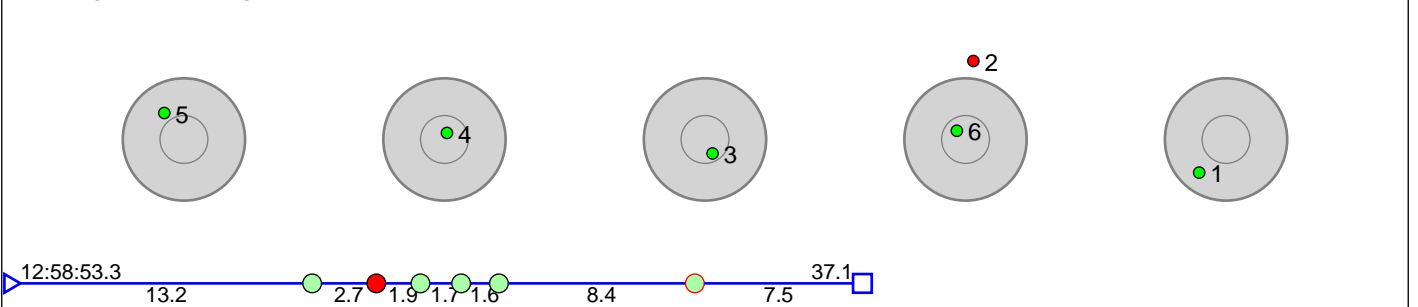

Disclaimer:

These results are unofficial since only the final output from the timing system can provide complete and correct competition results. The graphic plot of each series, presents the location of the shots on each of the five targets. Please observe that the accuracy of the plotting has some limitations due to image resolution and/or printer quality.

75 Oppland SSK 2

Oppland SSK

Result: 14

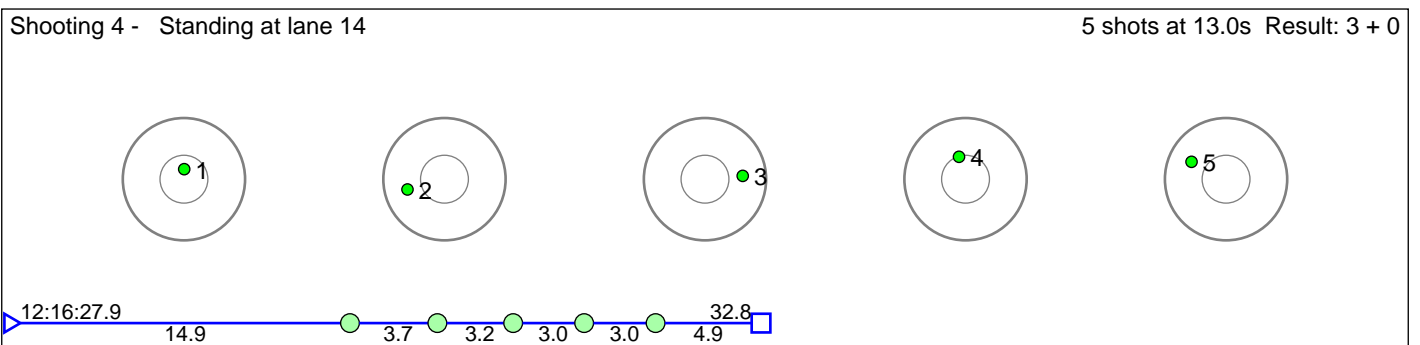
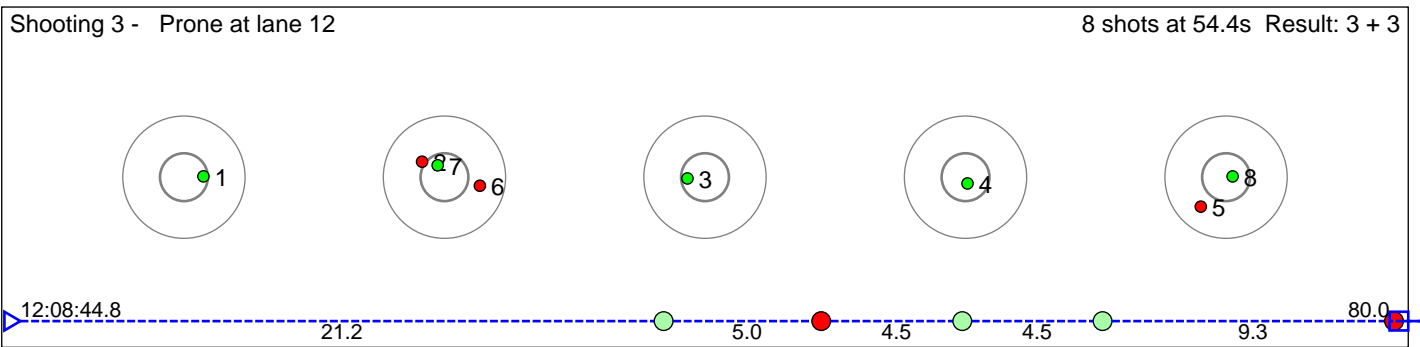
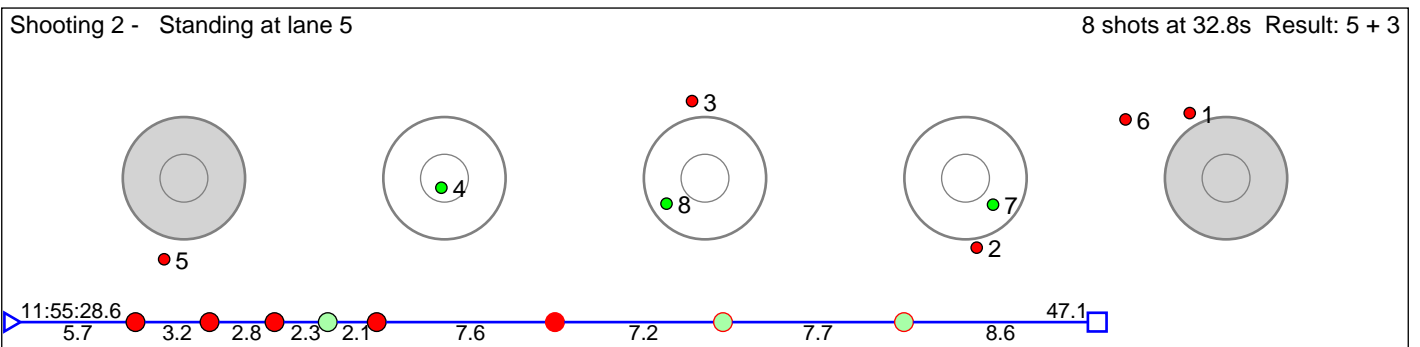
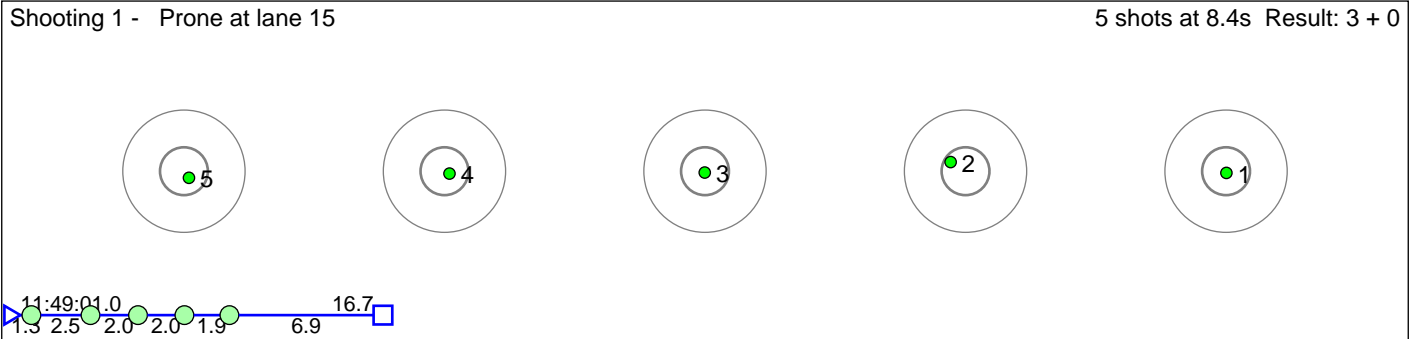

Shooting 5 - Prone at lane 11 5 shots at 9.3s Result: 0 + 0

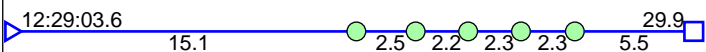
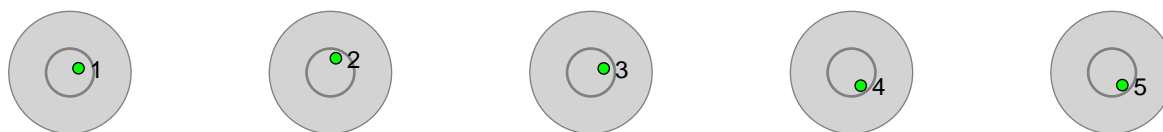

Shooting 6 - Standing at lane 10 7 shots at 21.2s Result: 0 + 2

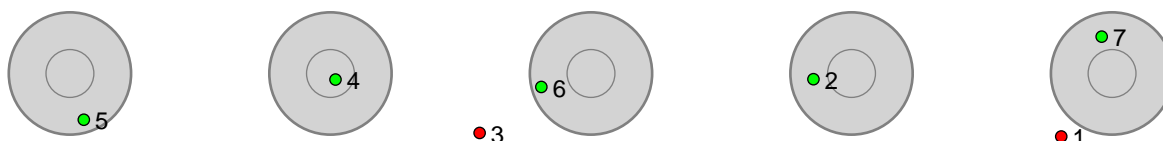

Shooting 7 - Prone at lane 9 8 shots at 35.3s Result: 0 + 3

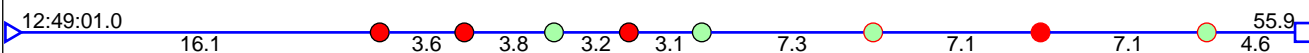
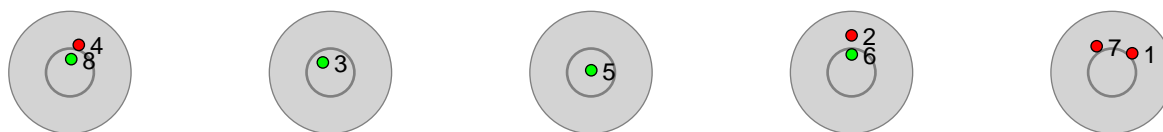

Shooting 8 - Standing at lane 12 8 shots at 32.0s Result: 0 + 3

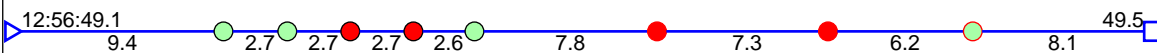
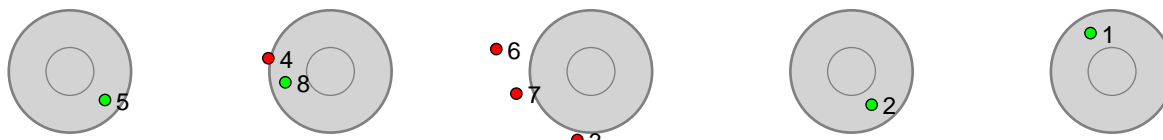

Disclaimer:

These results are unofficial since only the final output from the timing system can provide complete and correct competition results. The graphic plot of each series, presents the location of the shots on each of the five targets. Please observe that the accuracy of the plotting has some limitations due to image resolution and/or printer quality.

76 Agder og Rogaland SSK 2

Agder og Rogaland SSK

Result: 15

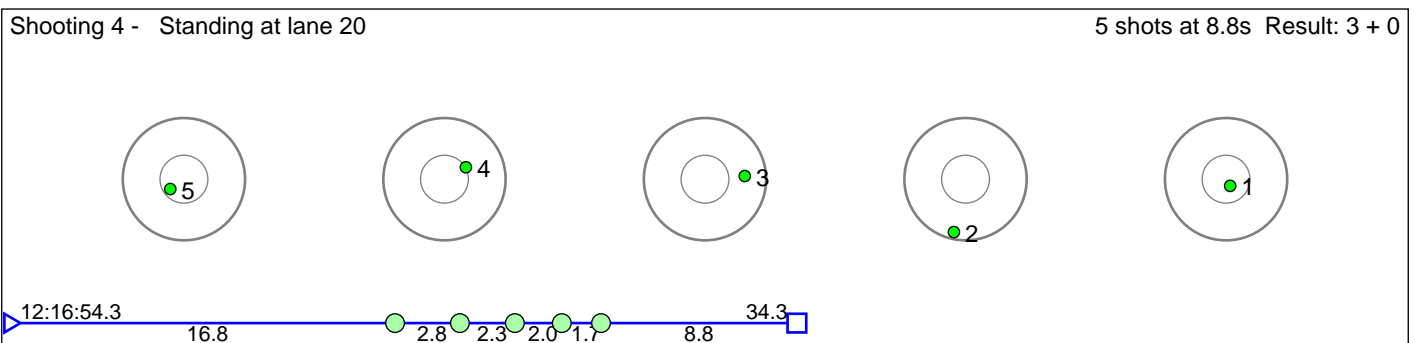
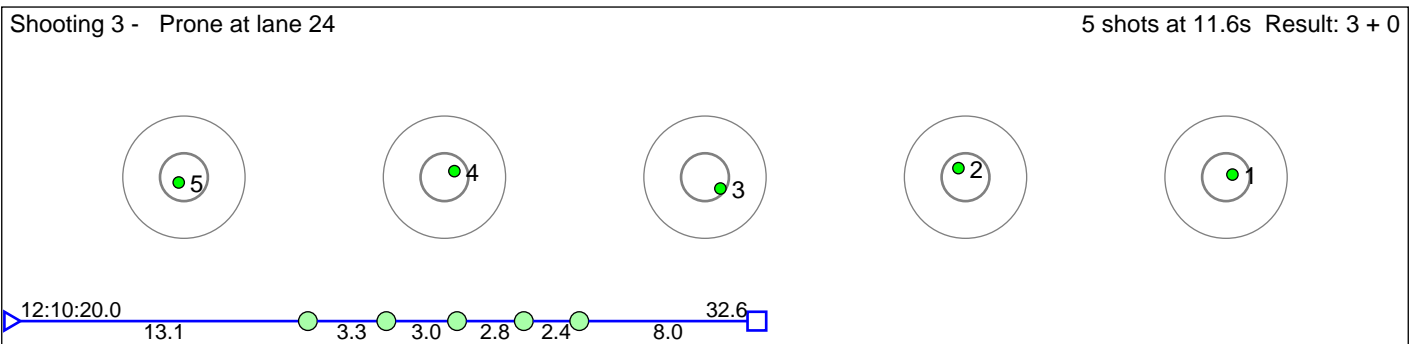
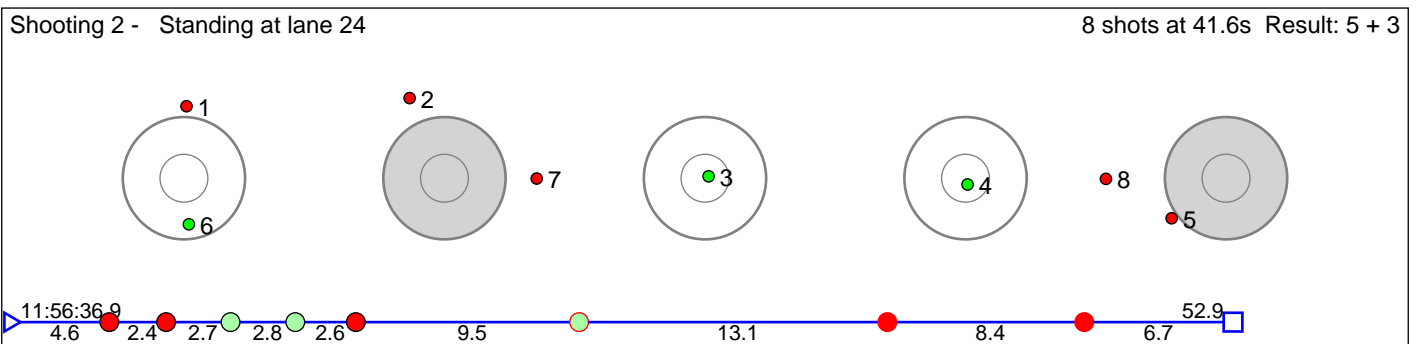
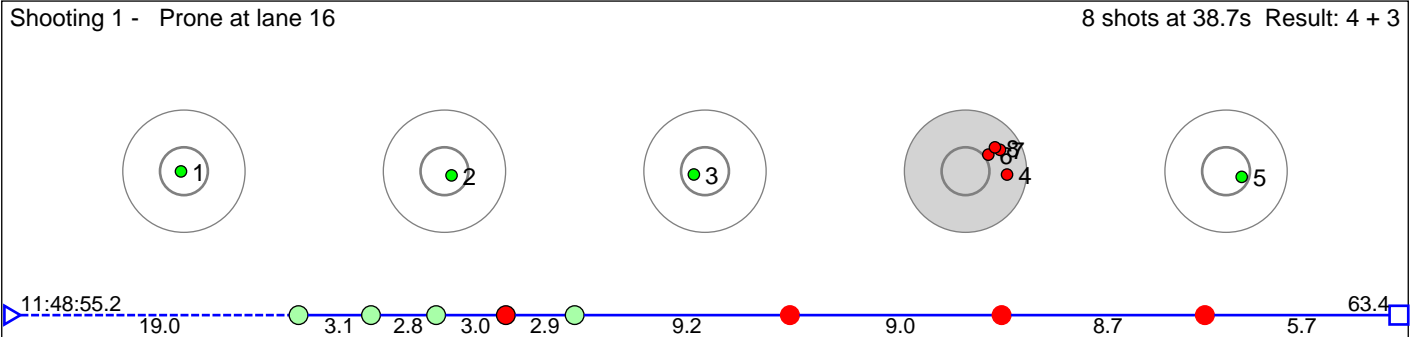

Shooting 5 - Prone at lane 19 7 shots at 28.0s Result: 0 + 2

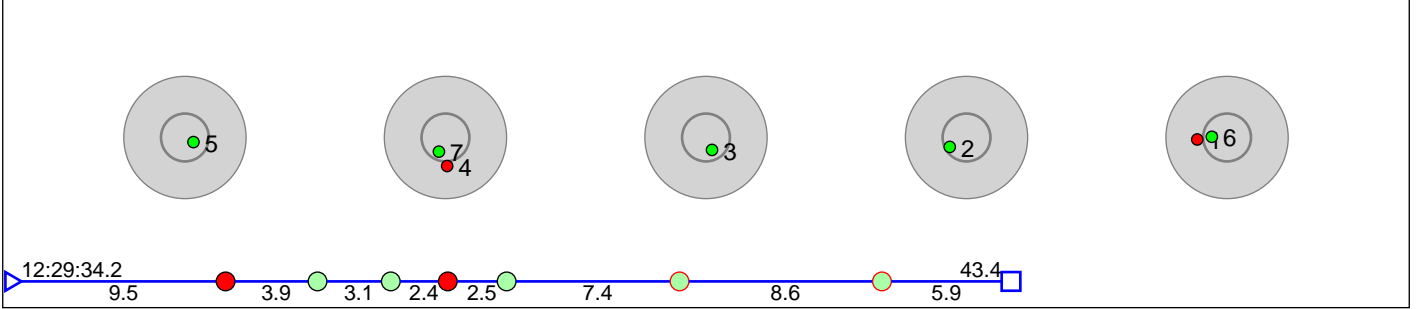

Shooting 6 - Standing at lane 15 8 shots at 37.8s Result: 0 + 3

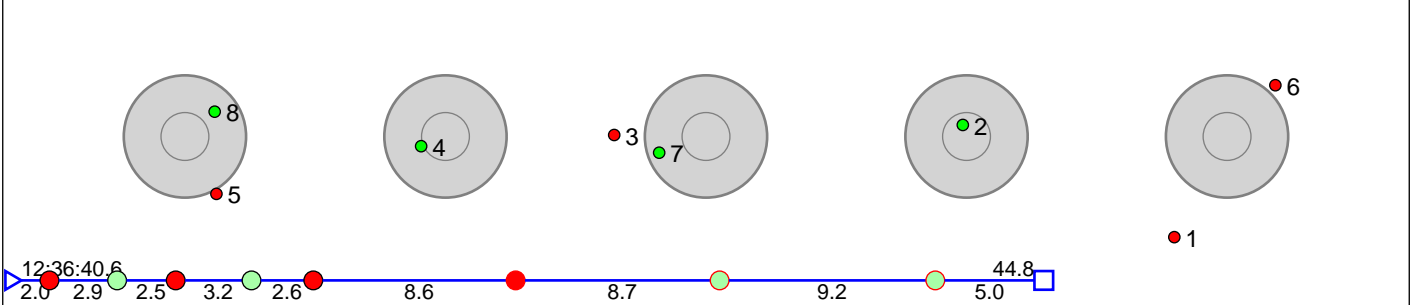

Shooting 7 - Prone at lane 19 8 shots at 55.3s Result: 0 + 3

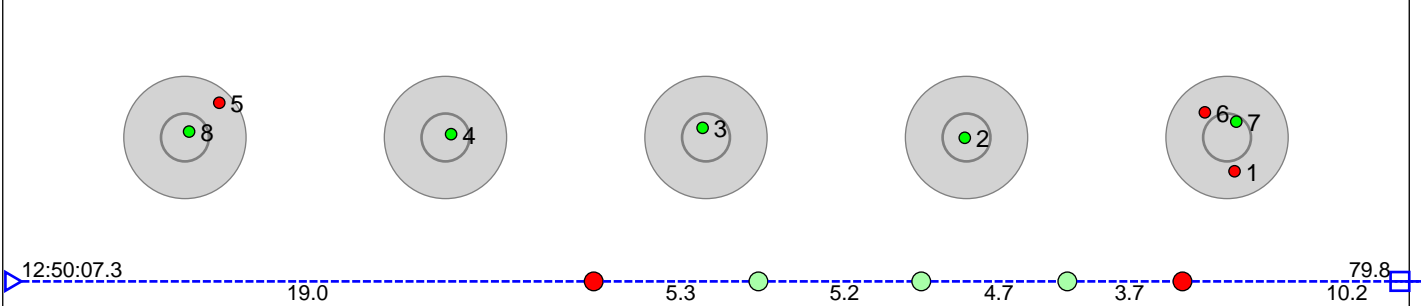

Shooting 8 - Standing at lane 18 8 shots at 48.4s Result: 0 + 3

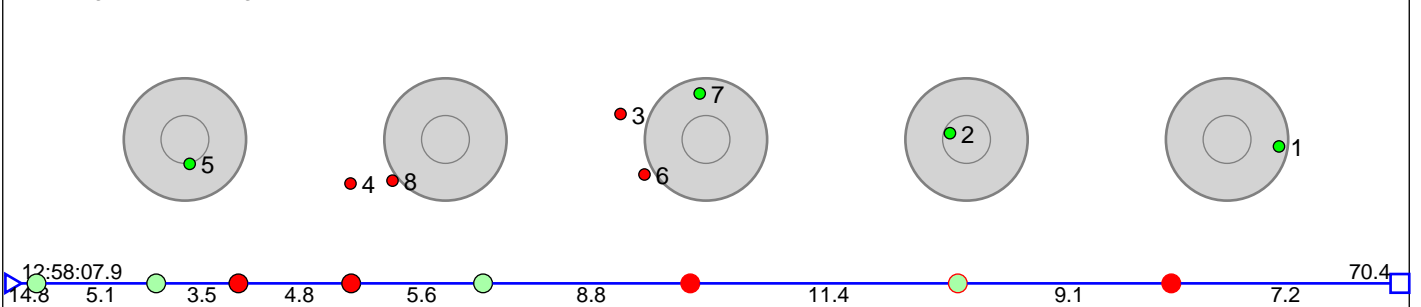

Disclaimer:

These results are unofficial since only the final output from the timing system can provide complete and correct competition results. The graphic plot of each series, presents the location of the shots on each of the five targets. Please observe that the accuracy of the plotting has some limitations due to image resolution and/or printer quality.

77 Nord-Trøndelag SSK 2

Nord-Trøndelag SSK

Result: 14

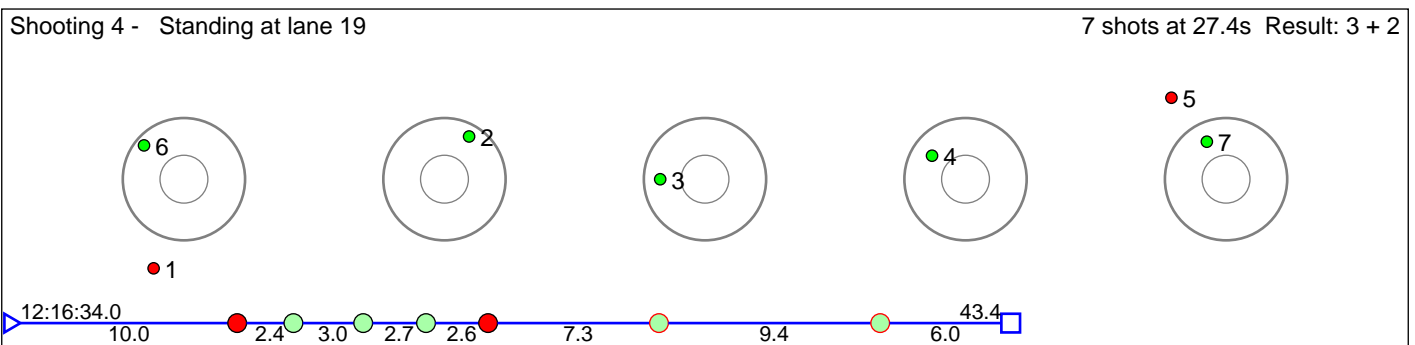
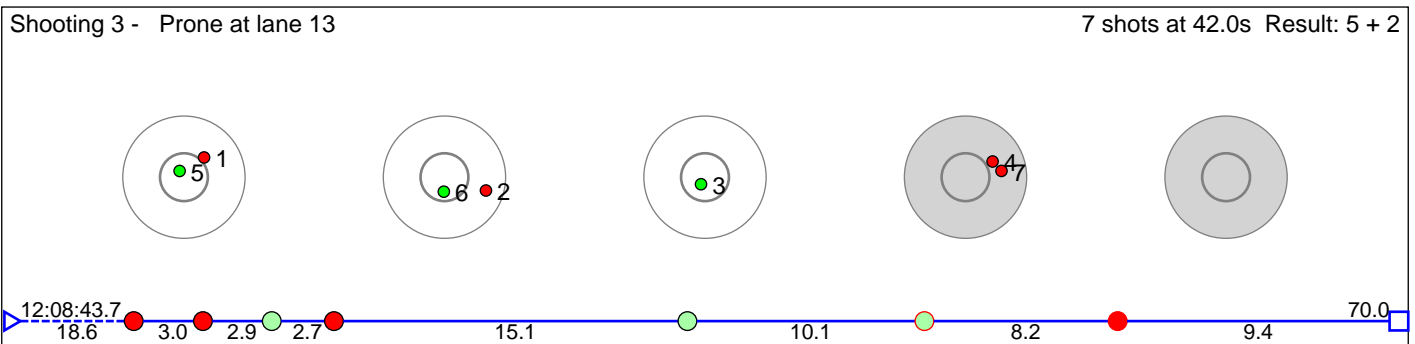
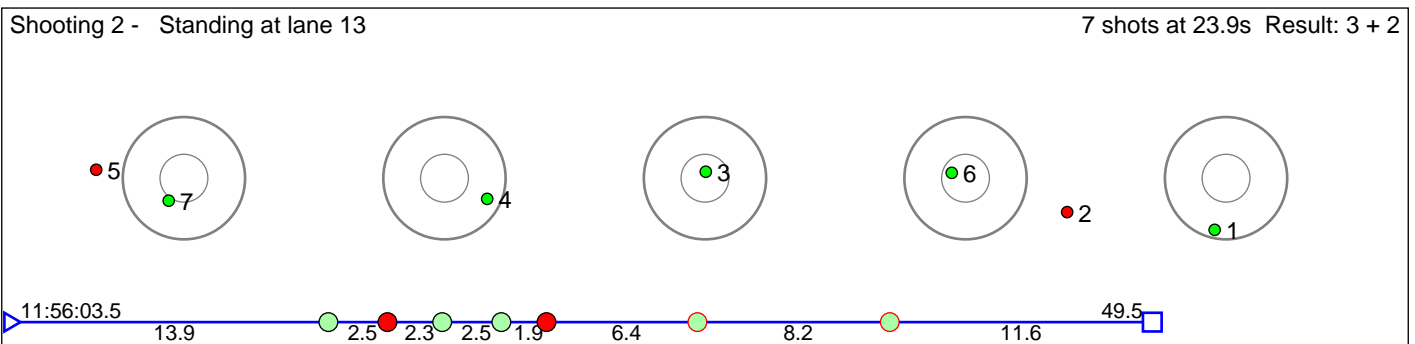
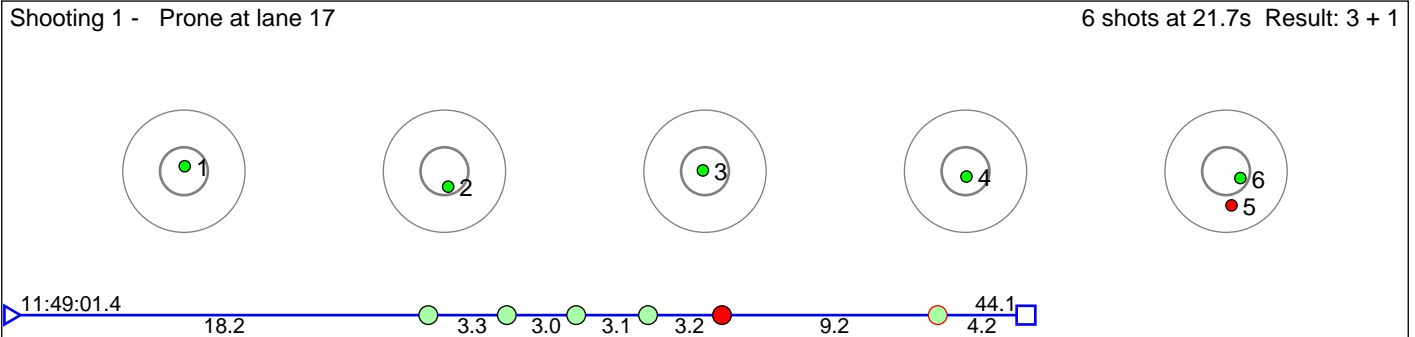

Shooting 5 - Prone at lane 12 8 shots at 43.9s Result: 0 + 3

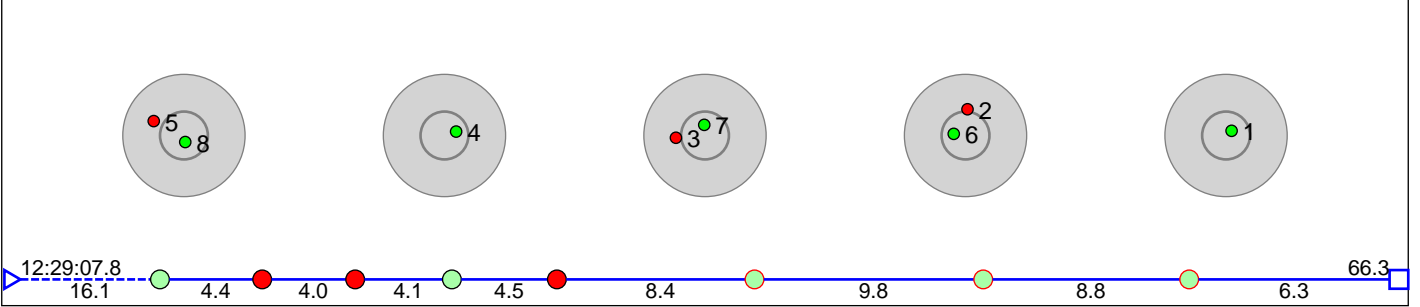

Shooting 6 - Standing at lane 12 6 shots at 17.1s Result: 0 + 1

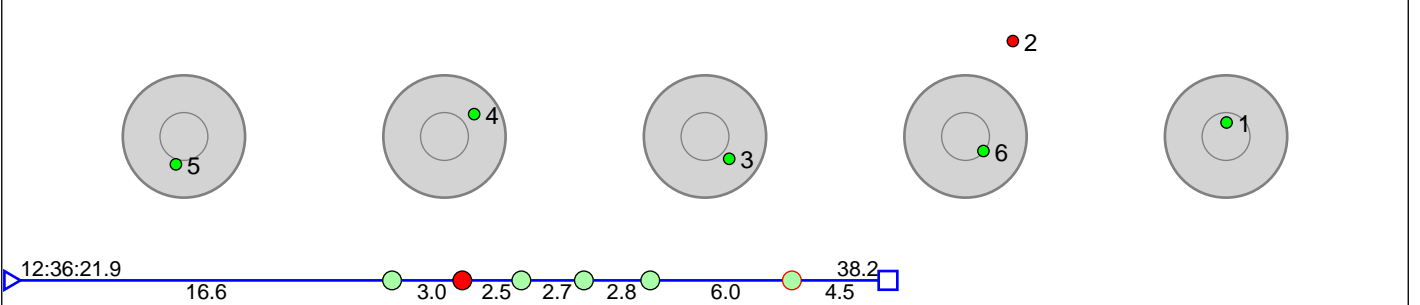

Shooting 7 - Prone at lane 14 8 shots at 55.5s Result: 0 + 3

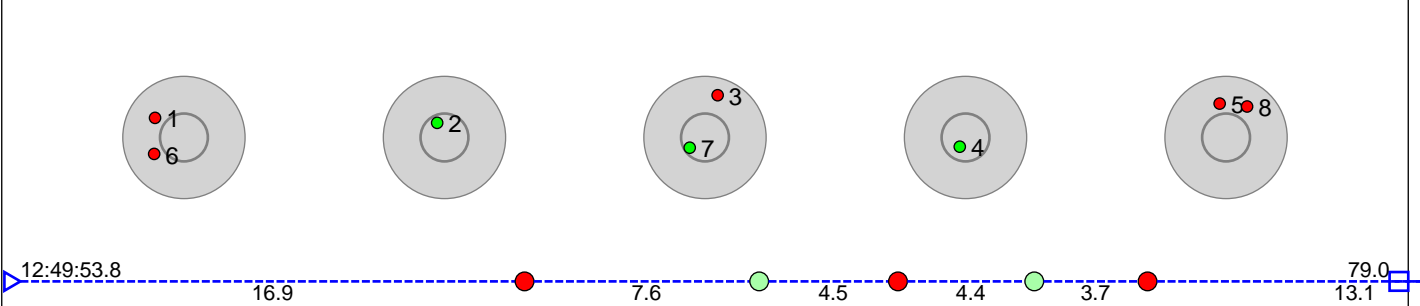

Shooting 8 - Standing at lane 20 8 shots at 44.2s Result: 0 + 3

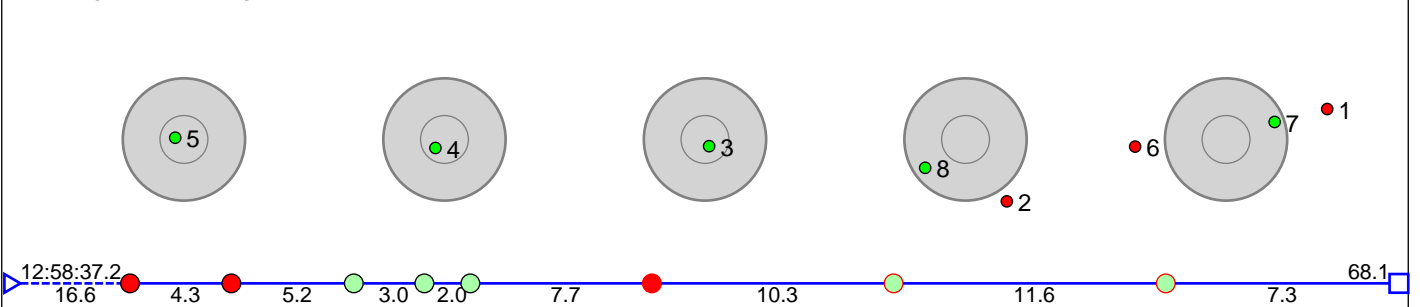

Disclaimer:

These results are unofficial since only the final output from the timing system can provide complete and correct competition results. The graphic plot of each series, presents the location of the shots on each of the five targets. Please observe that the accuracy of the plotting has some limitations due to image resolution and/or printer quality.

78 Sør-Trøndelag SSK 2

Sør-Trøndelag SSK

Result: 13

Shooting 1 - Prone at lane 18

5 shots at 8.5s Result: 3 + 0

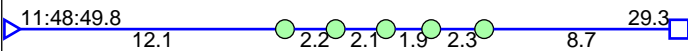
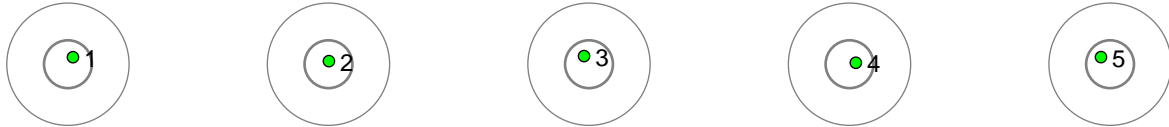

Shooting 2 - Standing at lane 14

6 shots at 17.0s Result: 3 + 1

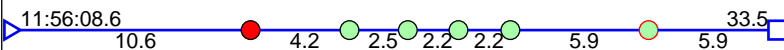
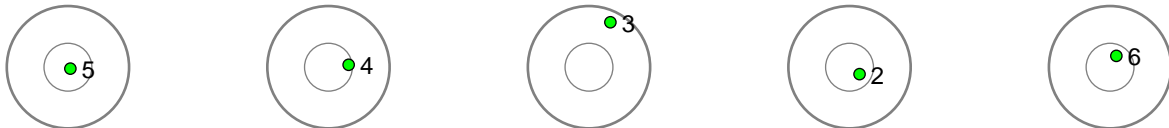

Shooting 3 - Prone at lane 15

8 shots at 39.2s Result: 4 + 3

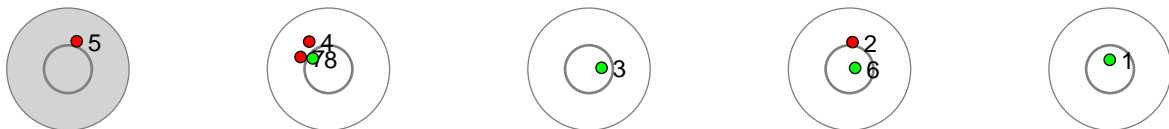

Shooting 4 - Standing at lane 15

8 shots at 37.0s Result: 3 + 3

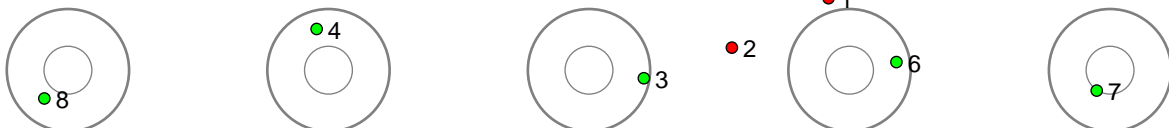

Shooting 5 - Prone at lane 18 6 shots at 32.3s Result: 0 + 1

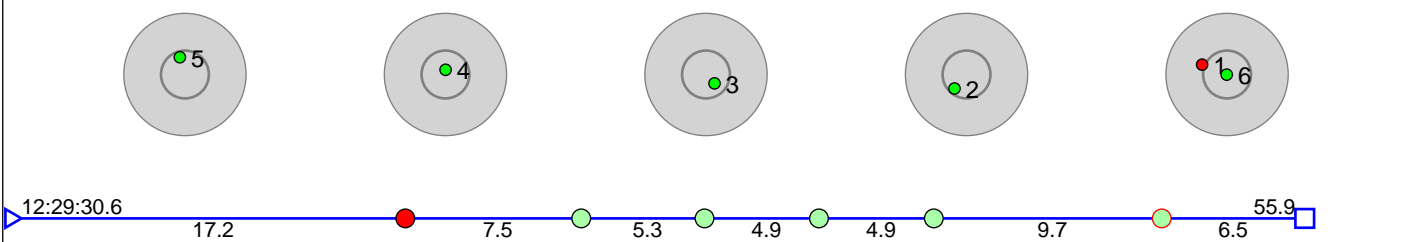

Shooting 6 - Standing at lane 18 6 shots at 26.0s Result: 0 + 1

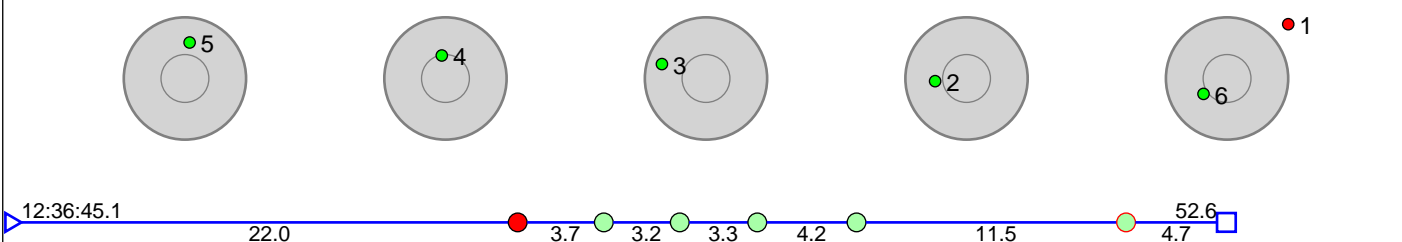

Shooting 7 - Prone at lane 17 8 shots at 48.6s Result: 0 + 3

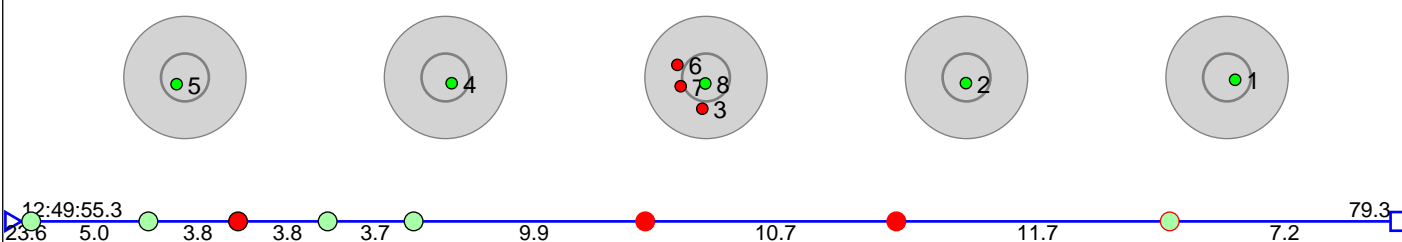

Shooting 8 - Standing at lane 17 8 shots at 49.5s Result: 0 + 3

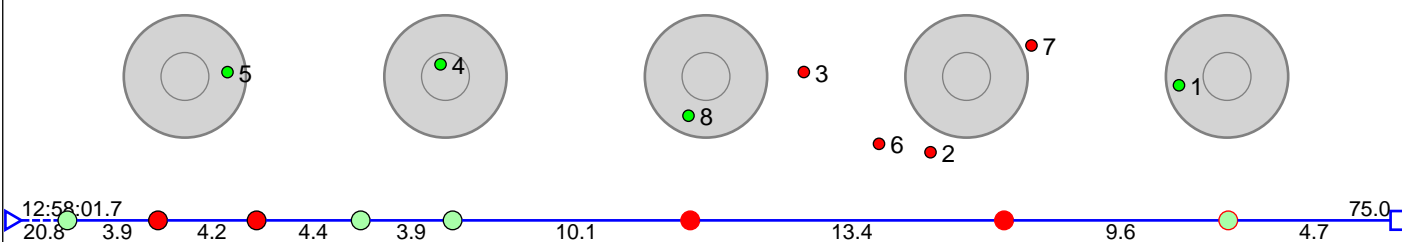

Disclaimer:

These results are unofficial since only the final output from the timing system can provide complete and correct competition results. The graphic plot of each series, presents the location of the shots on each of the five targets. Please observe that the accuracy of the plotting has some limitations due to image resolution and/or printer quality.

79 Buskerud SSK 2

Buskerud SSK

Result: 13

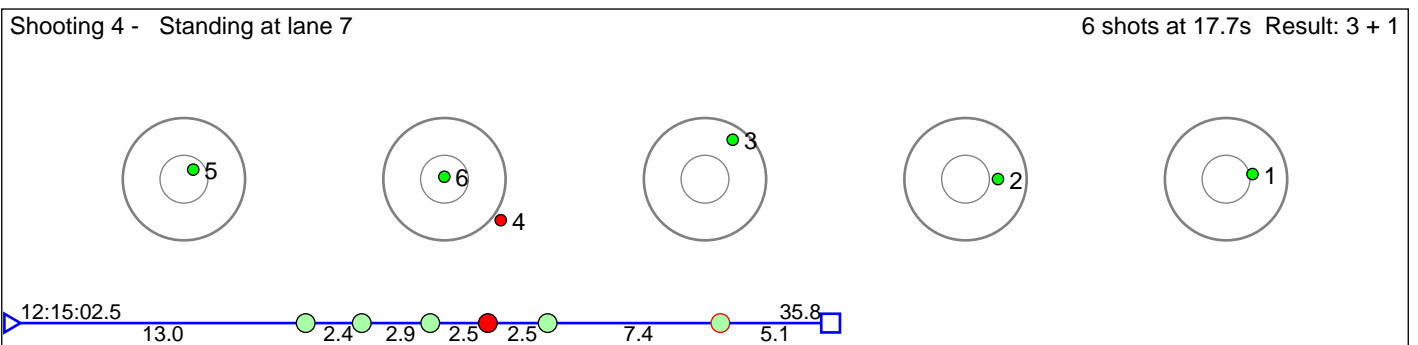
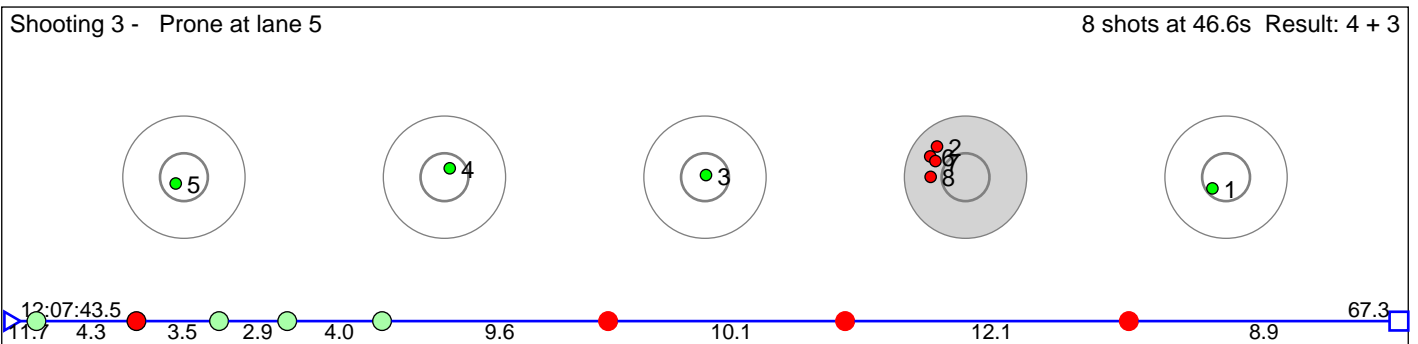
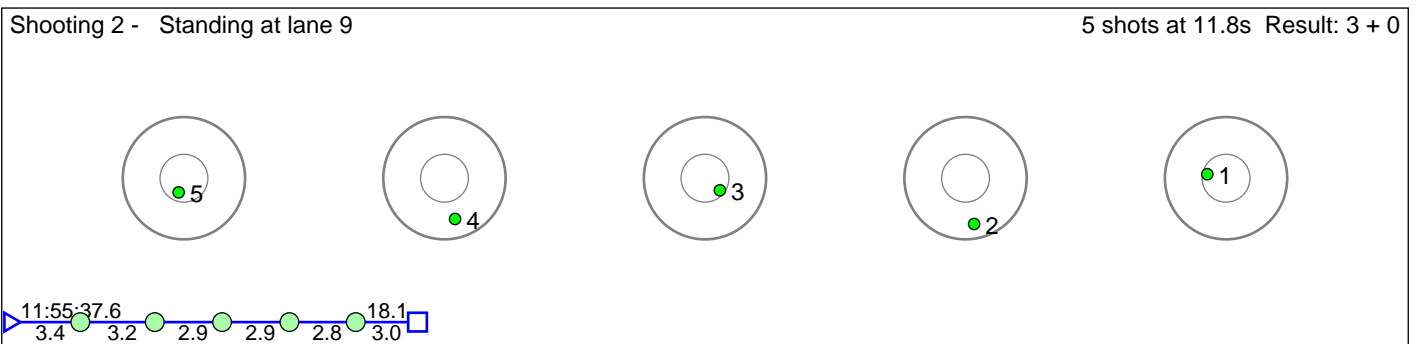
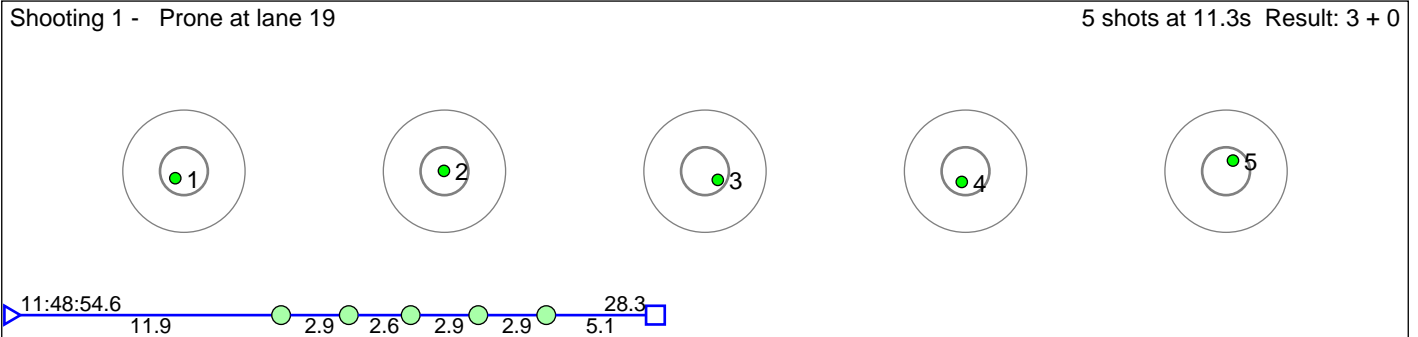

Shooting 5 - Prone at lane 3 8 shots at 50.8s Result: 0 + 3

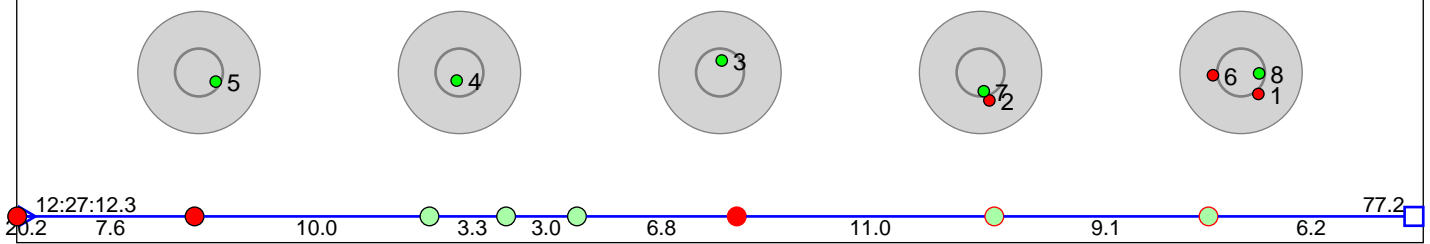

Shooting 6 - Standing at lane 3 7 shots at 29.1s Result: 0 + 2

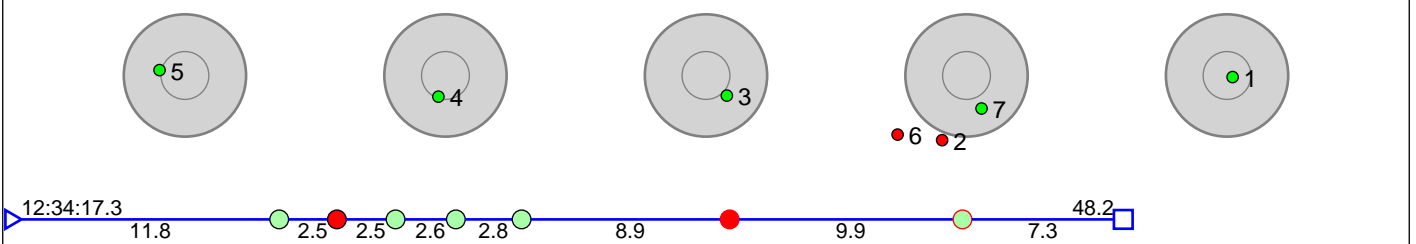

Shooting 7 - Prone at lane 4 6 shots at 21.7s Result: 0 + 1

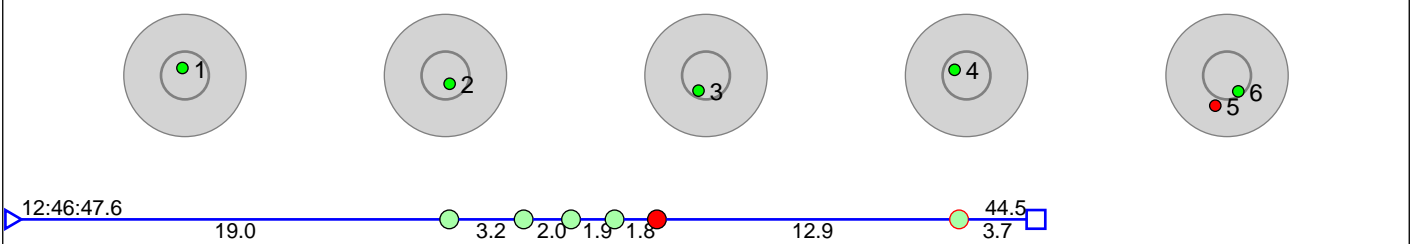

Shooting 8 - Standing at lane 4 5 shots at 5.9s Result: 0 + 0

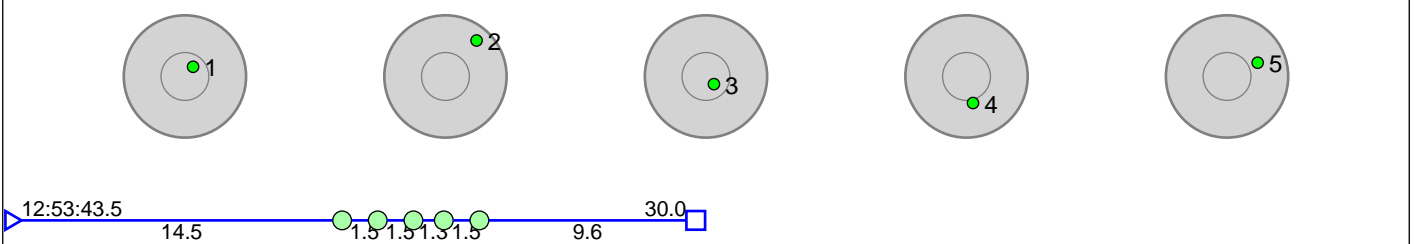

Disclaimer:

These results are unofficial since only the final output from the timing system can provide complete and correct competition results. The graphic plot of each series, presents the location of the shots on each of the five targets. Please observe that the accuracy of the plotting has some limitations due to image resolution and/or printer quality.

80 Oslo og Akershus SSK 3

Oslo og Akershus SSK

Result: 12

Shooting 1 - Prone at lane 20

5 shots at 11.0s Result: 3 + 0

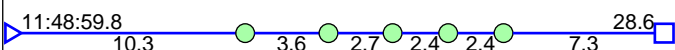
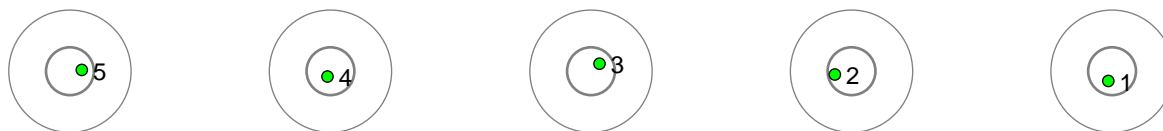

Shooting 2 - Standing at lane 4

7 shots at 28.2s Result: 3 + 2

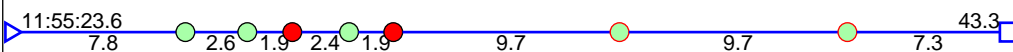
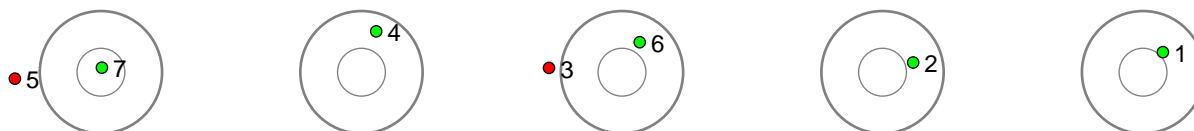

Shooting 3 - Prone at lane 8

5 shots at 10.0s Result: 3 + 0

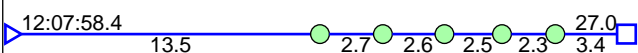
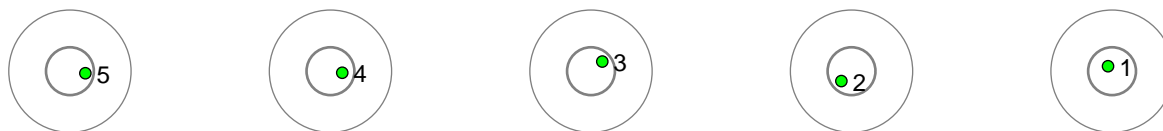

Shooting 4 - Standing at lane 6

5 shots at 12.8s Result: 3 + 0

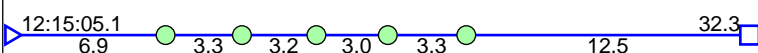
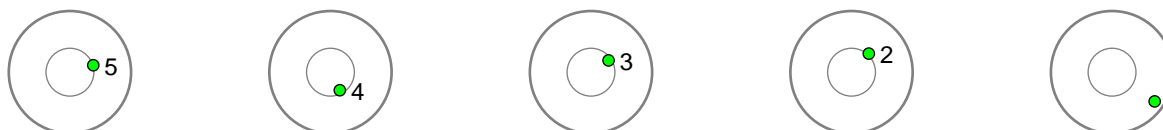

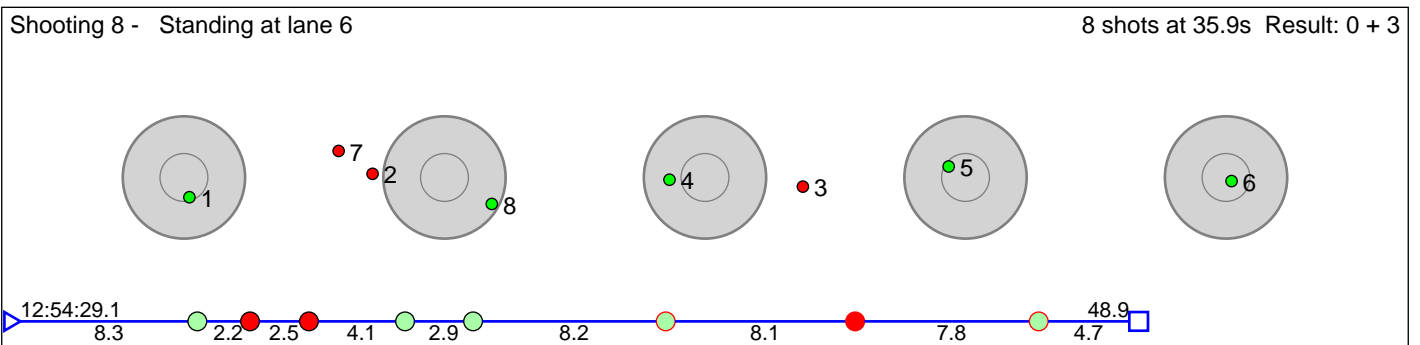
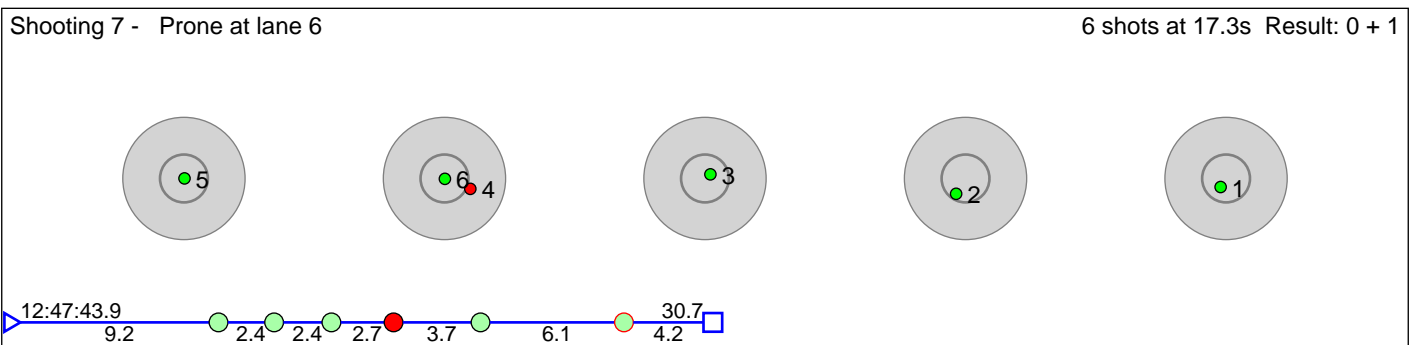
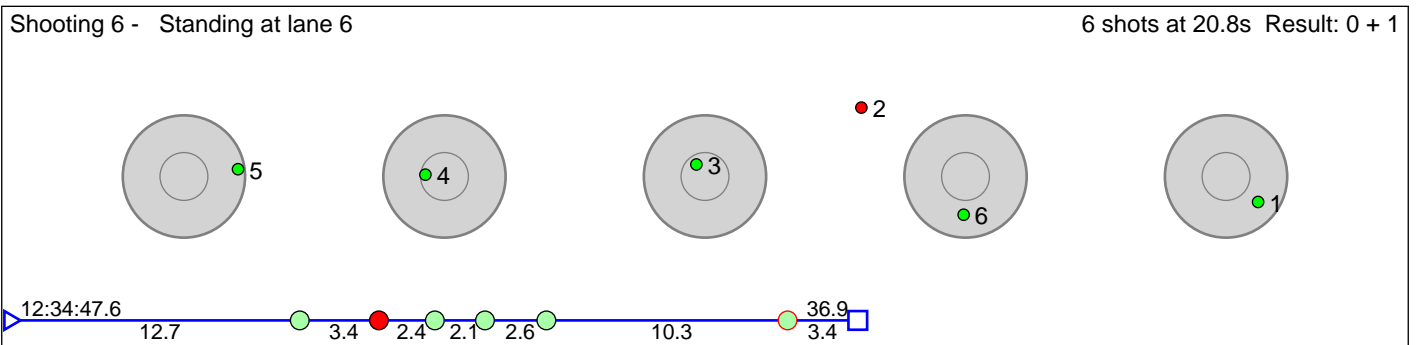
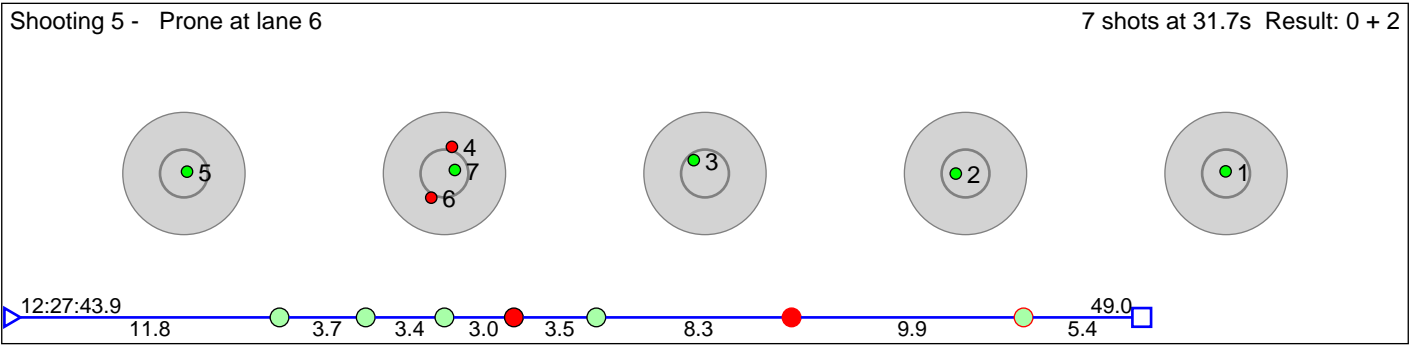

Disclaimer:

These results are unofficial since only the final output from the timing system can provide complete and correct competition results. The graphic plot of each series, presents the location of the shots on each of the five targets. Please observe that the accuracy of the plotting has some limitations due to image resolution and/or printer quality.

81 Nord-Trøndelag SSK 3

Nord-Trøndelag SSK

Result: 22

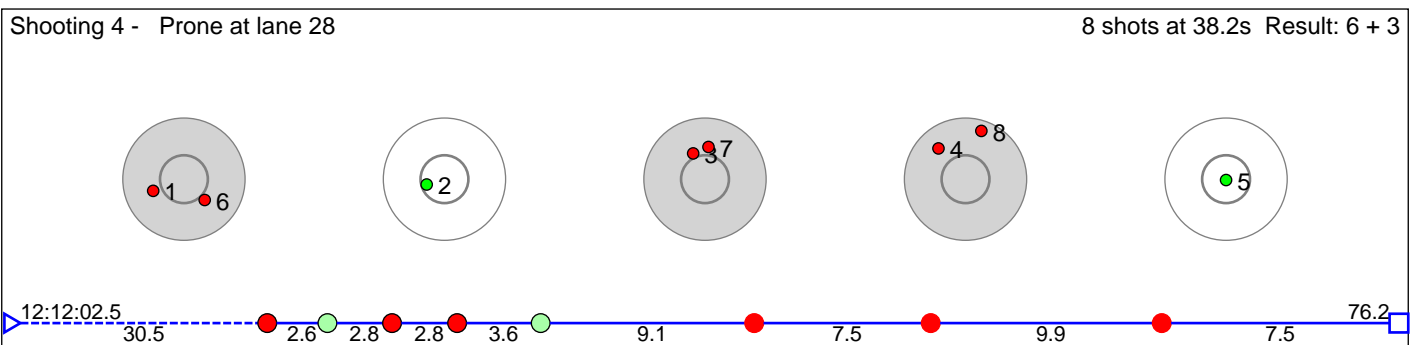
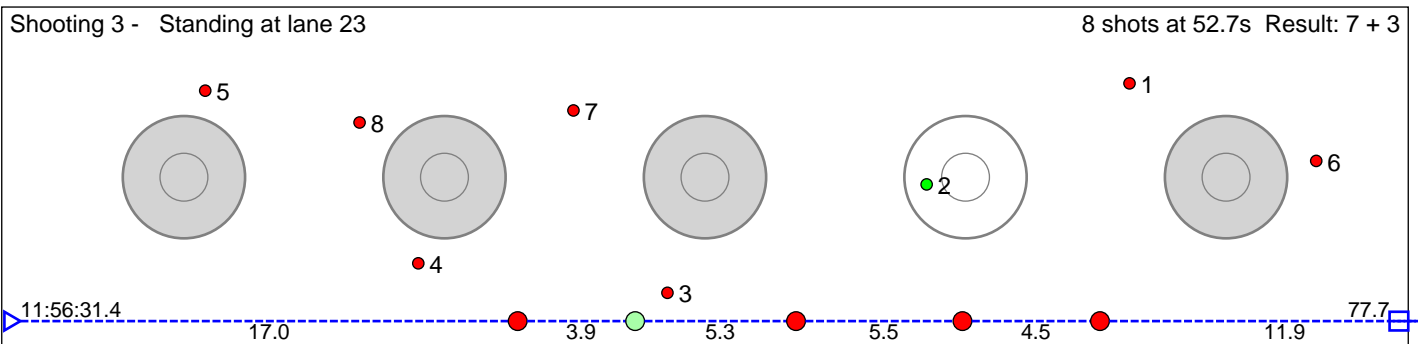
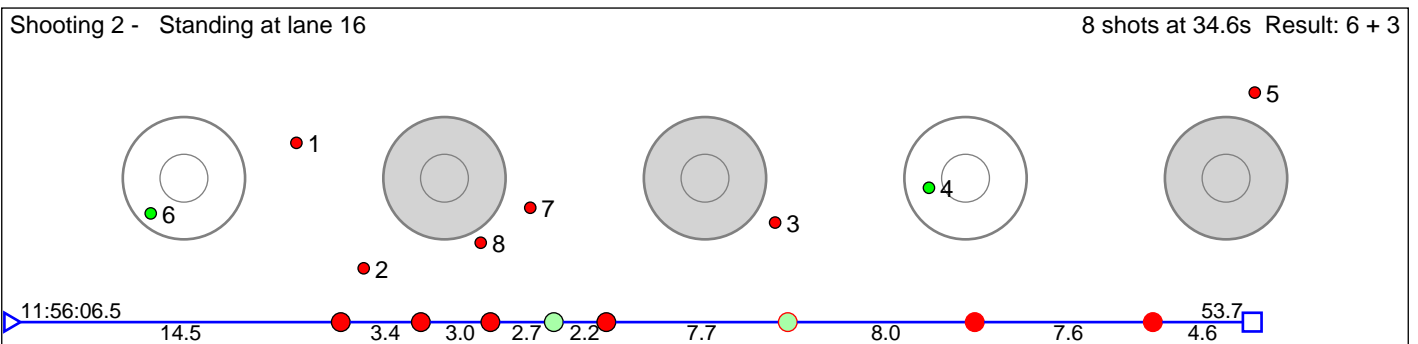
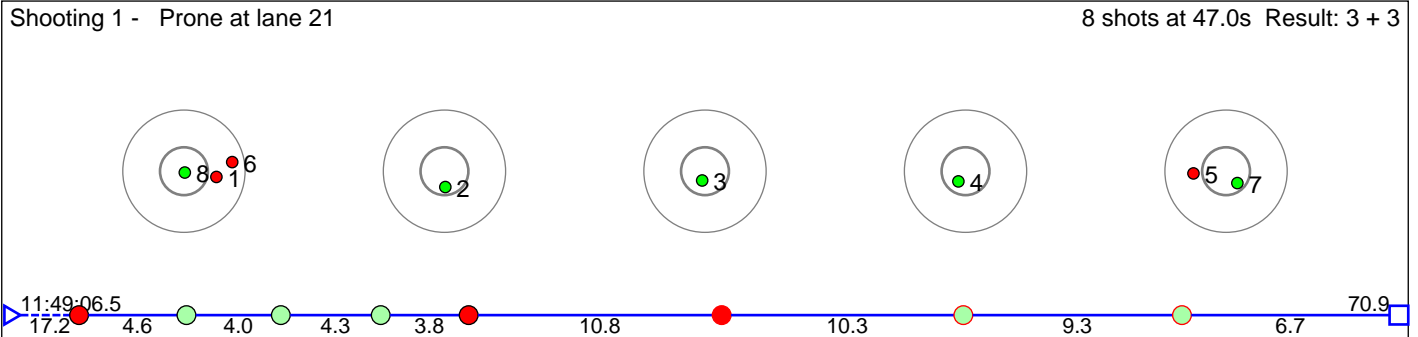

Shooting 5 - Standing at lane 29 8 shots at 46.0s Result: 0 + 3

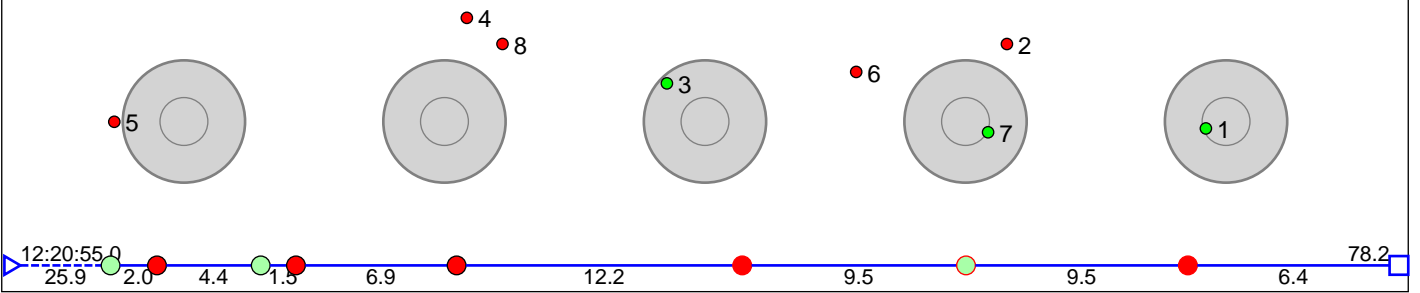

Shooting 6 - Prone at lane 29 6 shots at 23.5s Result: 0 + 1

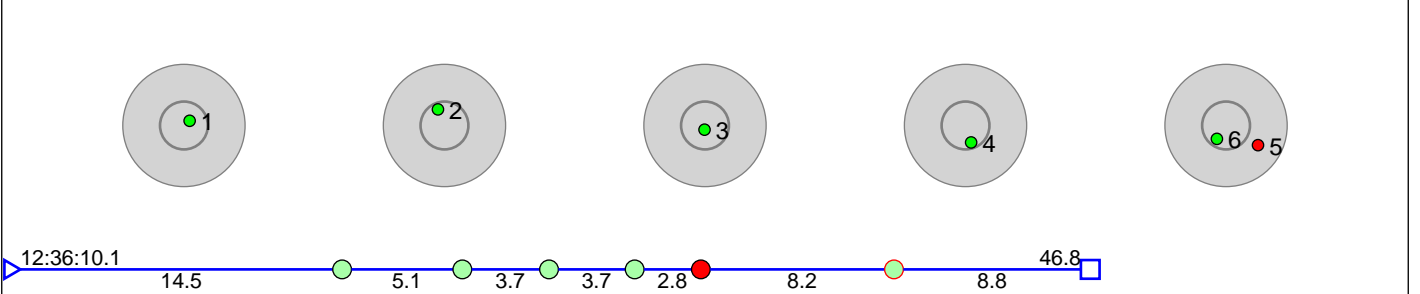

Shooting 7 - Standing at lane 27 8 shots at 32.6s Result: 0 + 3

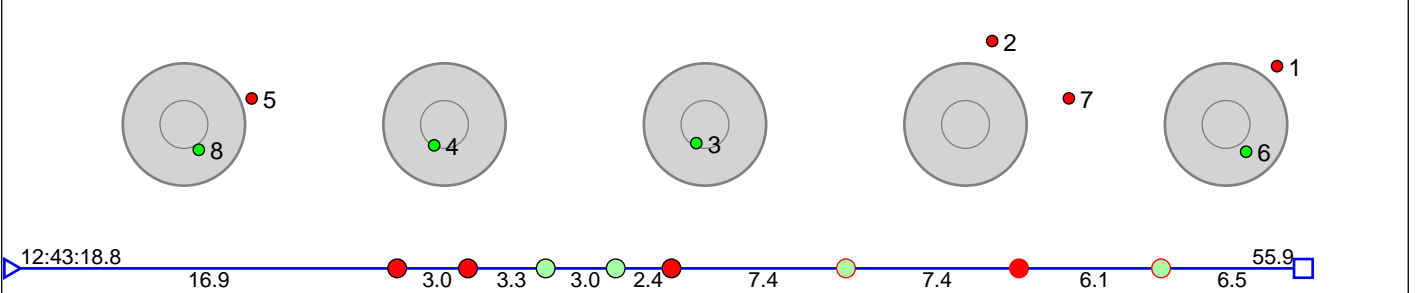

Shooting 8 - Prone at lane 26 8 shots at 50.9s Result: 0 + 3

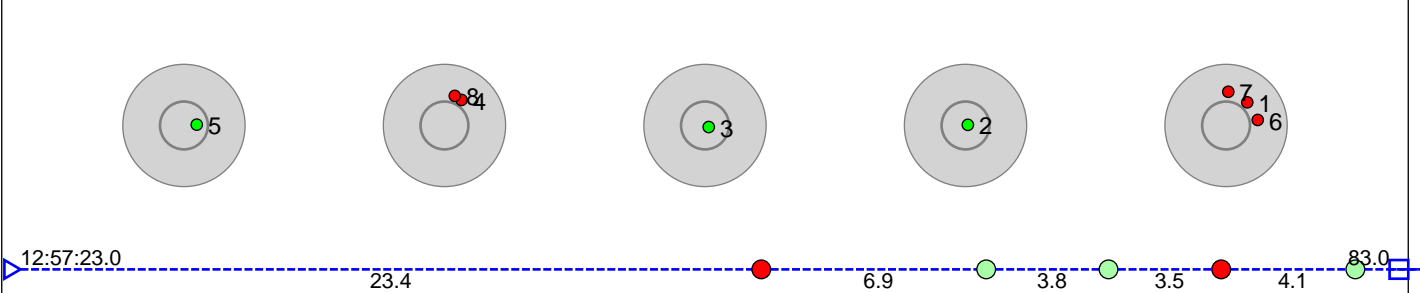

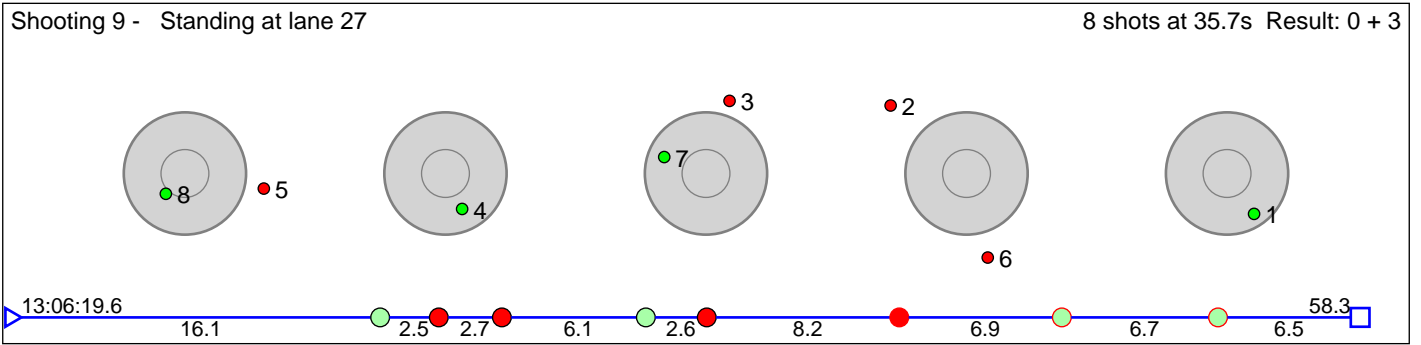

Disclaimer:

These results are unofficial since only the final output from the timing system can provide complete and correct competition results. The graphic plot of each series, presents the location of the shots on each of the five targets. Please observe that the accuracy of the plotting has some limitations due to image resolution and/or printer quality.

82 Agder og Rogaland SSK 3

Agder og Rogaland SSK

Result: 17

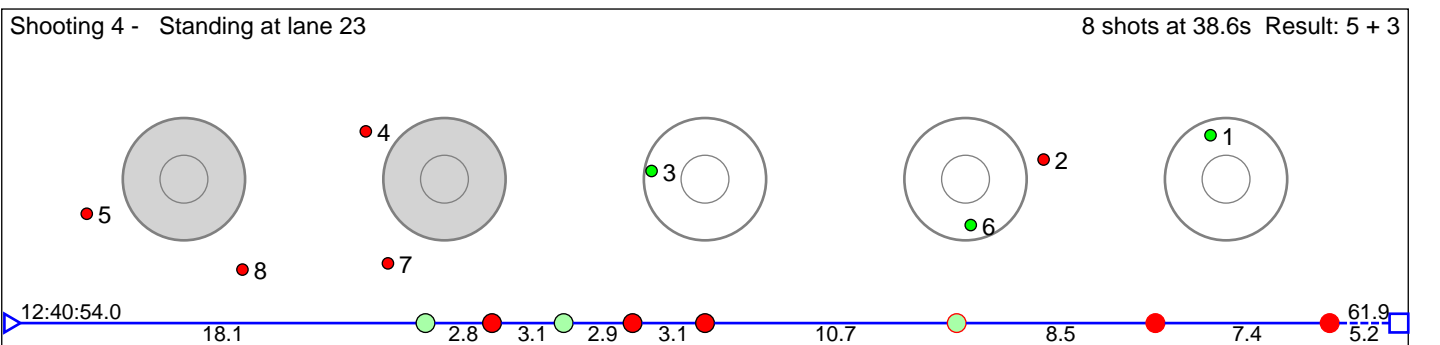
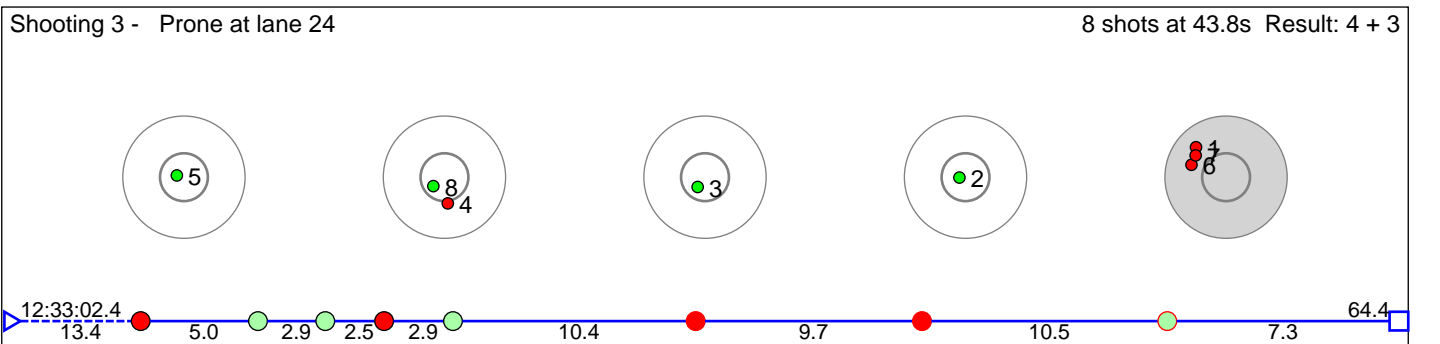
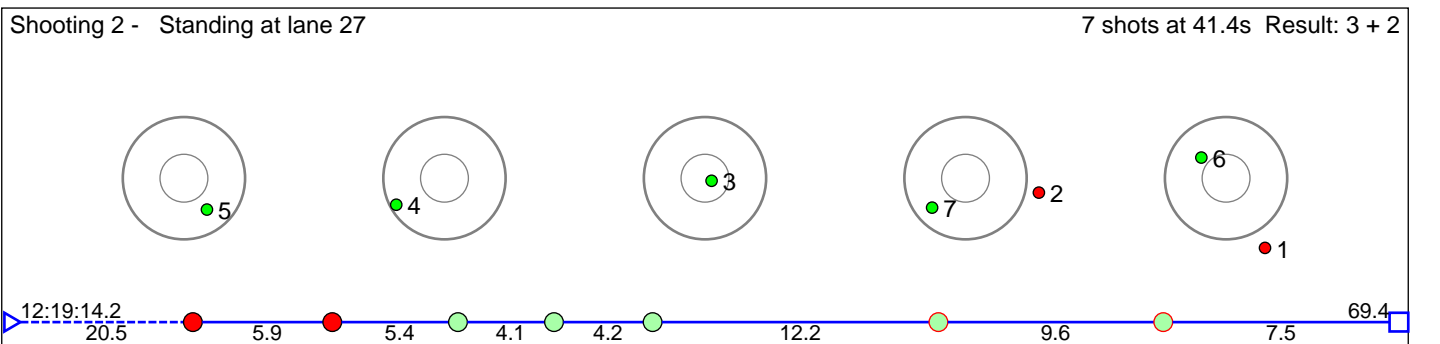
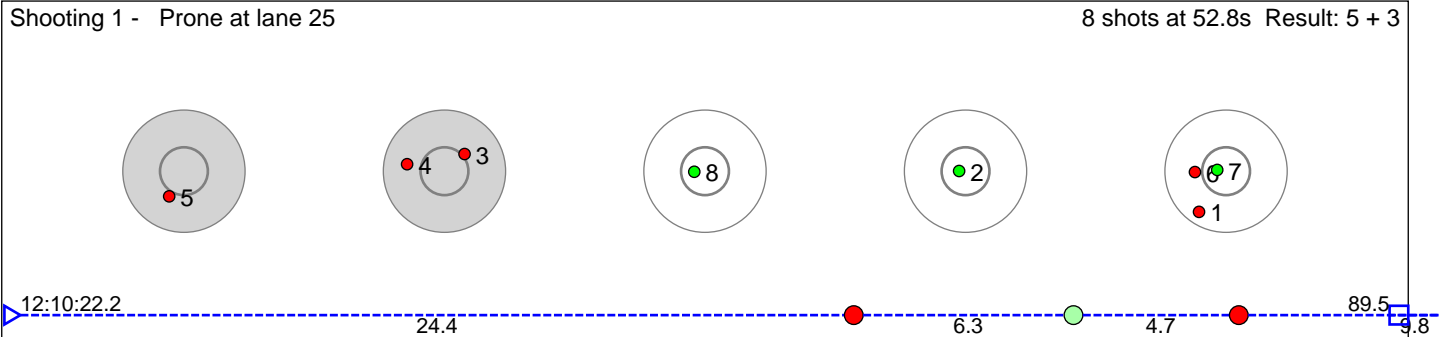

Shooting 5 - Prone at lane 23 8 shots at 59.9s Result: 0 + 3

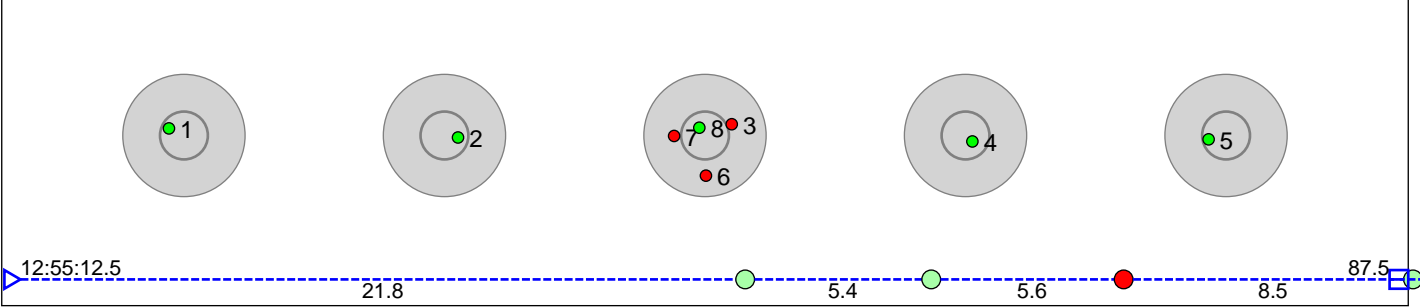

Shooting 6 - Standing at lane 22 7 shots at 39.2s Result: 0 + 2

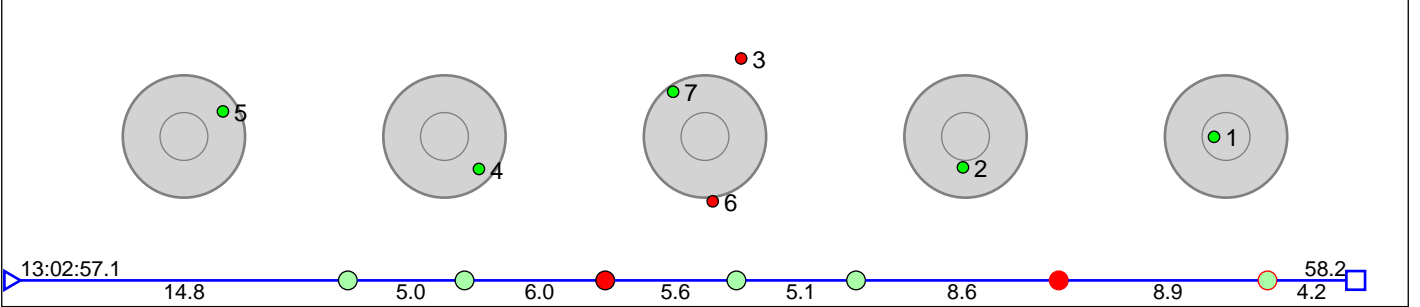

Disclaimer:

These results are unofficial since only the final output from the timing system can provide complete and correct competition results. The graphic plot of each series, presents the location of the shots on each of the five targets. Please observe that the accuracy of the plotting has some limitations due to image resolution and/or printer quality.

83 Sør-Trøndelag SSK 3

Sør-Trøndelag SSK

Result: 17

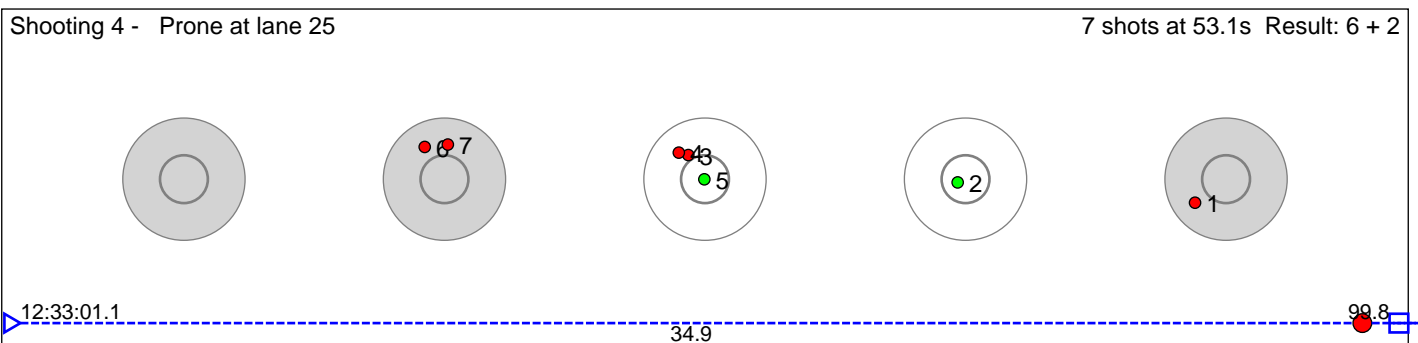
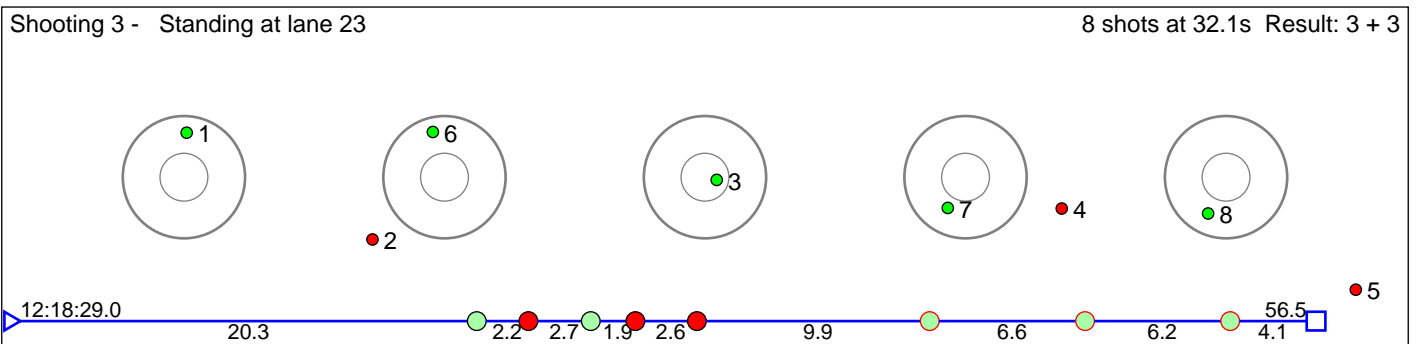
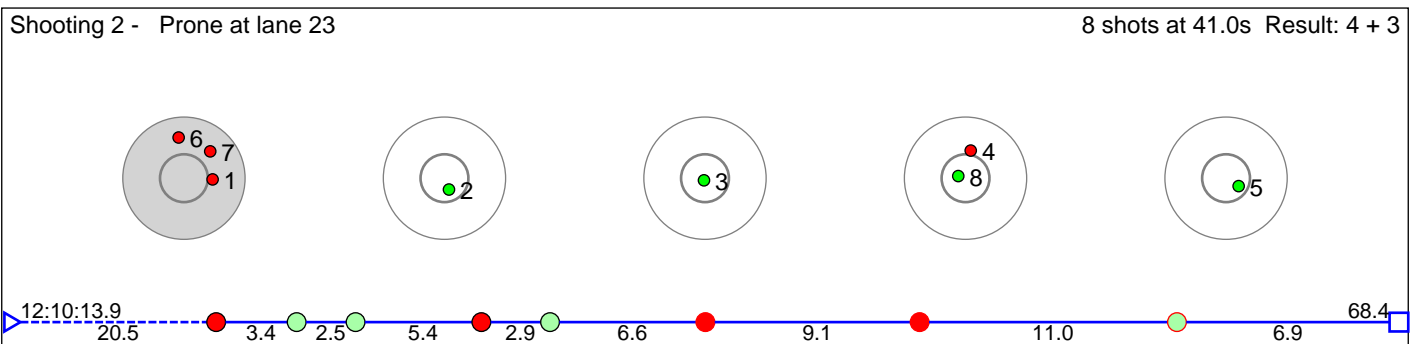
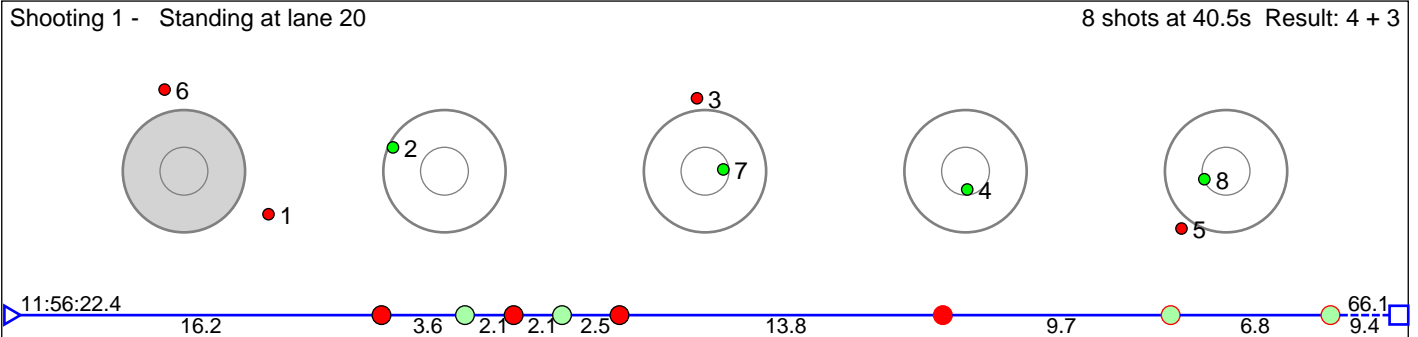

Shooting 5 - Standing at lane 26 8 shots at 32.8s Result: 0 + 3

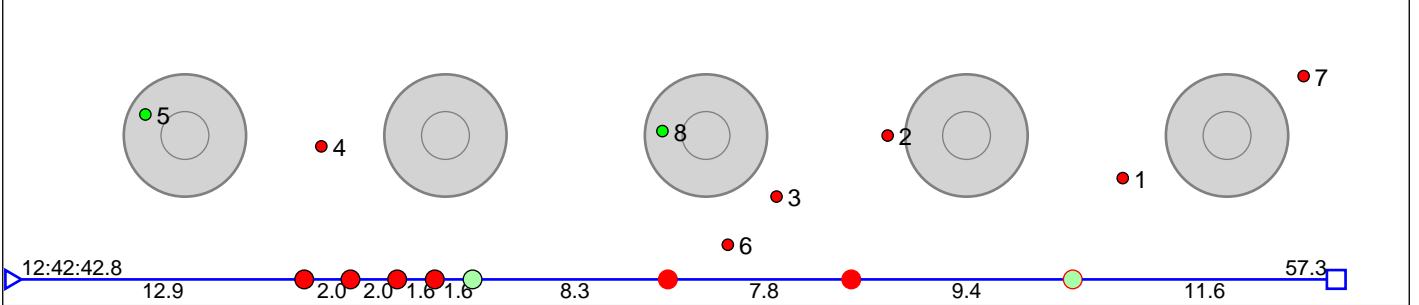

Shooting 6 - Prone at lane 28 8 shots at 46.3s Result: 0 + 3

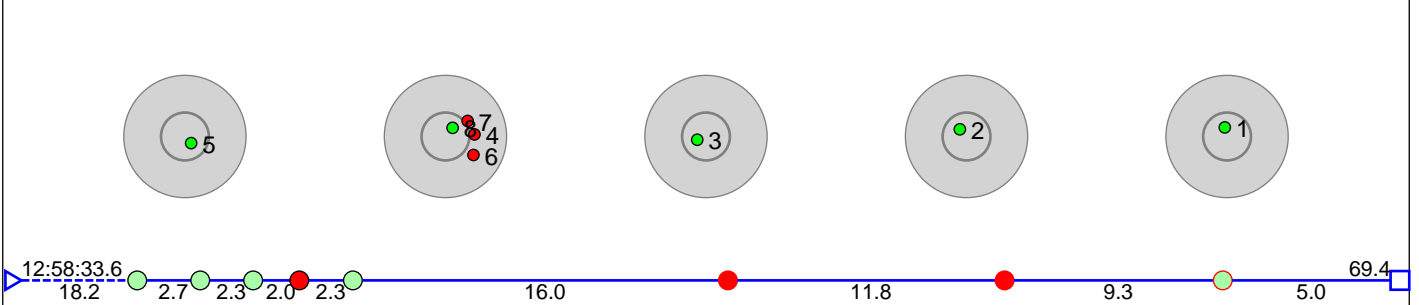

Shooting 7 - Standing at lane 28 8 shots at 45.9s Result: 0 + 3

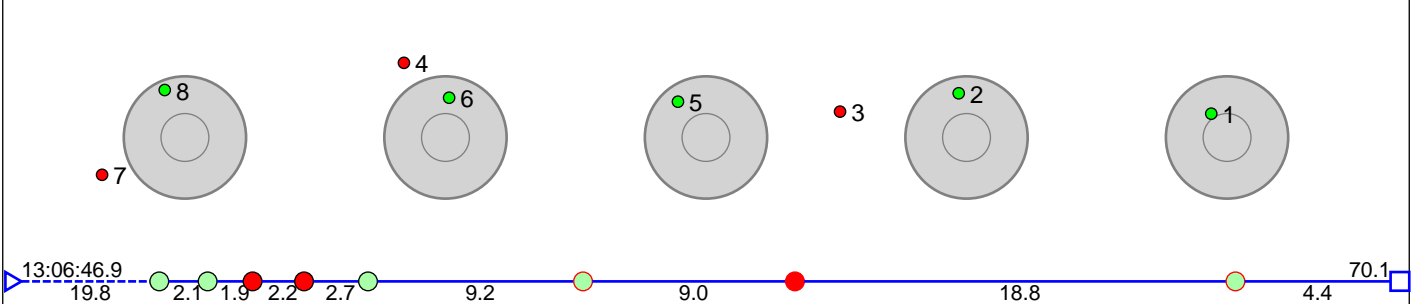

Disclaimer:

These results are unofficial since only the final output from the timing system can provide complete and correct competition results. The graphic plot of each series, presents the location of the shots on each of the five targets. Please observe that the accuracy of the plotting has some limitations due to image resolution and/or printer quality.

84 Buskerud SSK 3

Buskerud SSK

Result: 12

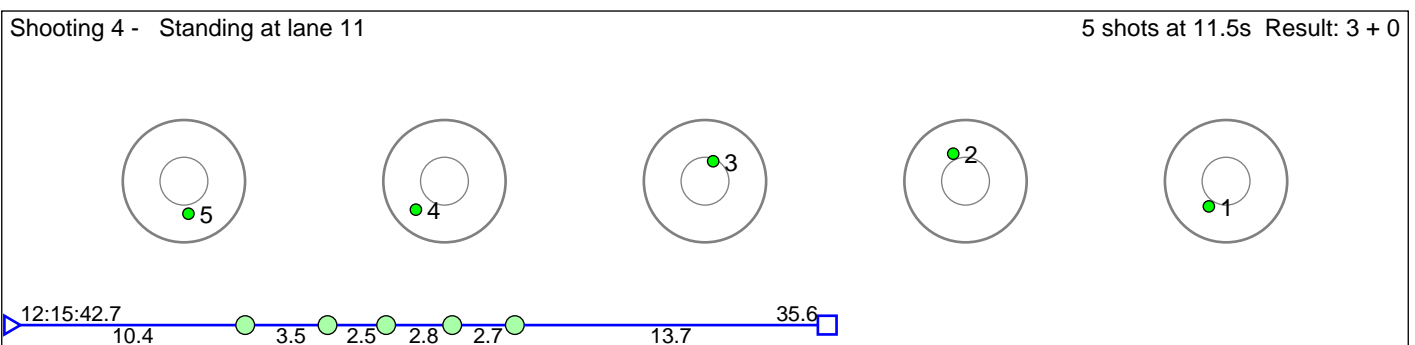
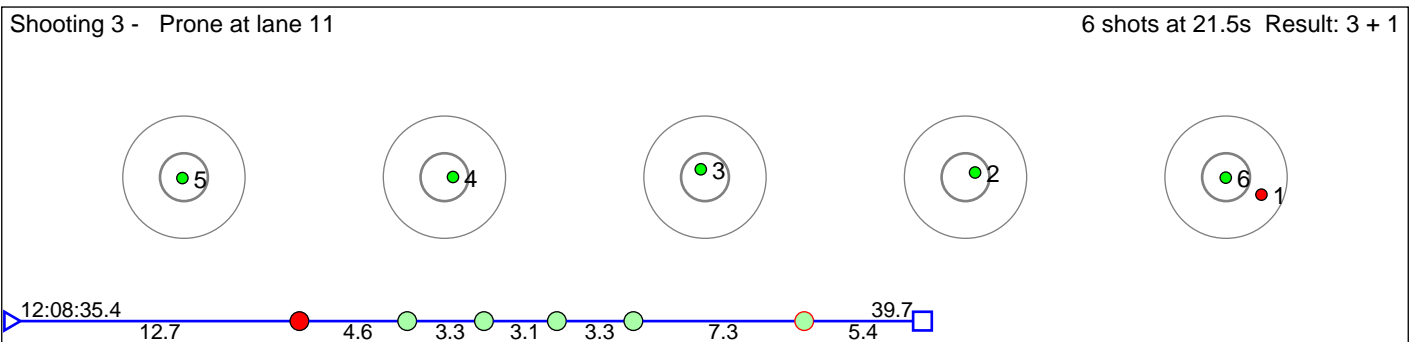
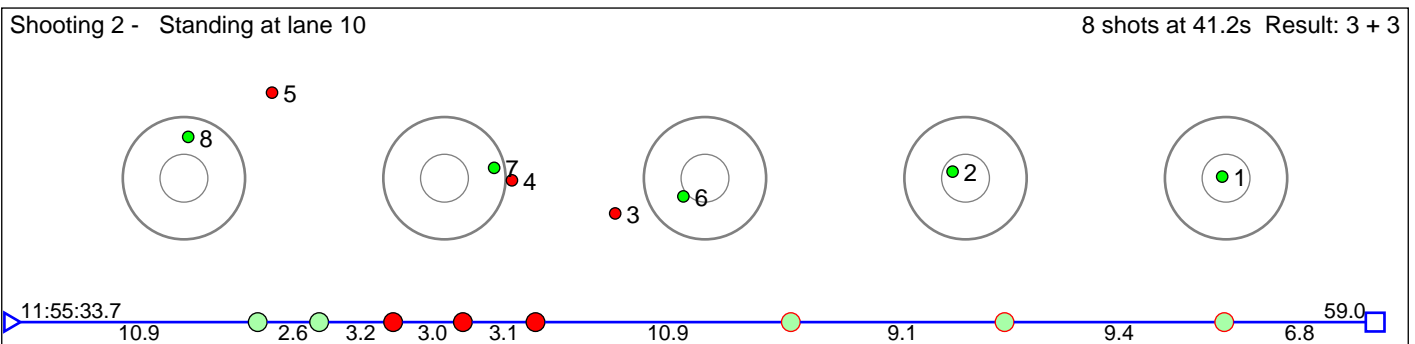
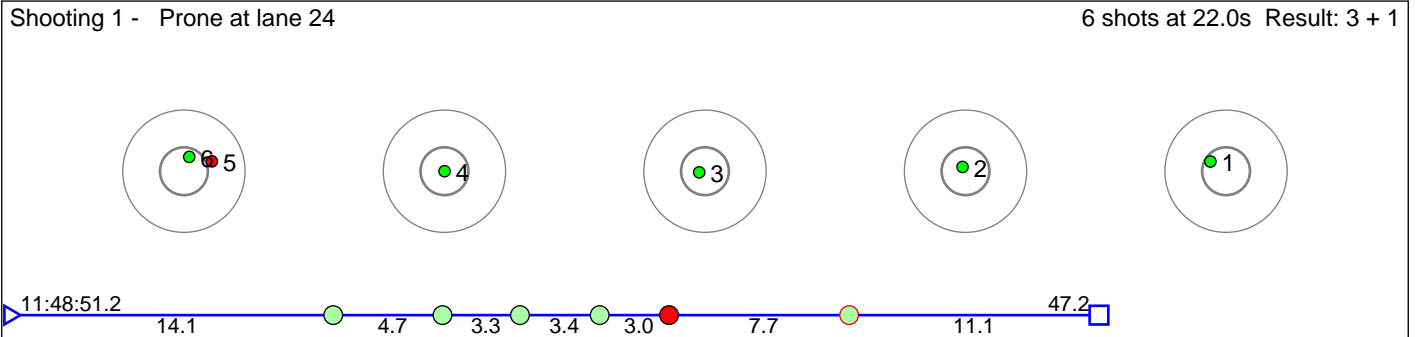

Shooting 5 - Prone at lane 8 8 shots at 38.3s Result: 0 + 3

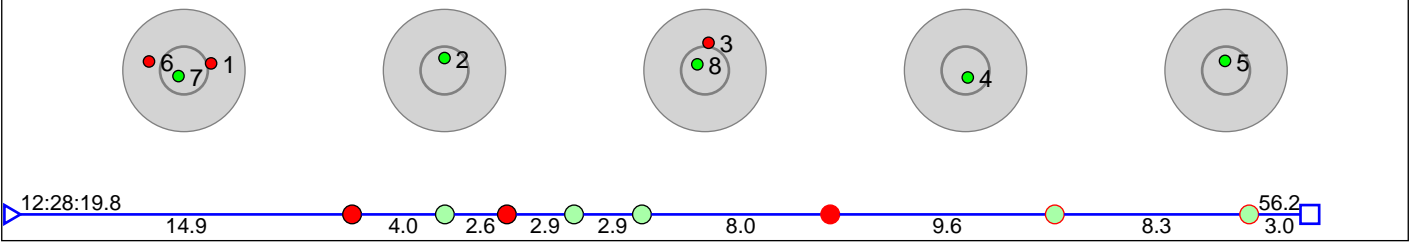

Shooting 6 - Standing at lane 7 8 shots at 35.1s Result: 0 + 3

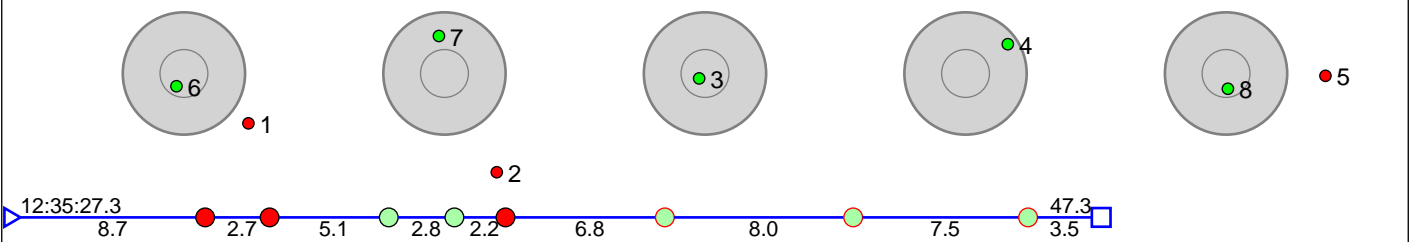

Shooting 7 - Prone at lane 7 5 shots at 10.1s Result: 0 + 0

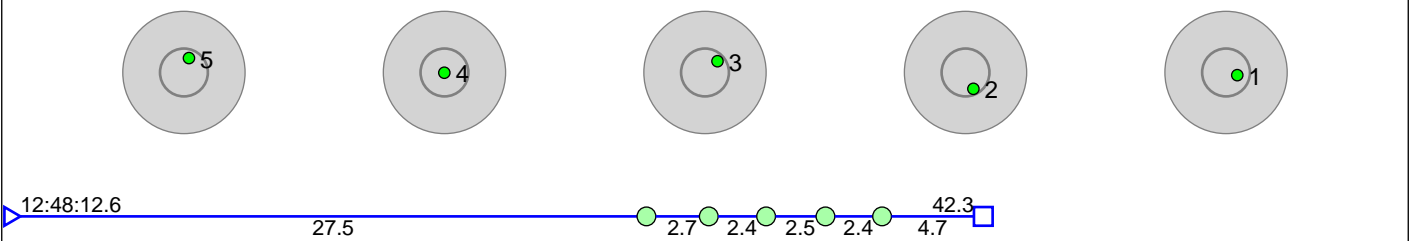

Shooting 8 - Standing at lane 7 8 shots at 41.2s Result: 0 + 3

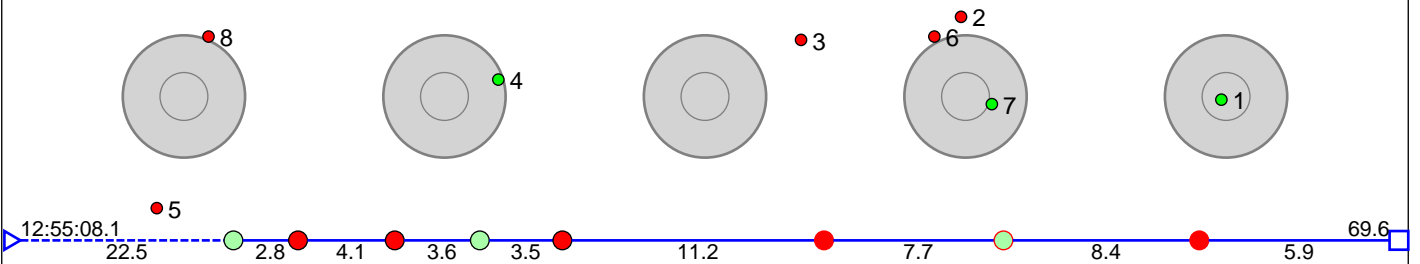

Disclaimer:

These results are unofficial since only the final output from the timing system can provide complete and correct competition results. The graphic plot of each series, presents the location of the shots on each of the five targets. Please observe that the accuracy of the plotting has some limitations due to image resolution and/or printer quality.

85 Oslo og Akershus SSK 4

Oslo og Akershus SSK

Result: 13

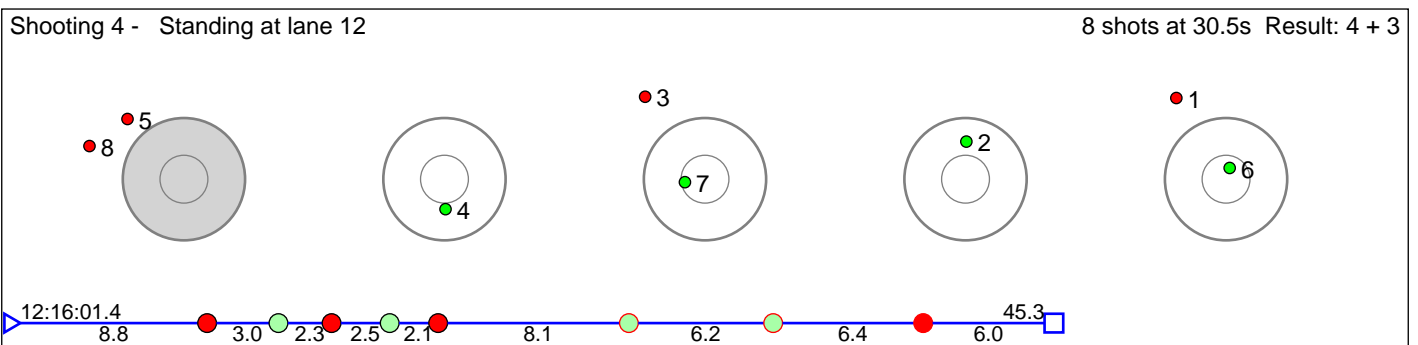
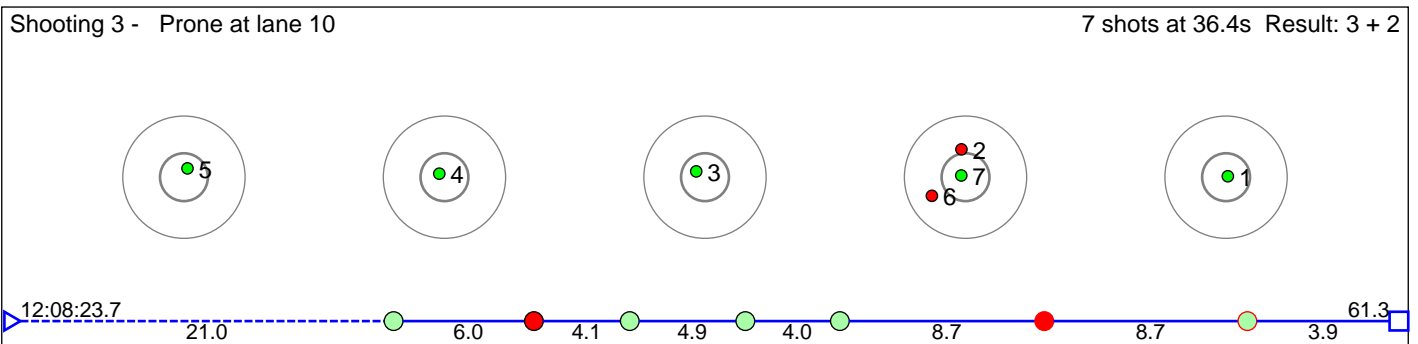
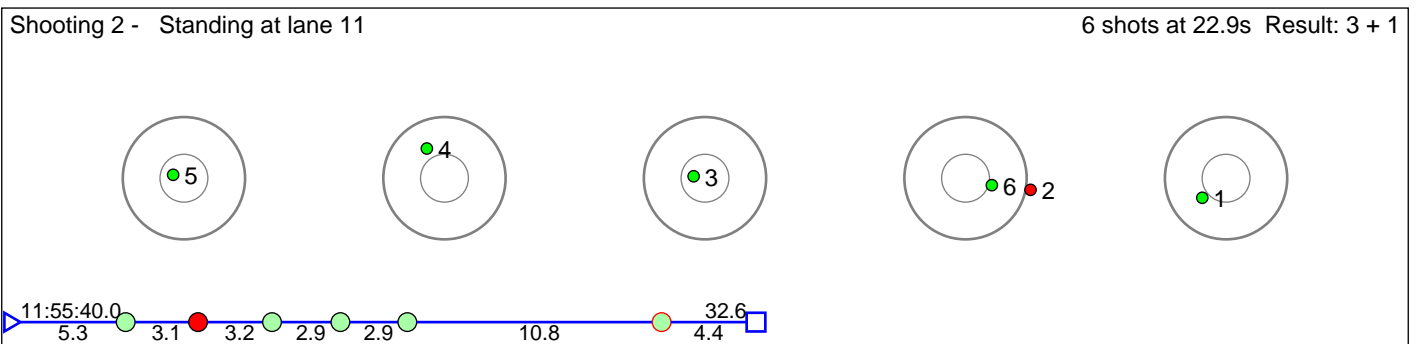
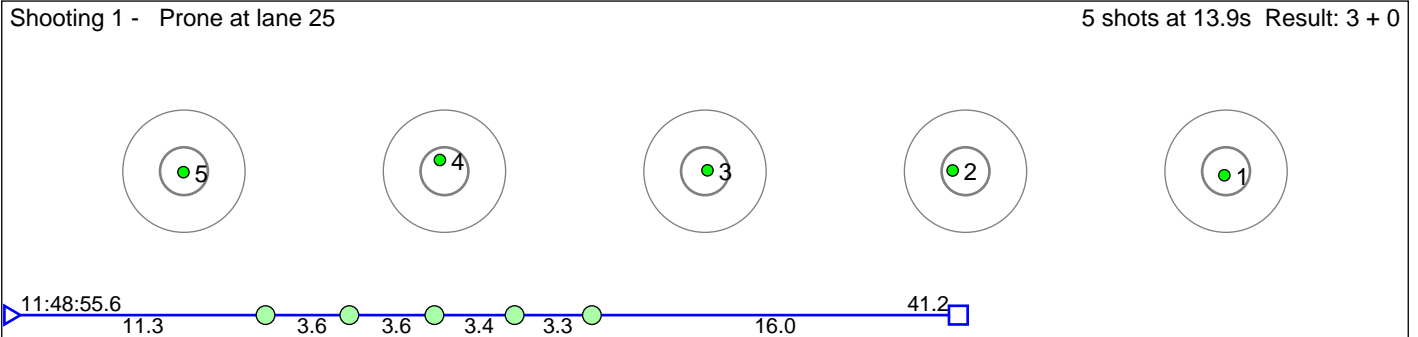

Shooting 5 - Prone at lane 16 7 shots at 35.3s Result: 0 + 2

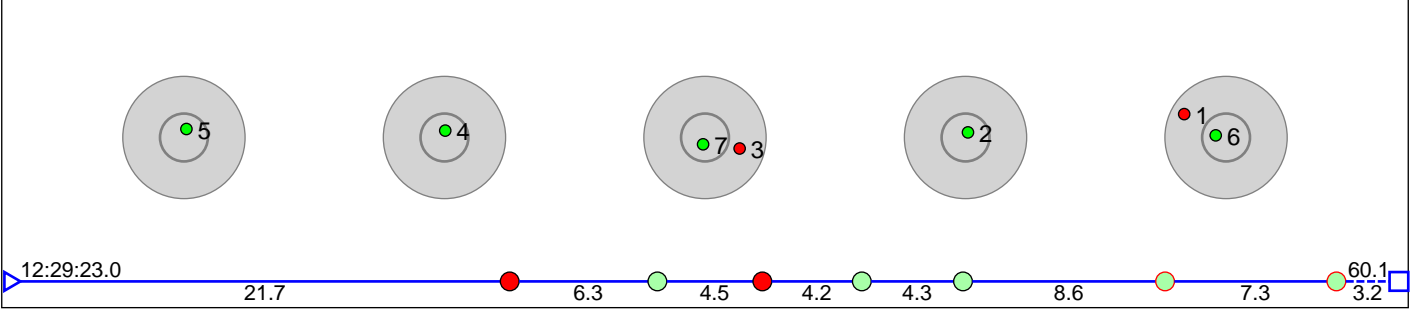

Shooting 6 - Standing at lane 13 8 shots at 35.1s Result: 0 + 3

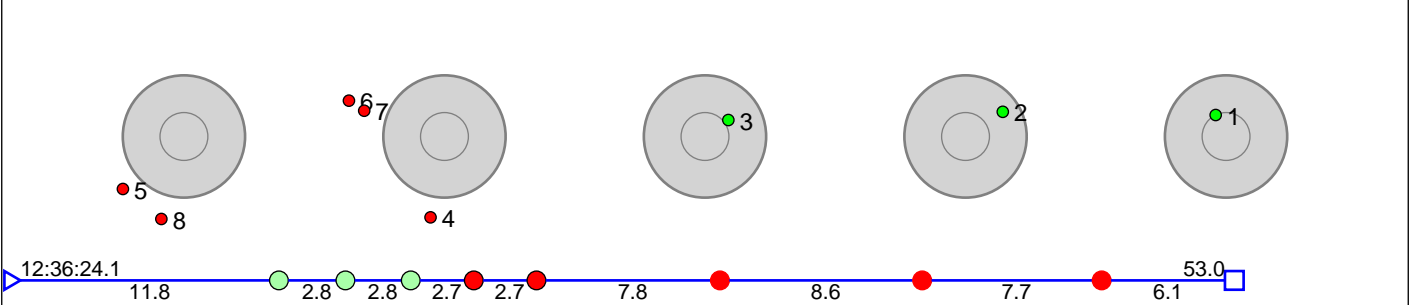

Shooting 7 - Prone at lane 15 8 shots at 36.7s Result: 0 + 3

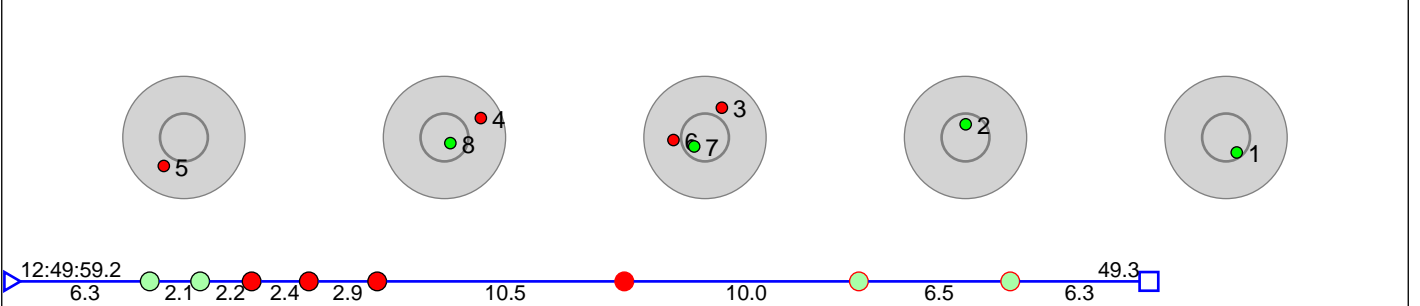

Shooting 8 - Standing at lane 13 8 shots at 62.3s Result: 0 + 3

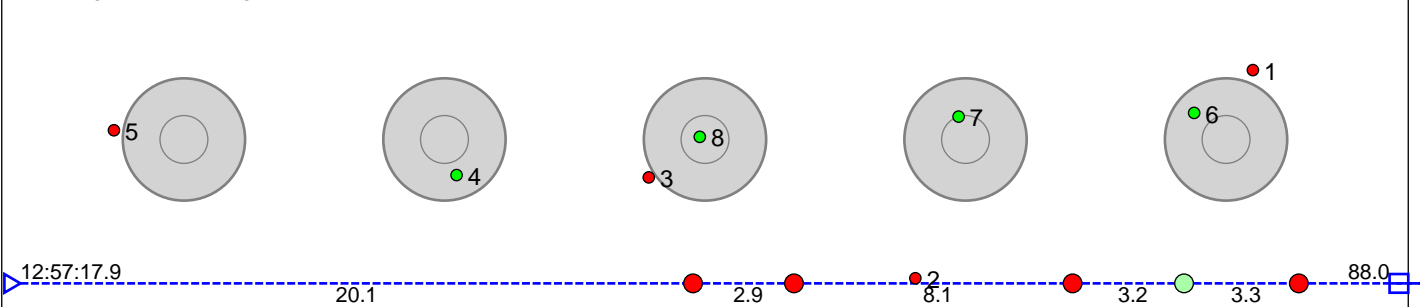

Disclaimer:

These results are unofficial since only the final output from the timing system can provide complete and correct competition results. The graphic plot of each series, presents the location of the shots on each of the five targets. Please observe that the accuracy of the plotting has some limitations due to image resolution and/or printer quality.

86 Oslo og Akershus SSK 5

Oslo og Akershus SSK

Result: 13

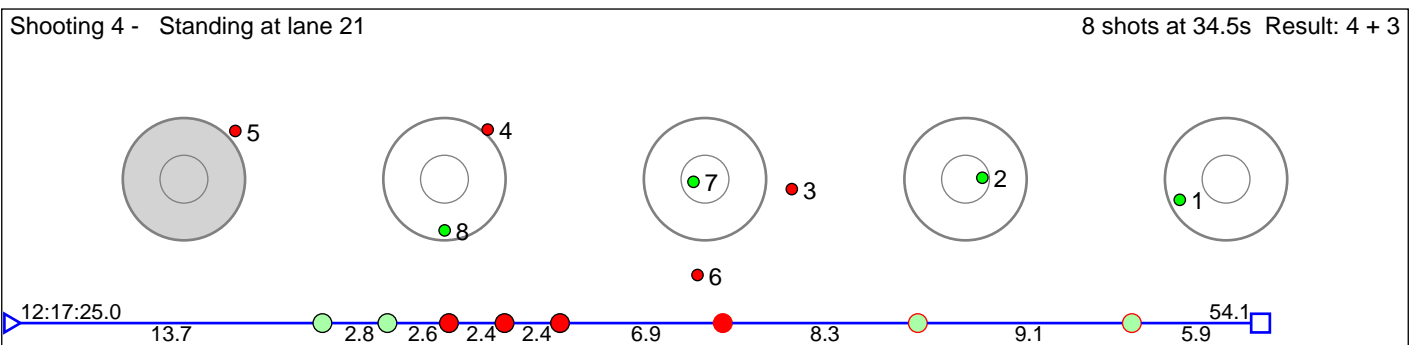
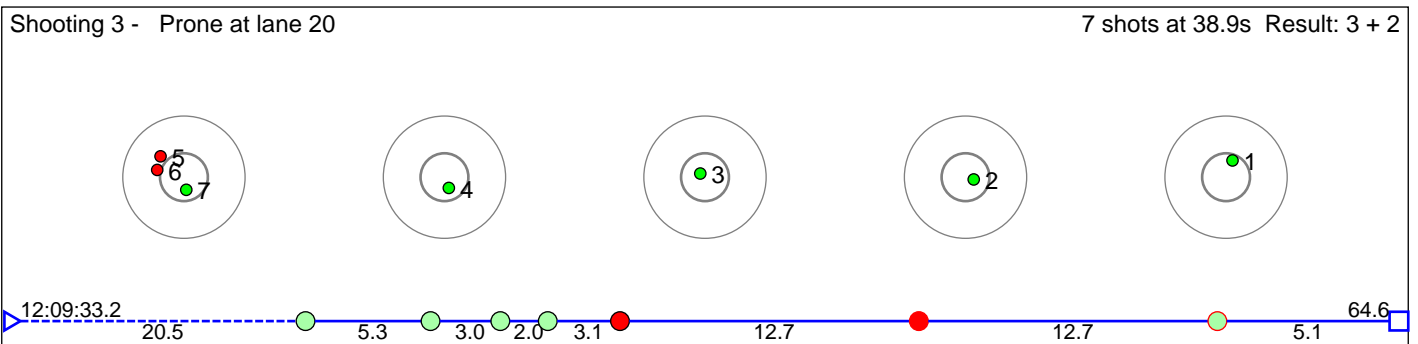
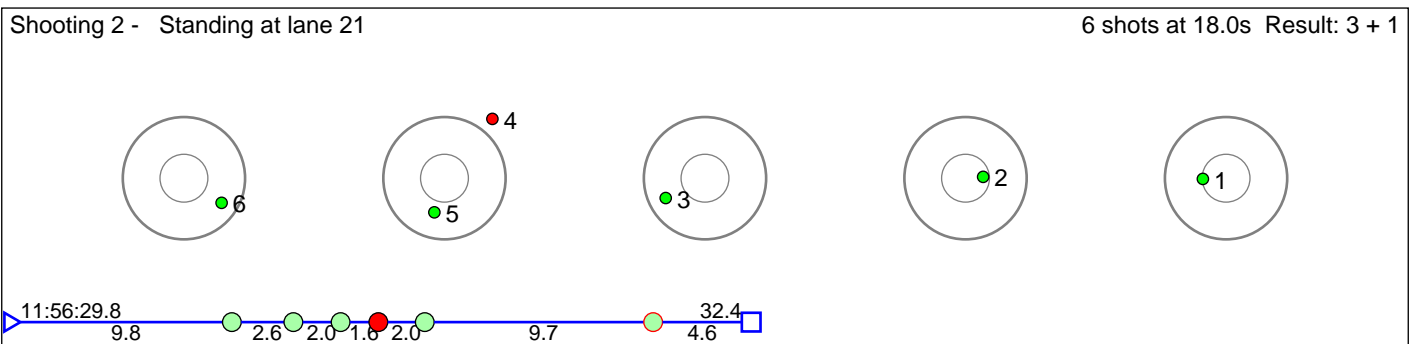
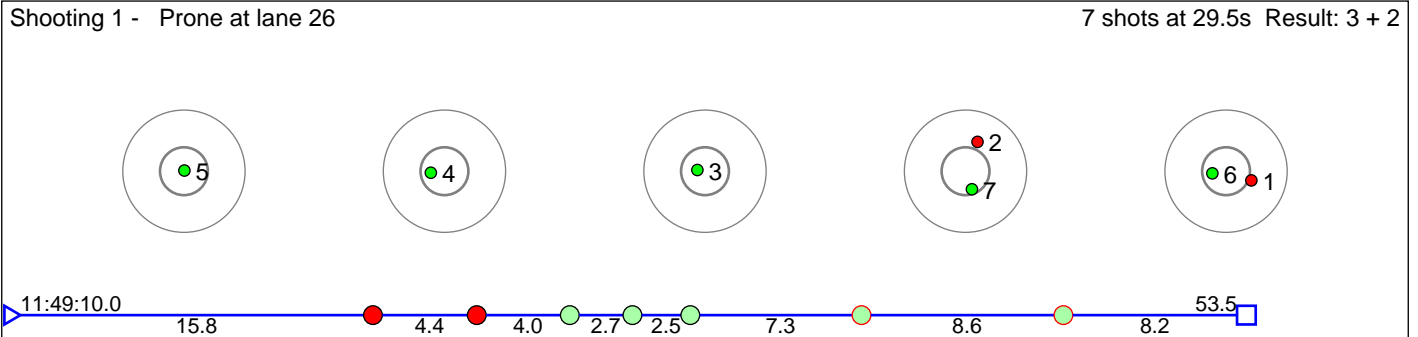

Shooting 5 - Prone at lane 22 5 shots at 8.6s Result: 0 + 0

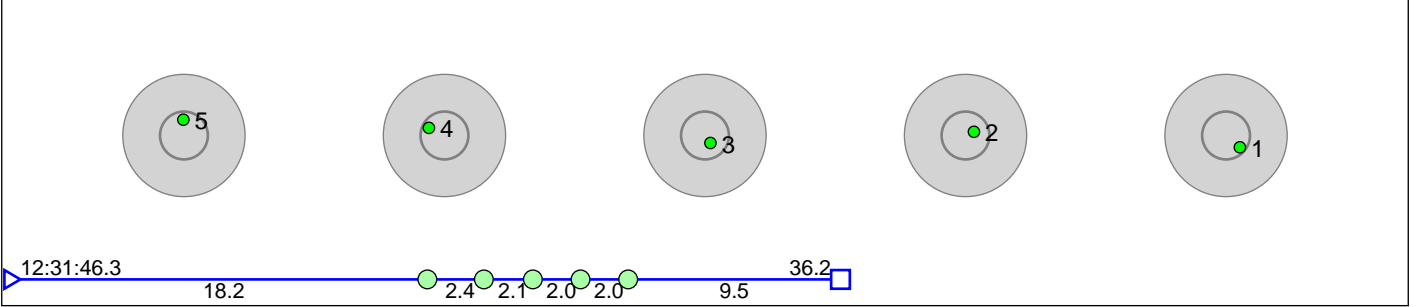

Shooting 6 - Prone at lane 22 8 shots at 47.9s Result: 0 + 3

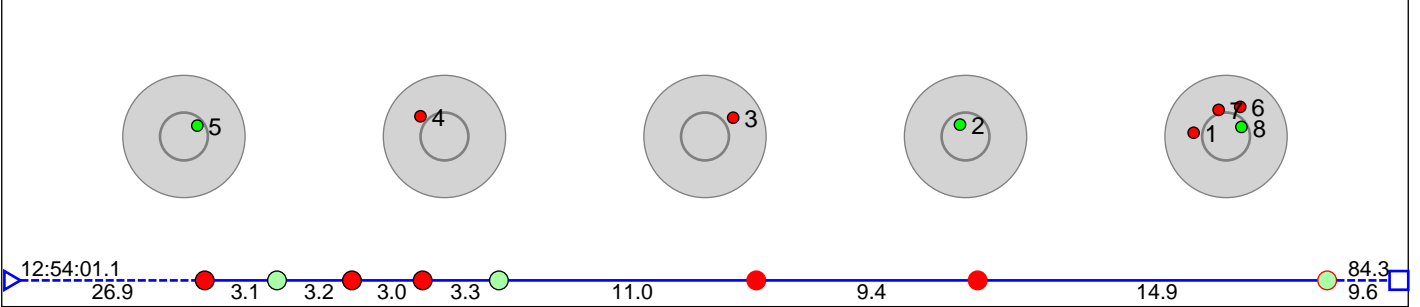

Shooting 7 - Standing at lane 23 8 shots at 38.5s Result: 0 + 3

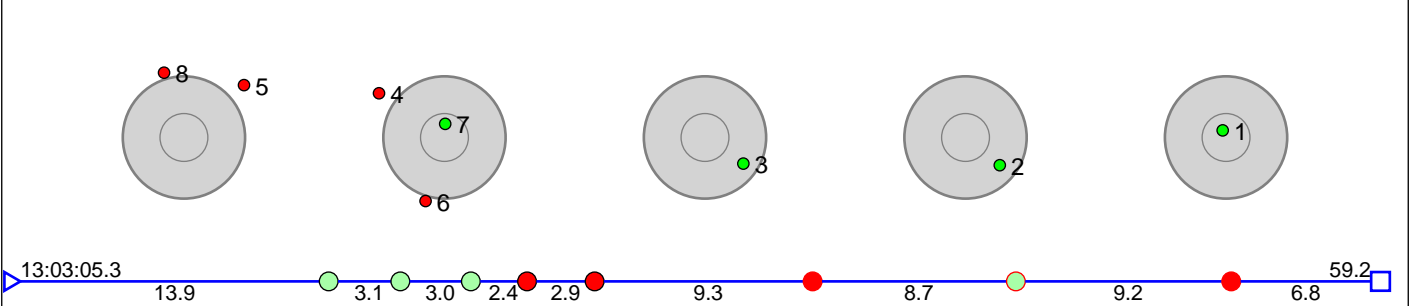

Disclaimer:

These results are unofficial since only the final output from the timing system can provide complete and correct competition results. The graphic plot of each series, presents the location of the shots on each of the five targets. Please observe that the accuracy of the plotting has some limitations due to image resolution and/or printer quality.

87 Oslo og Akershus SSK 6

Oslo og Akershus SSK

Result: 15

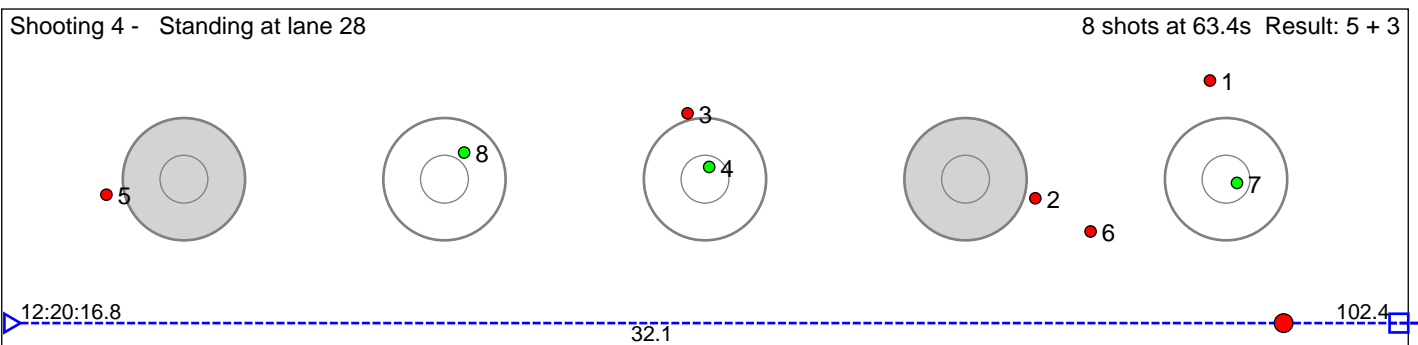
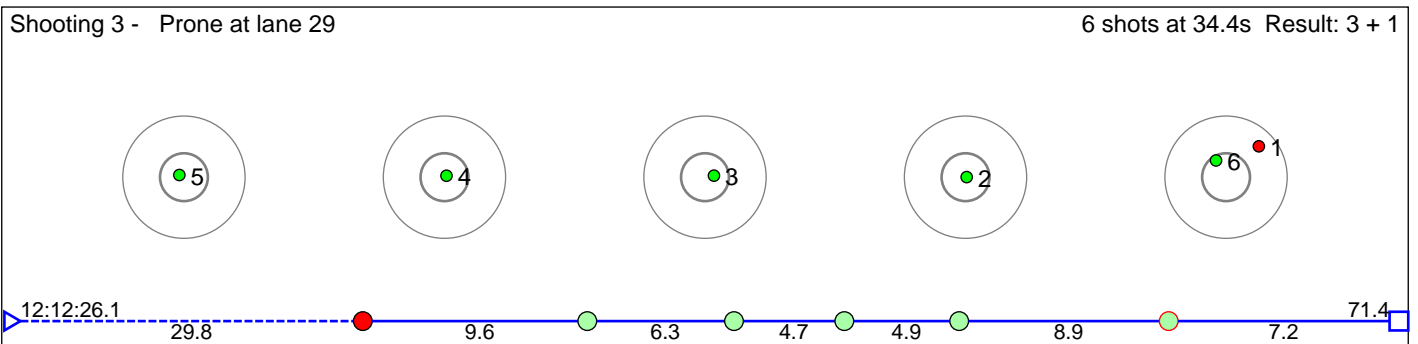
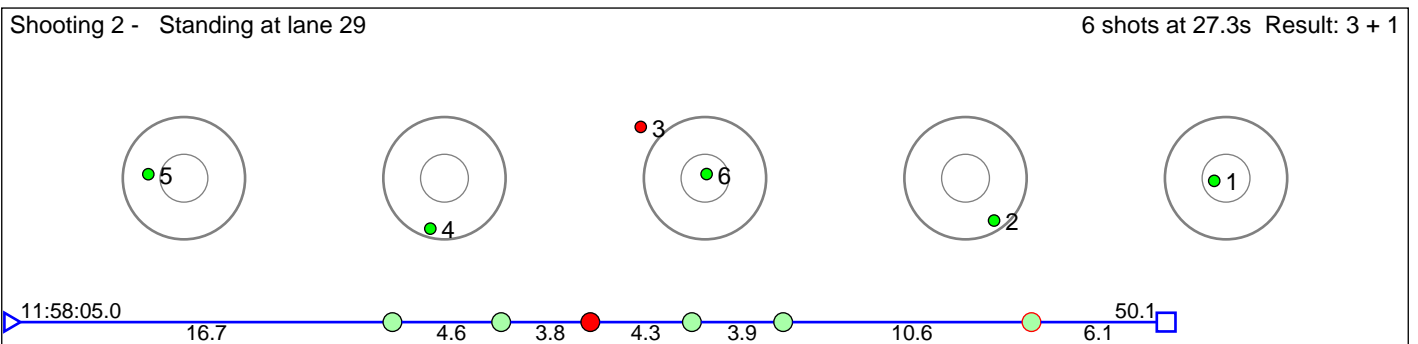
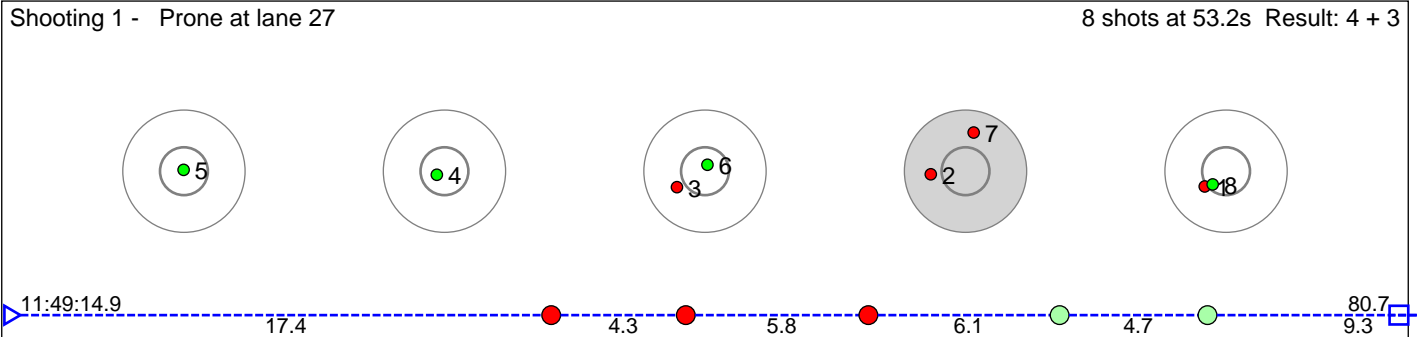

Shooting 5 - Prone at lane 28 8 shots at 50.6s Result: 0 + 3

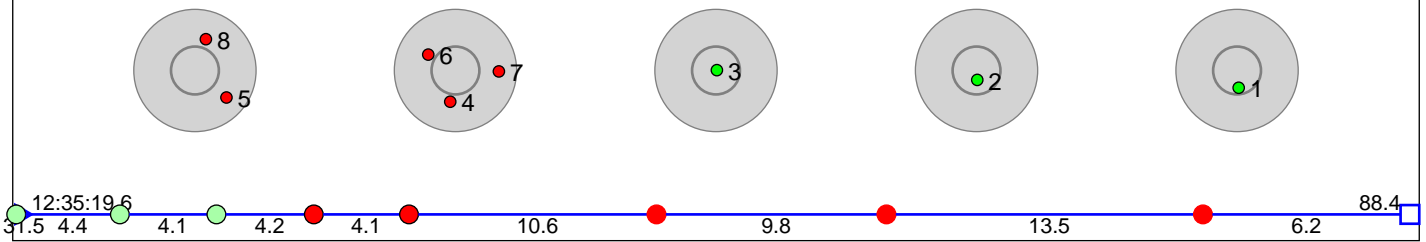

Shooting 6 - Standing at lane 29 8 shots at 45.5s Result: 0 + 3

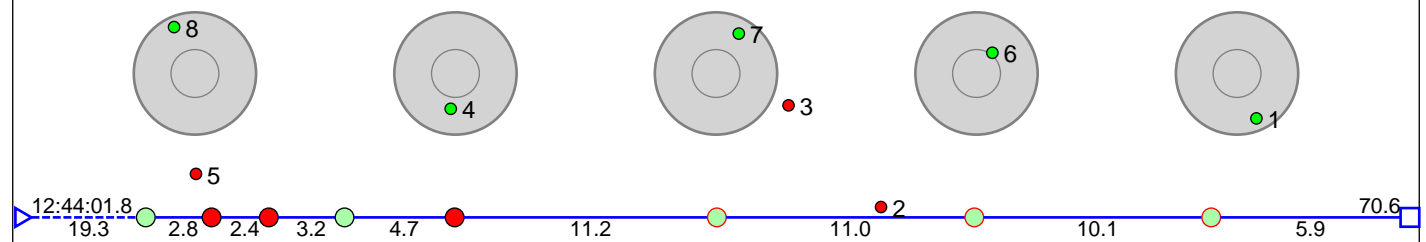

Shooting 7 - Prone at lane 27 8 shots at 39.5s Result: 0 + 3

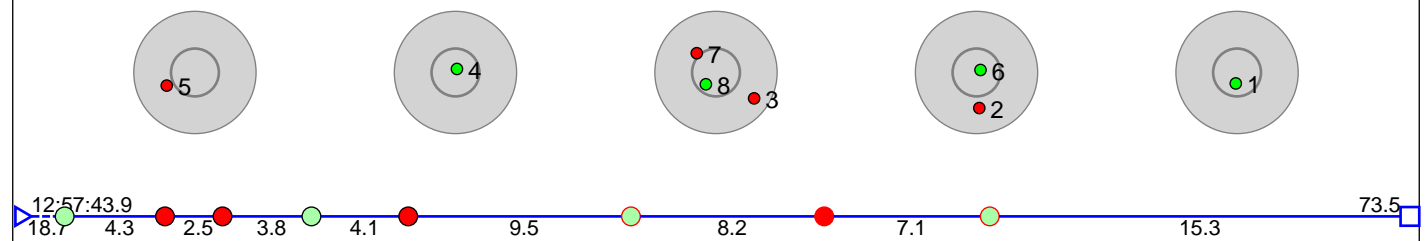

Shooting 8 - Standing at lane 26 8 shots at 48.6s Result: 0 + 3

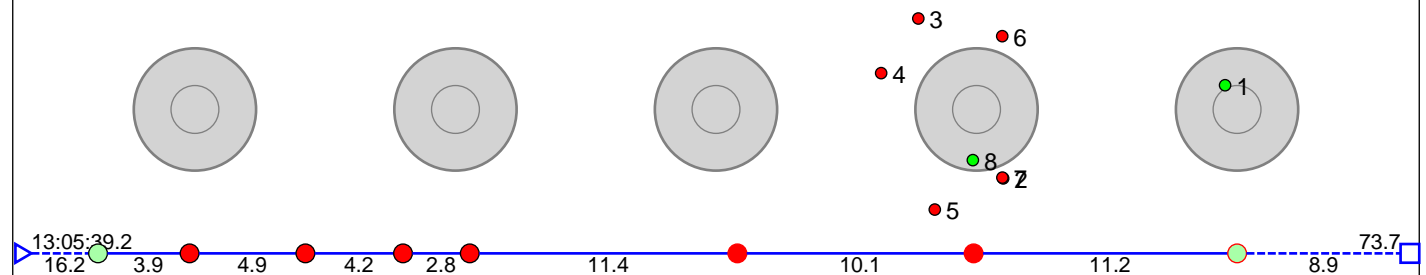

Disclaimer:

These results are unofficial since only the final output from the timing system can provide complete and correct competition results. The graphic plot of each series, presents the location of the shots on each of the five targets. Please observe that the accuracy of the plotting has some limitations due to image resolution and/or printer quality.

88 N-Trøndelag-S-Trøndelag

Result: 14

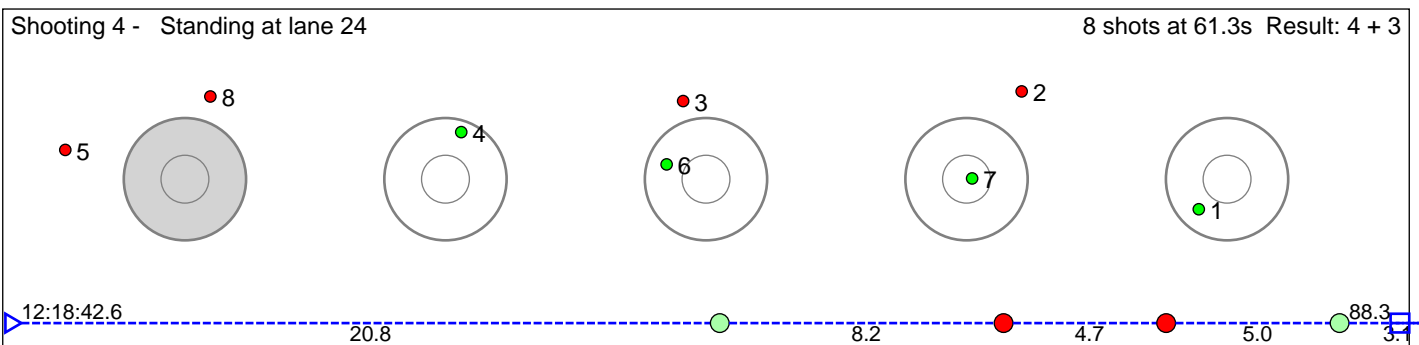
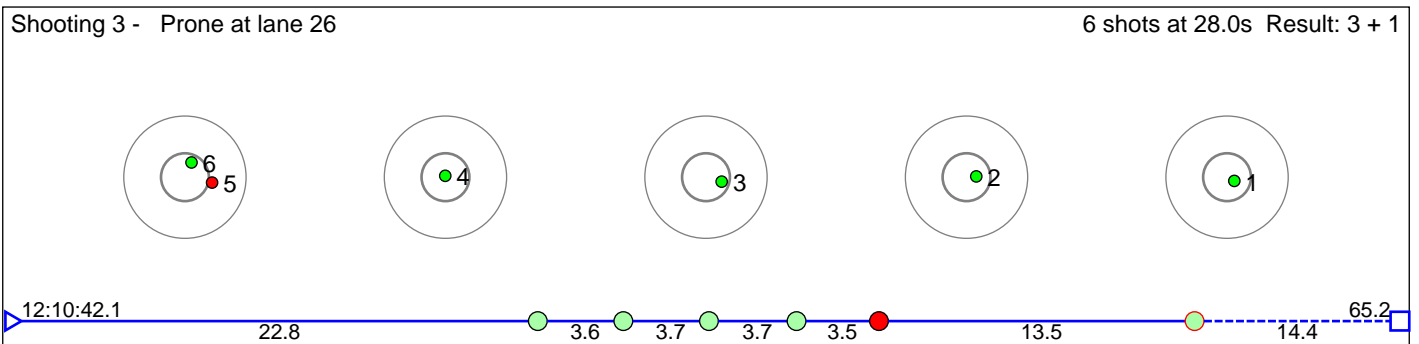
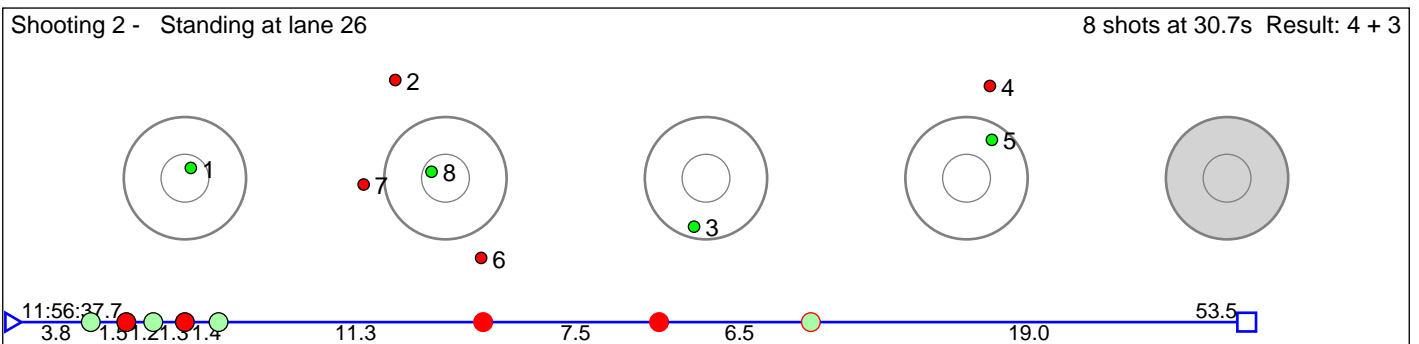
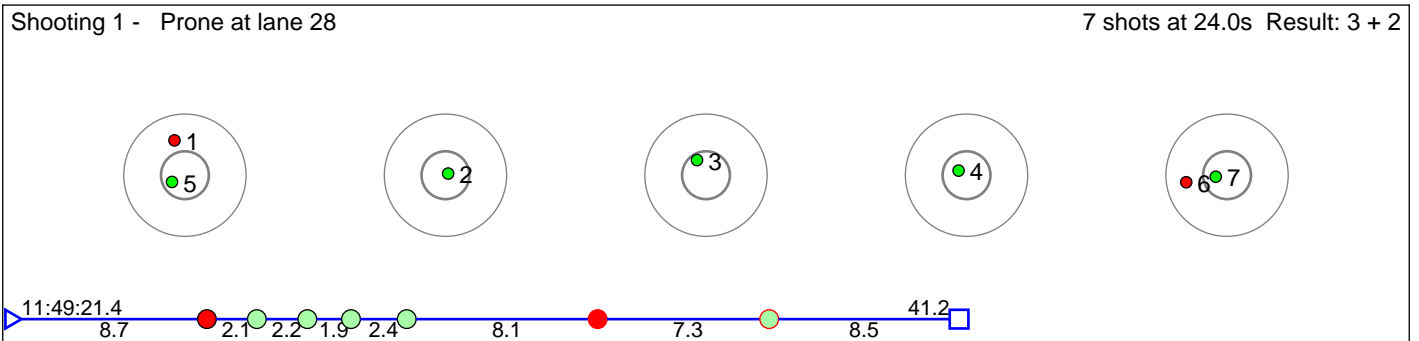

Shooting 5 - Prone at lane 27 7 shots at 47.6s Result: 0 + 2

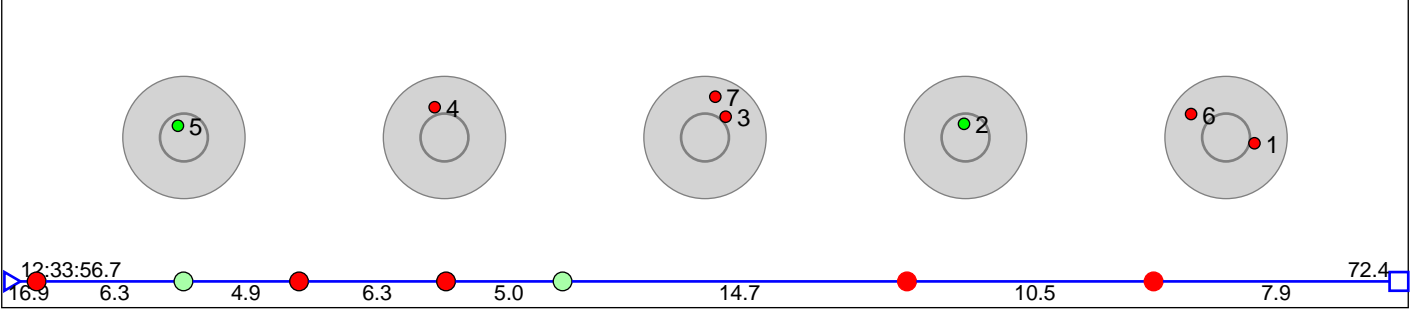

Shooting 6 - Standing at lane 28 8 shots at 38.7s Result: 0 + 3

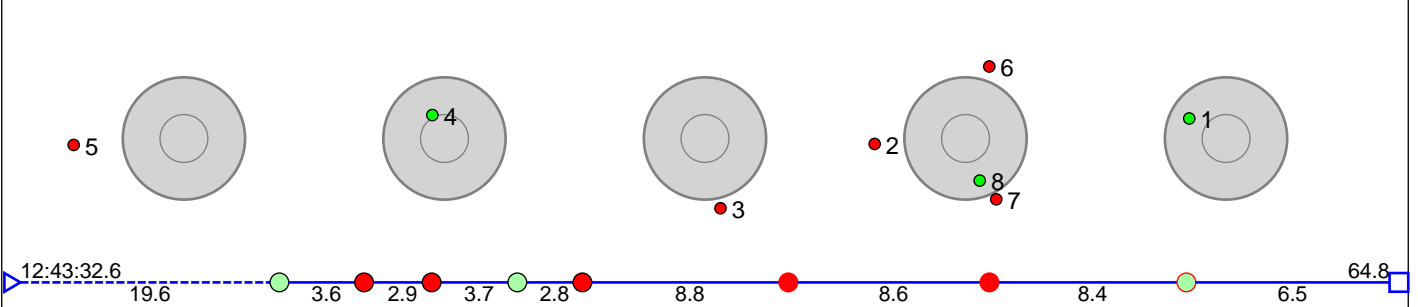

Shooting 7 - Prone at lane 29 8 shots at 52.3s Result: 0 + 3

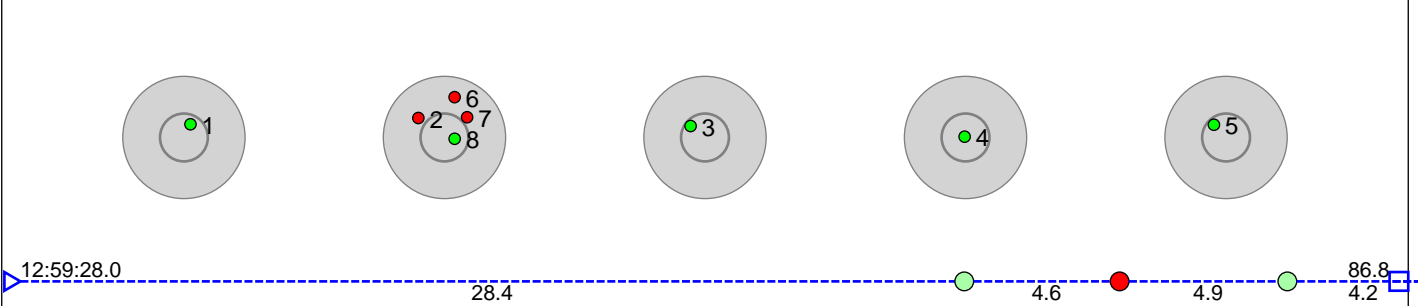

Shooting 8 - Standing at lane 29 8 shots at 40.4s Result: 0 + 3

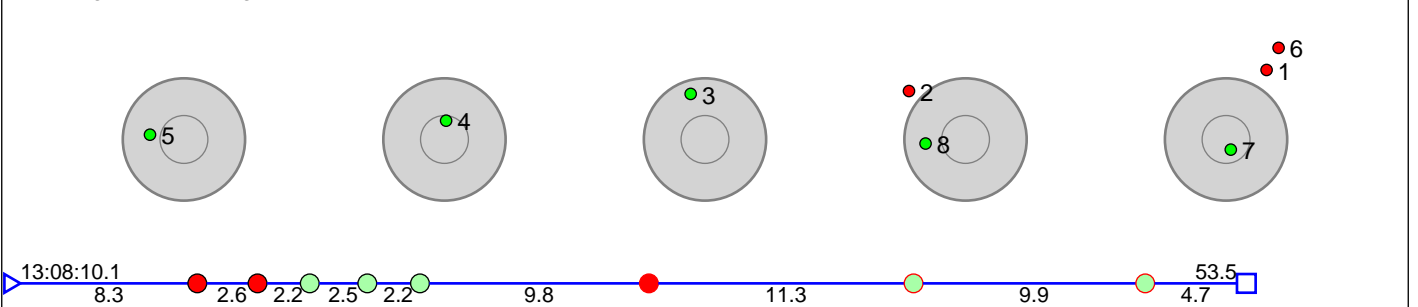

Disclaimer:

These results are unofficial since only the final output from the timing system can provide complete and correct competition results. The graphic plot of each series, presents the location of the shots on each of the five targets. Please observe that the accuracy of the plotting has some limitations due to image resolution and/or printer quality.

89 Finnmark-Buskerud

Result: 14

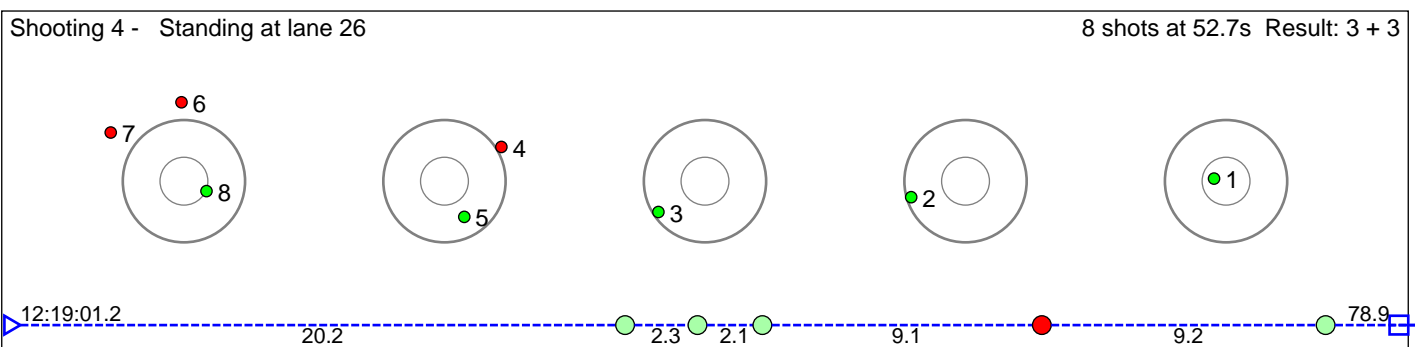
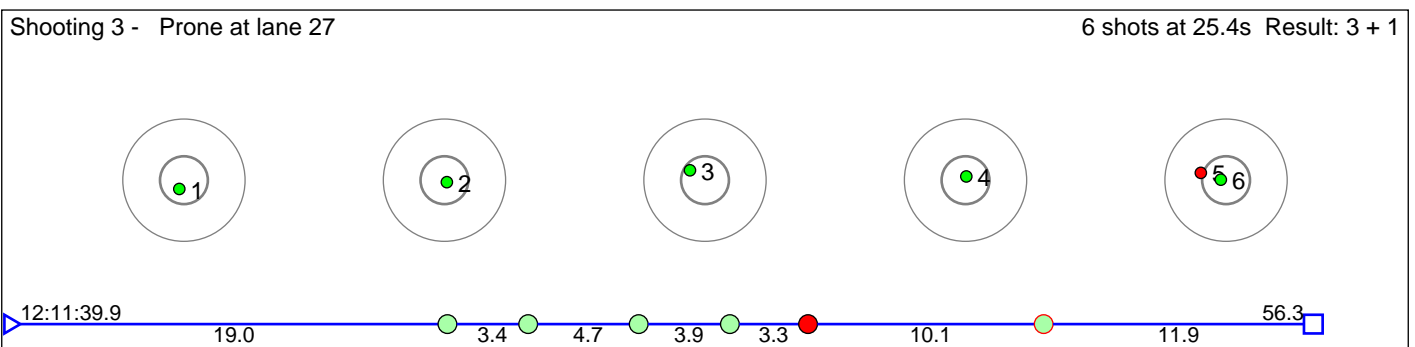
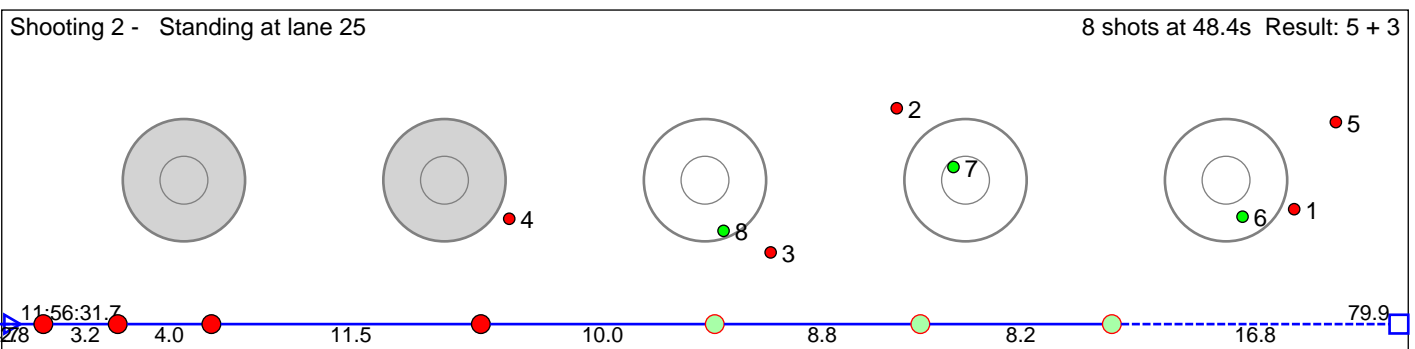
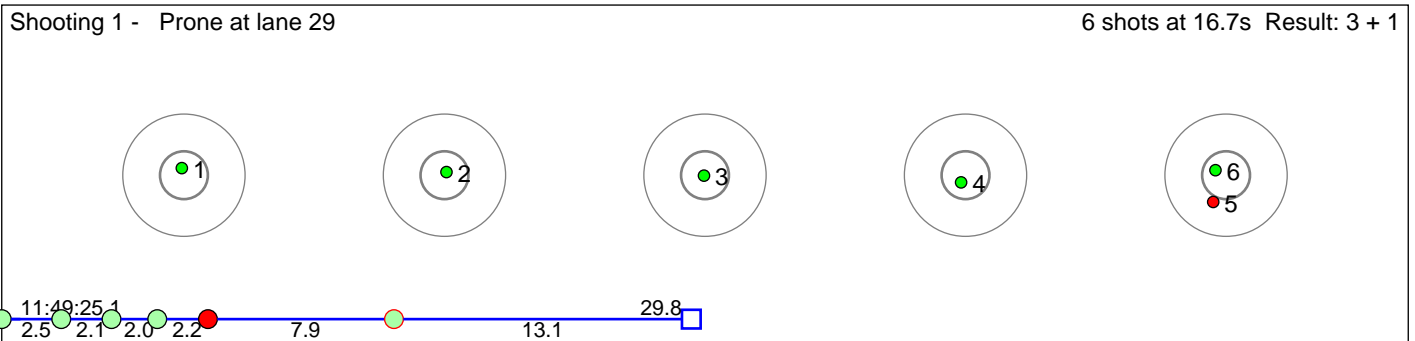

Shooting 5 - Prone at lane 23 8 shots at 49.0s Result: 0 + 3

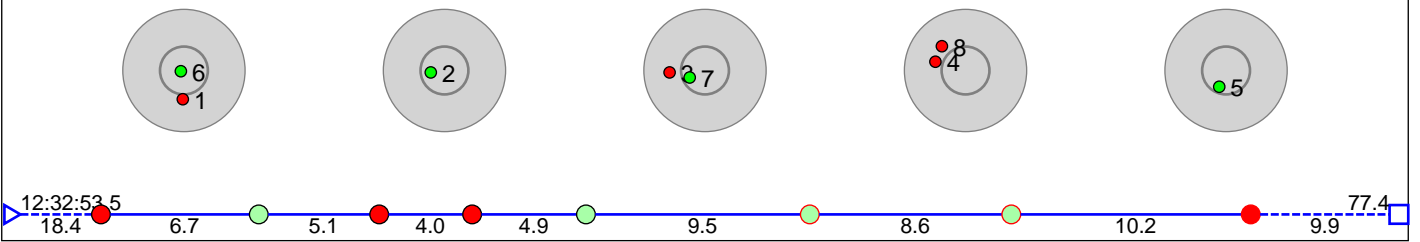

Shooting 6 - Standing at lane 24 8 shots at 38.3s Result: 0 + 3

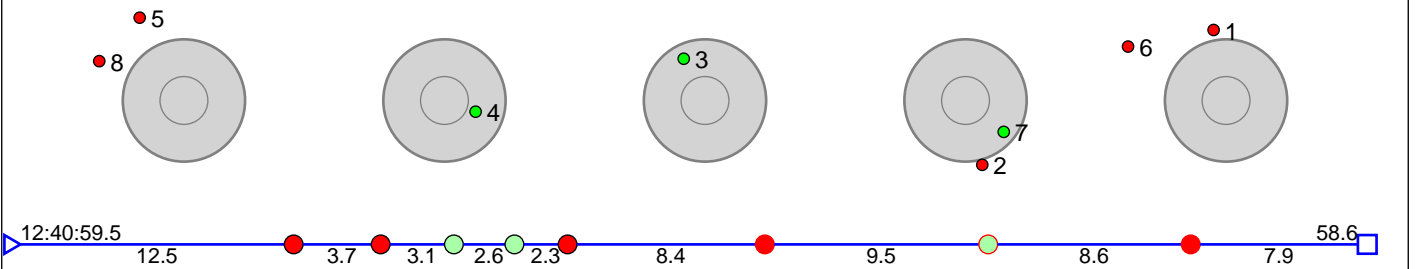

Shooting 7 - Prone at lane 24 6 shots at 26.3s Result: 0 + 1

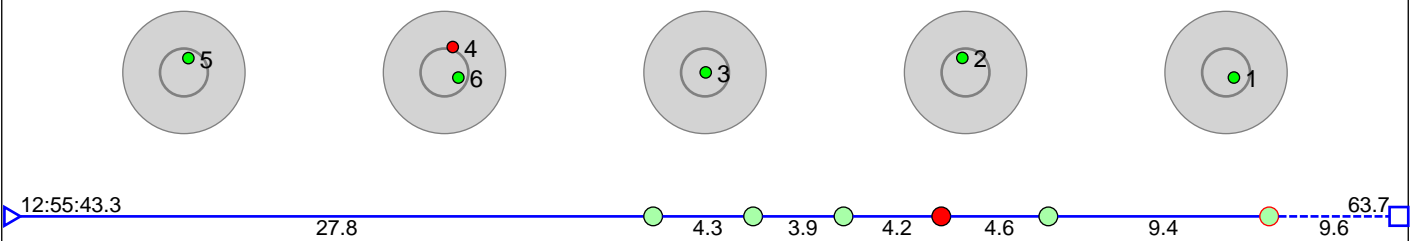

Shooting 8 - Standing at lane 24 7 shots at 44.6s Result: 0 + 2

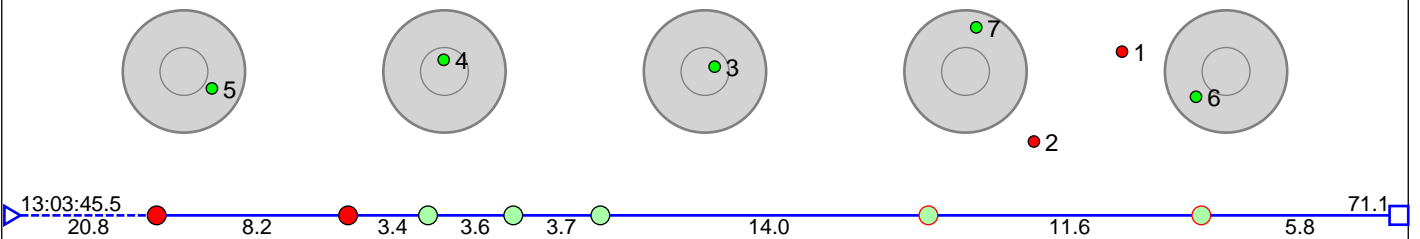

Disclaimer:

These results are unofficial since only the final output from the timing system can provide complete and correct competition results. The graphic plot of each series, presents the location of the shots on each of the five targets. Please observe that the accuracy of the plotting has some limitations due to image resolution and/or printer quality.