

# 511 Skrede Åsne

Geilo IL

Result: 6

Shooting 1 - Prone at lane 1 5 shots at 12.7s Result: 0

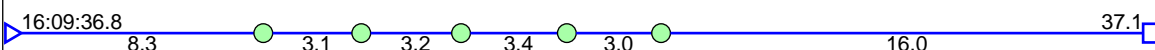
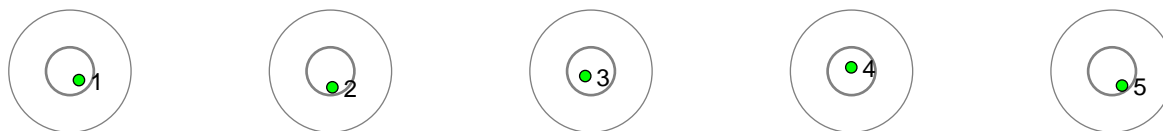

Shooting 2 - Prone at lane 1 5 shots at 12.4s Result: 2

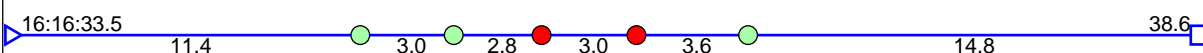
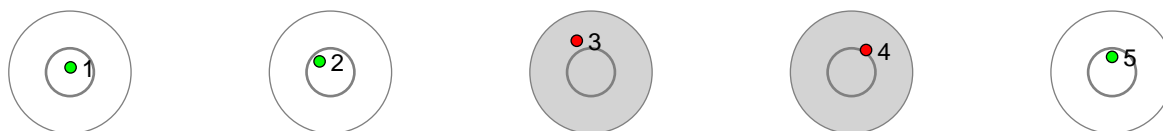

Shooting 3 - Standing at lane 4 5 shots at 12.6s Result: 1

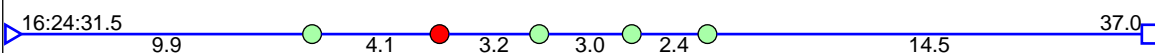
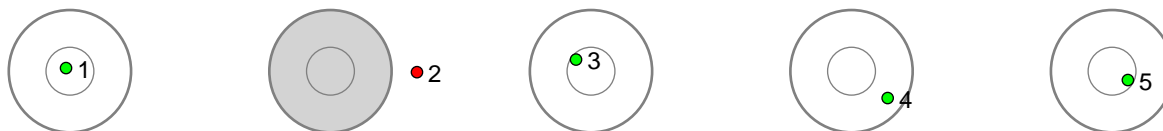

Shooting 4 - Standing at lane 3 5 shots at 10.4s Result: 3

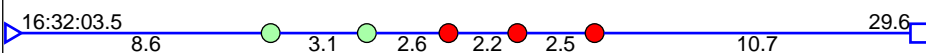
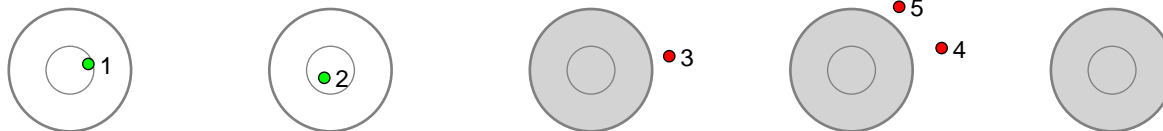

**Disclaimer:**

These results are unofficial since only the final output from the timing system can provide complete and correct competition results. The graphic plot of each series, presents the location of the shots on each of the five targets. Please observe that the accuracy of the plotting has some limitations due to image resolution and/or printer quality.

# 512 Grue Eline

Kvikne IL

Result: 3

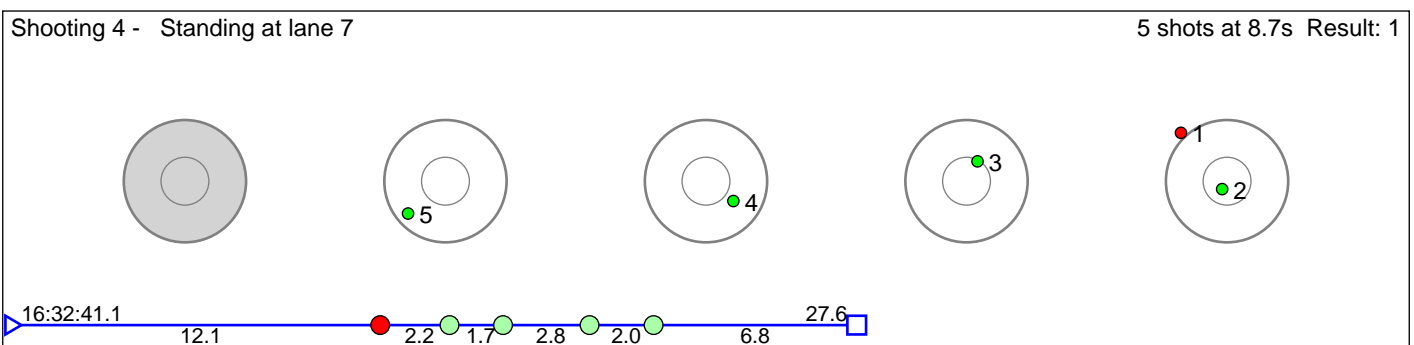
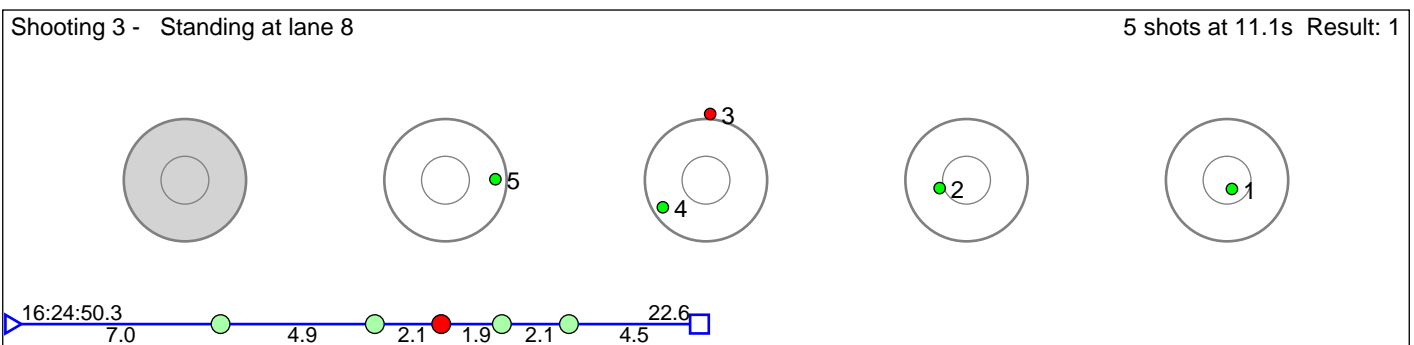
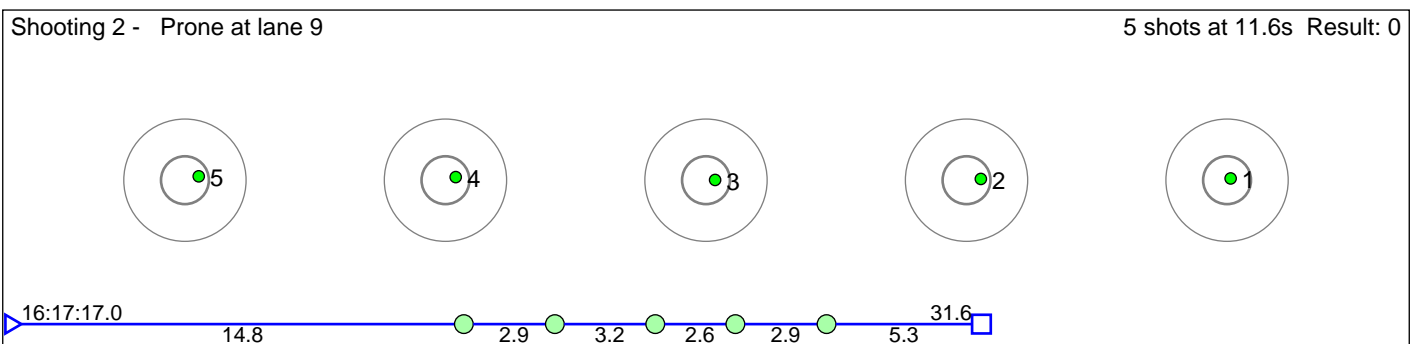
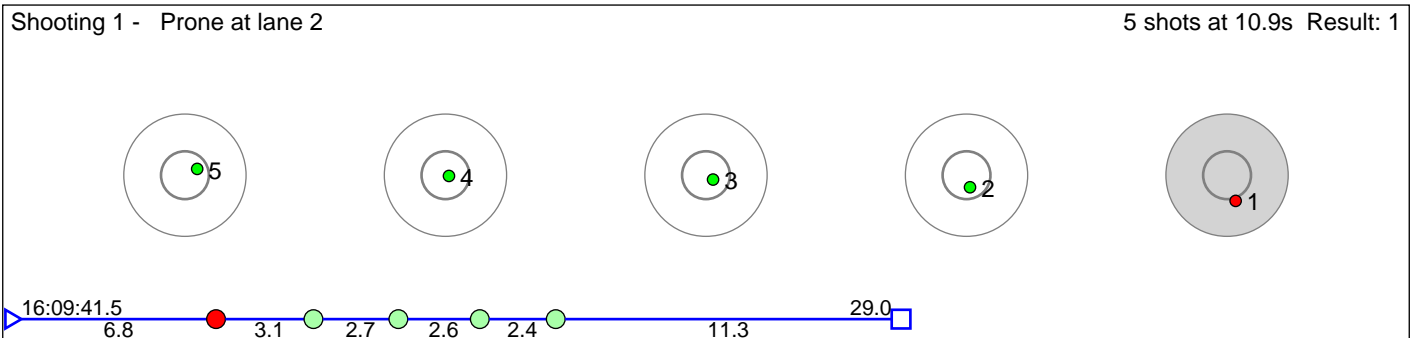

**Disclaimer:**

These results are unofficial since only the final output from the timing system can provide complete and correct competition results. The graphic plot of each series, presents the location of the shots on each of the five targets. Please observe that the accuracy of the plotting has some limitations due to image resolution and/or printer quality.

# 513 Skogan Marit Ishol

Steinkjer Skiklubb

Result: 2

Shooting 1 - Prone at lane 3

5 shots at 14.3s Result: 0

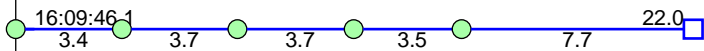
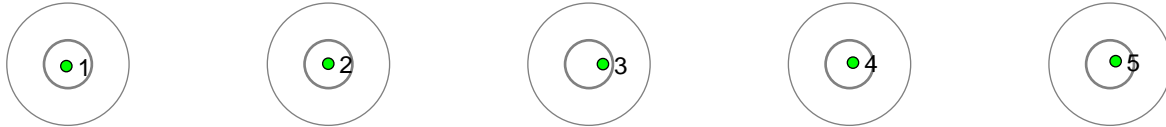

Shooting 2 - Prone at lane 3

5 shots at 13.7s Result: 0

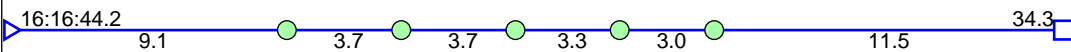
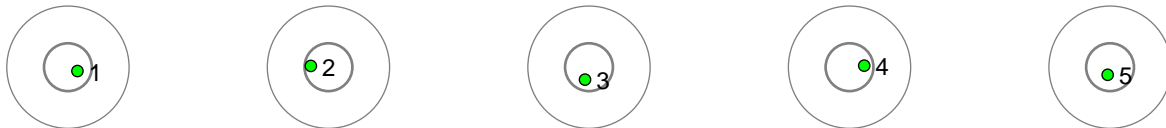

Shooting 3 - Standing at lane 2

5 shots at 12.5s Result: 1

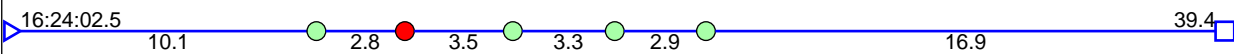
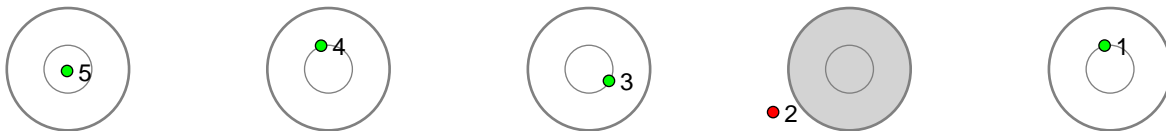

Shooting 4 - Standing at lane 2

5 shots at 12.1s Result: 1

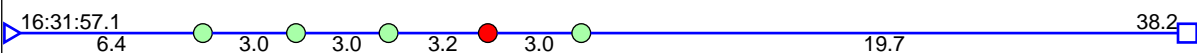
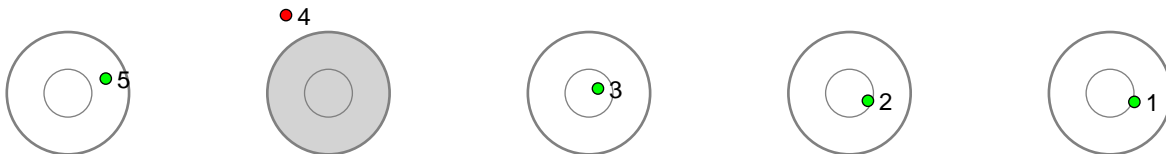

**Disclaimer:**

These results are unofficial since only the final output from the timing system can provide complete and correct competition results. The graphic plot of each series, presents the location of the shots on each of the five targets. Please observe that the accuracy of the plotting has some limitations due to image resolution and/or printer quality.

# 515 Kvelvane Une Christiane Tronerud

Voss Skiskytterlag

Result: 4

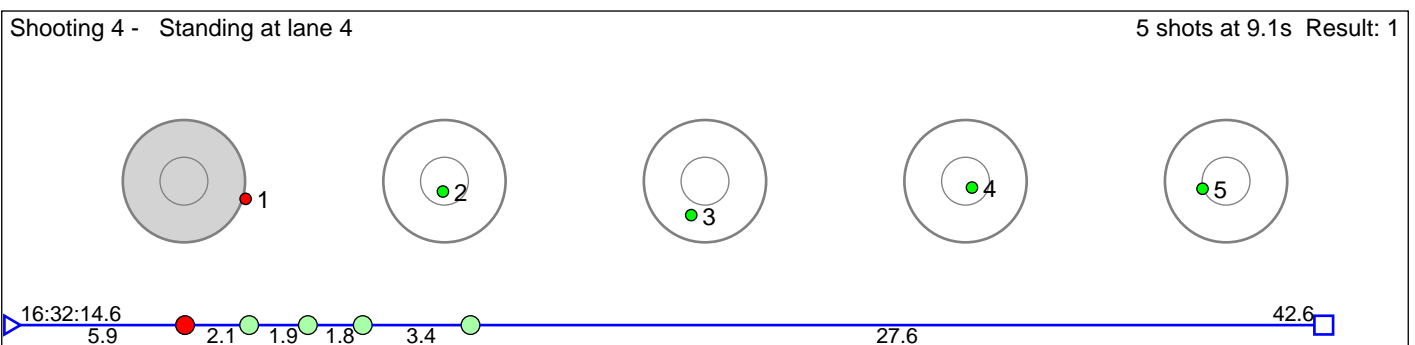
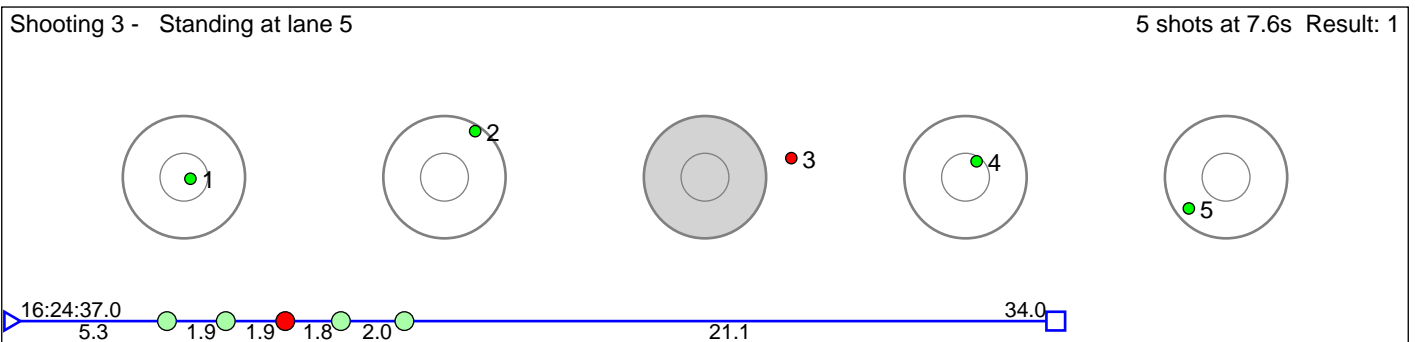
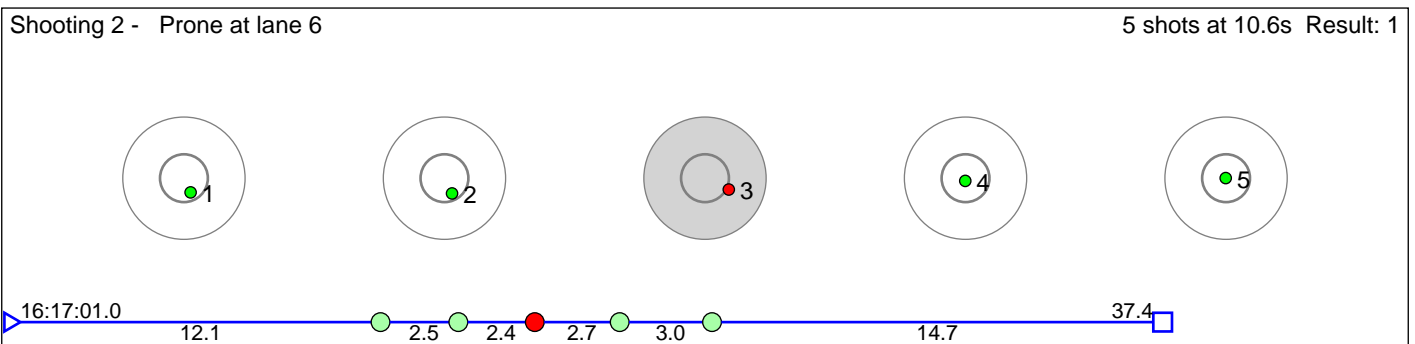
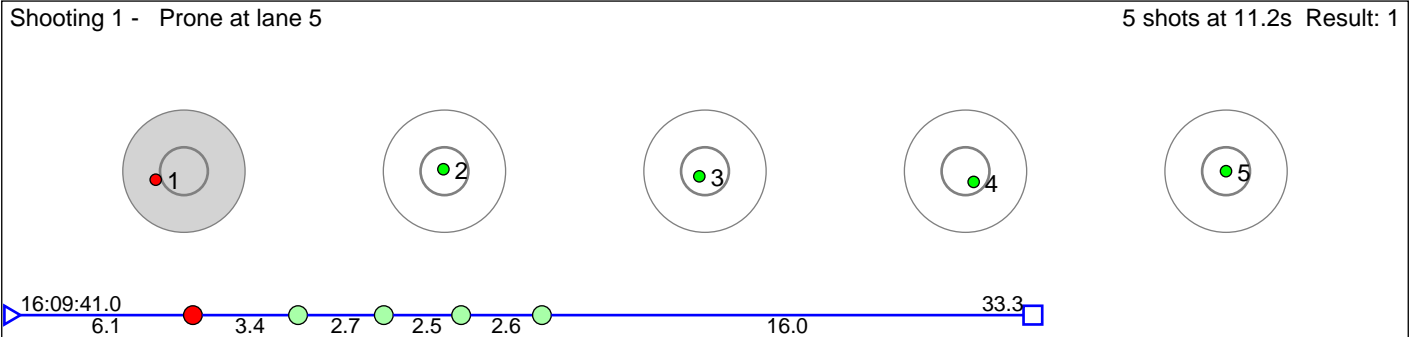

**Disclaimer:**

These results are unofficial since only the final output from the timing system can provide complete and correct competition results. The graphic plot of each series, presents the location of the shots on each of the five targets. Please observe that the accuracy of the plotting has some limitations due to image resolution and/or printer quality.

# 516 Wetterhus Mari

Svene IL

Result: 2

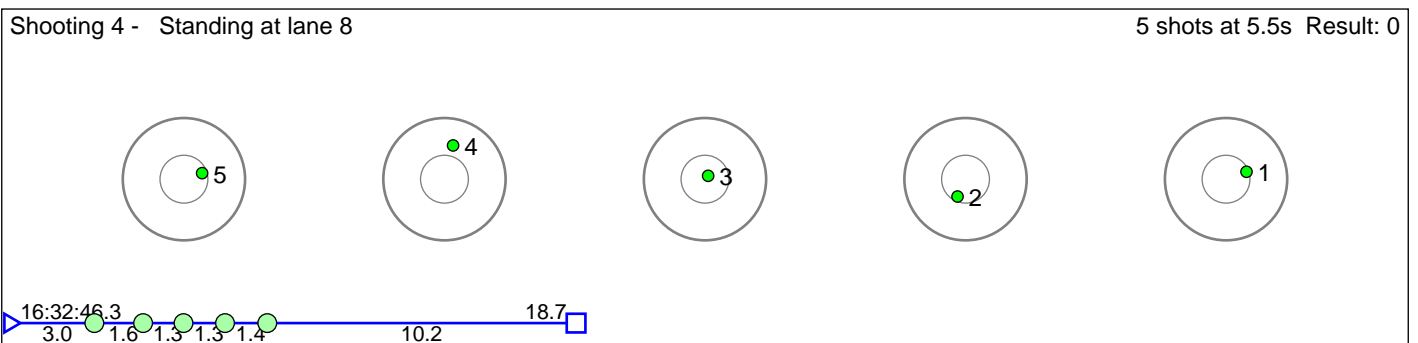
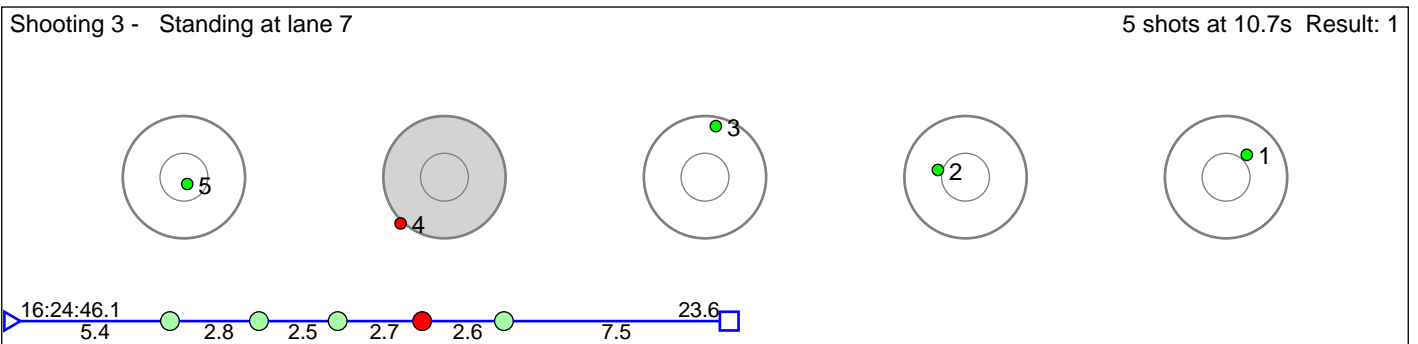
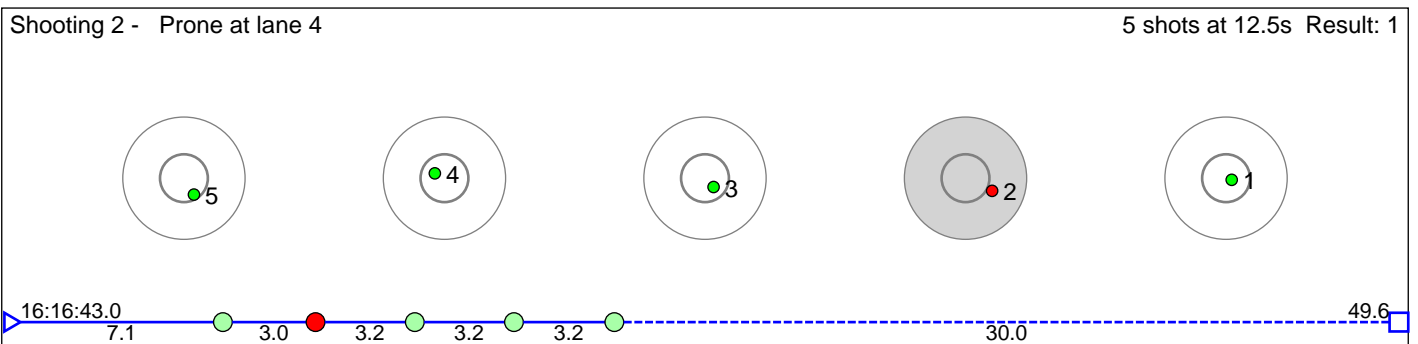
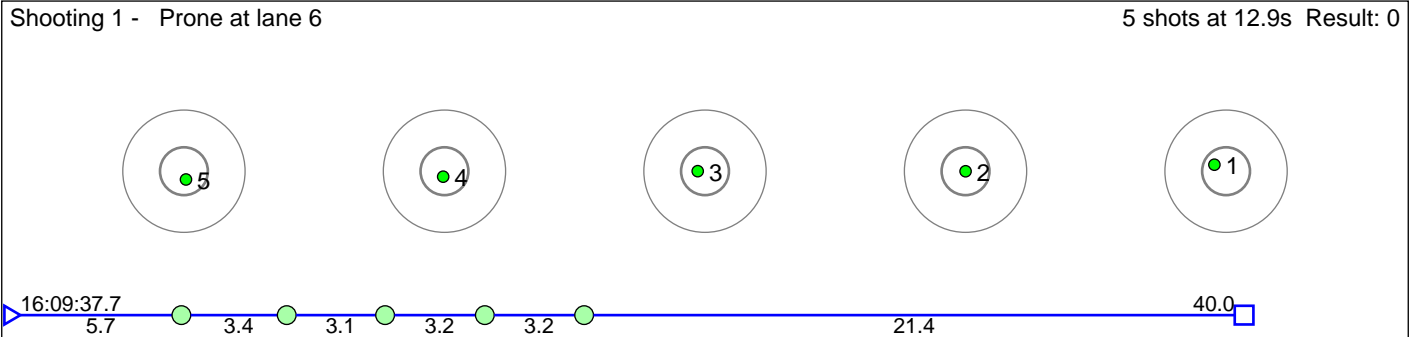

**Disclaimer:**

These results are unofficial since only the final output from the timing system can provide complete and correct competition results. The graphic plot of each series, presents the location of the shots on each of the five targets. Please observe that the accuracy of the plotting has some limitations due to image resolution and/or printer quality.

# 517 Stølen Gunhild Viljugrein

Bærums Skiklub

Result: 1

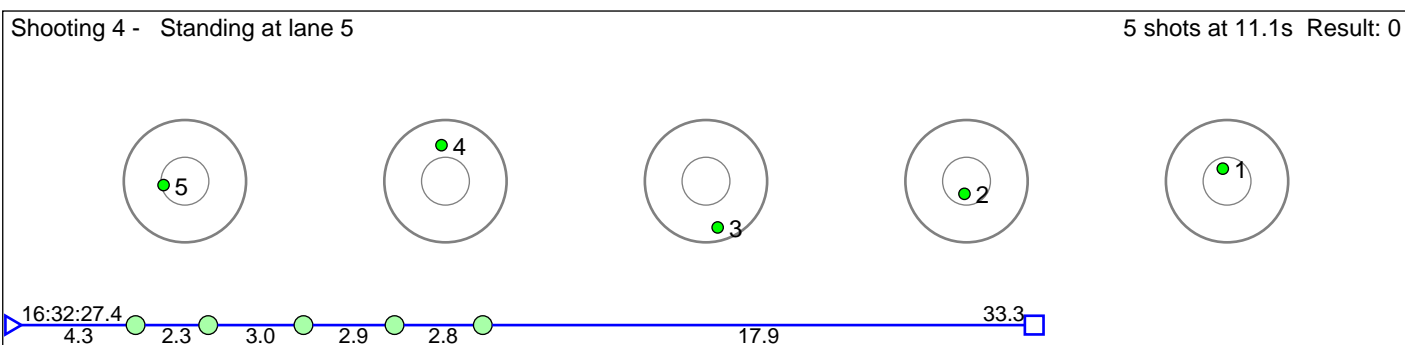
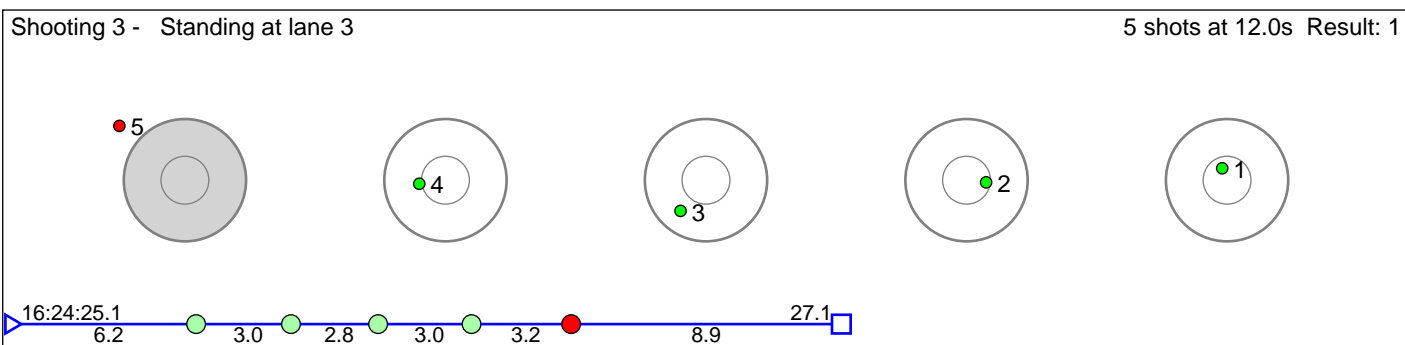
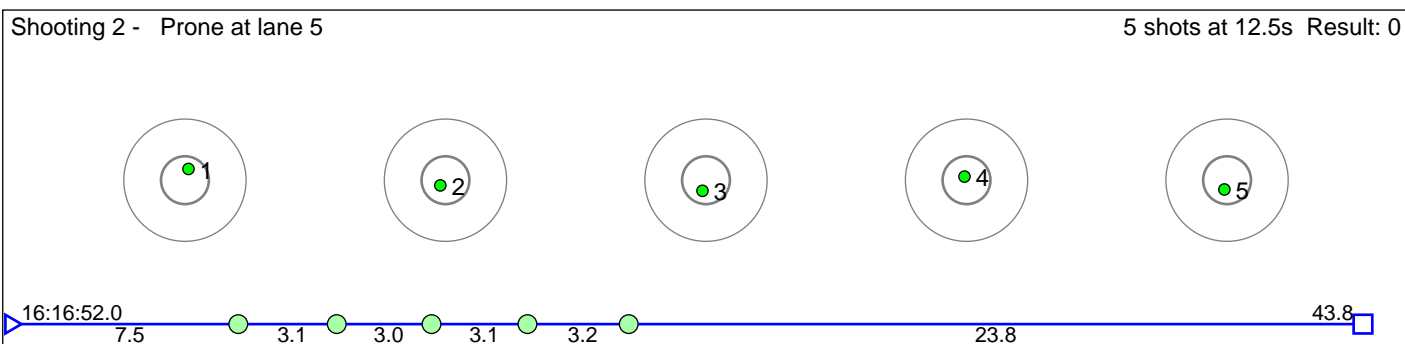
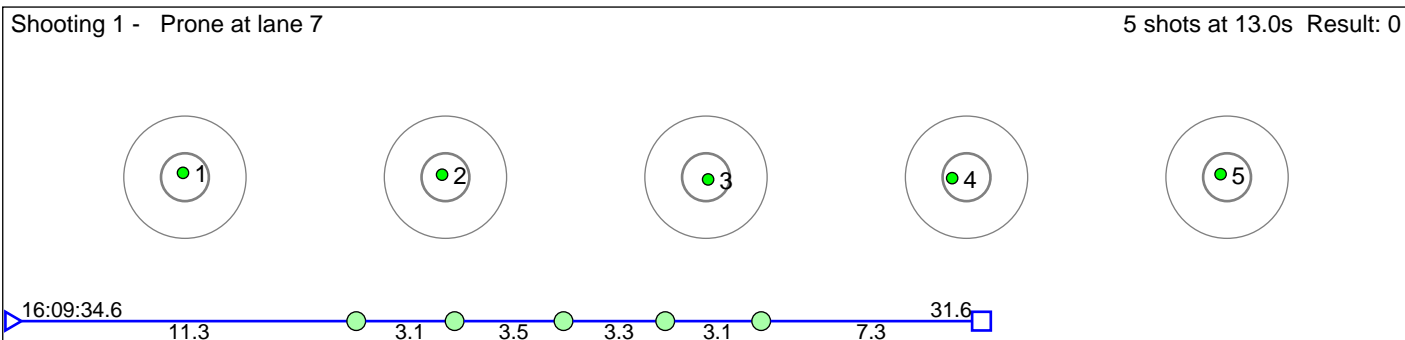

**Disclaimer:**

These results are unofficial since only the final output from the timing system can provide complete and correct competition results. The graphic plot of each series, presents the location of the shots on each of the five targets. Please observe that the accuracy of the plotting has some limitations due to image resolution and/or printer quality.

# 518 Bergtun Malin Auganæs

Kvam Langrenn- og Skiskyttarklubb

Result: 2

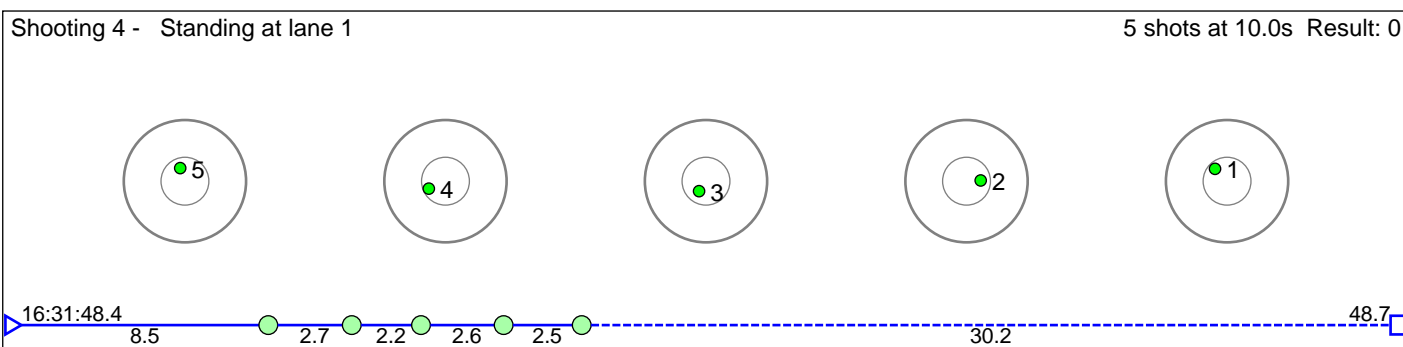
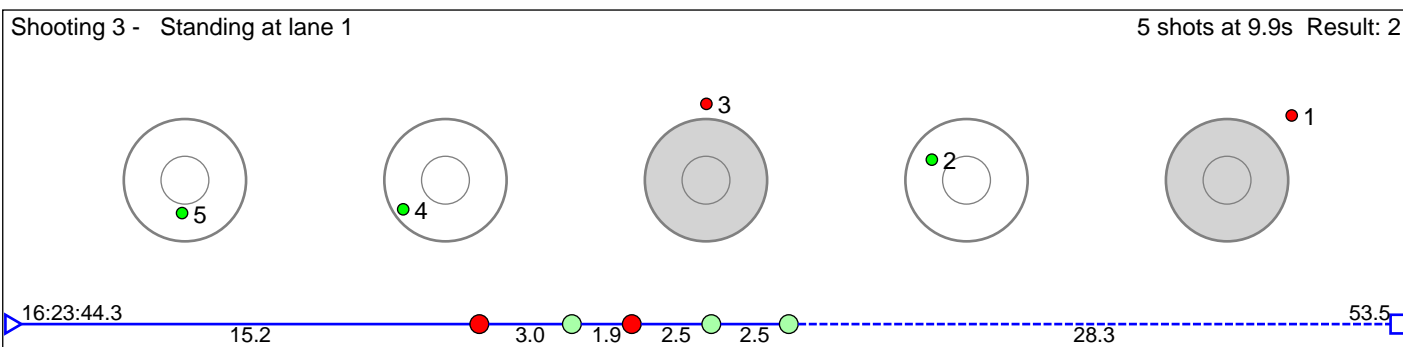
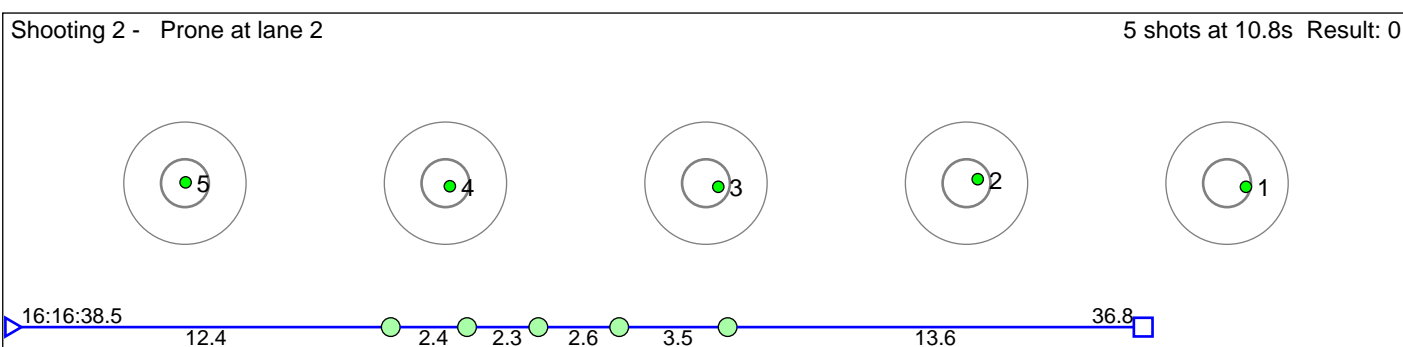
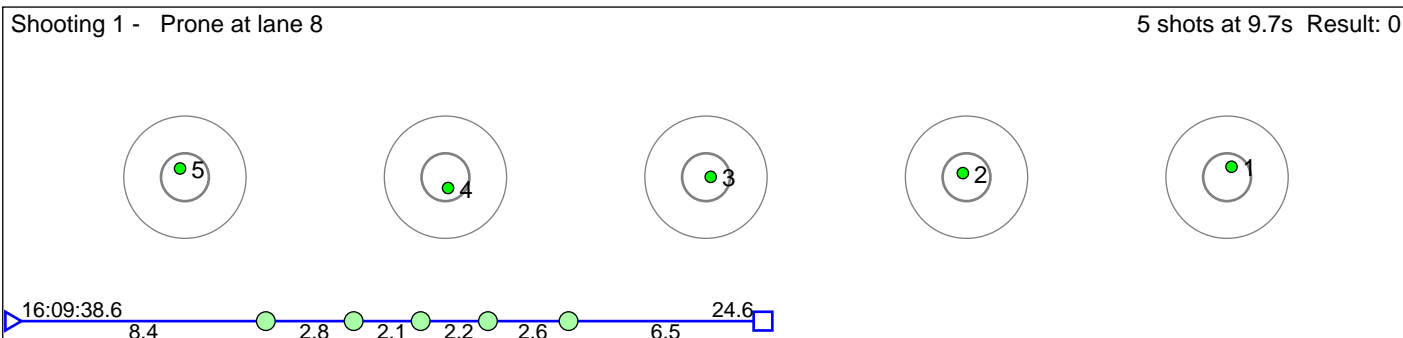

**Disclaimer:**

These results are unofficial since only the final output from the timing system can provide complete and correct competition results. The graphic plot of each series, presents the location of the shots on each of the five targets. Please observe that the accuracy of the plotting has some limitations due to image resolution and/or printer quality.

# 519 Dahl Frida

Steinkjer Skiklubb

Result: 5

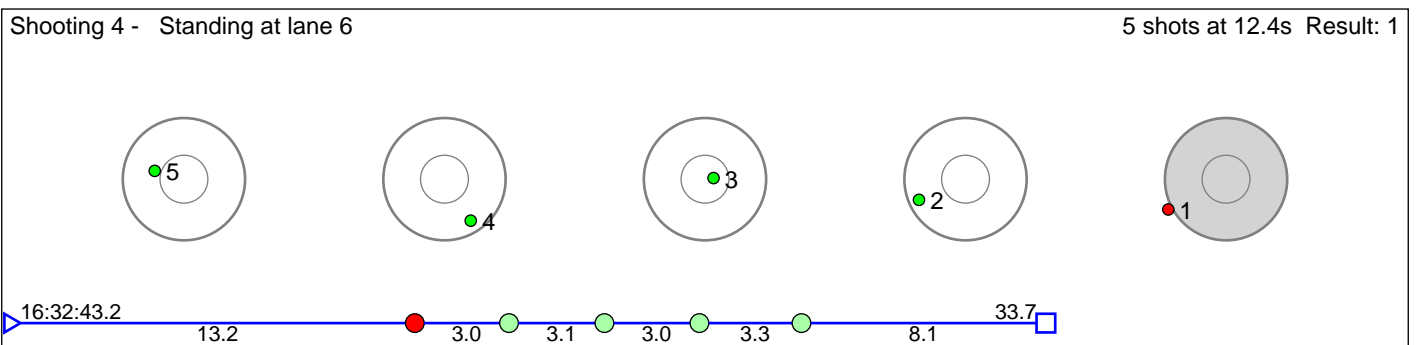
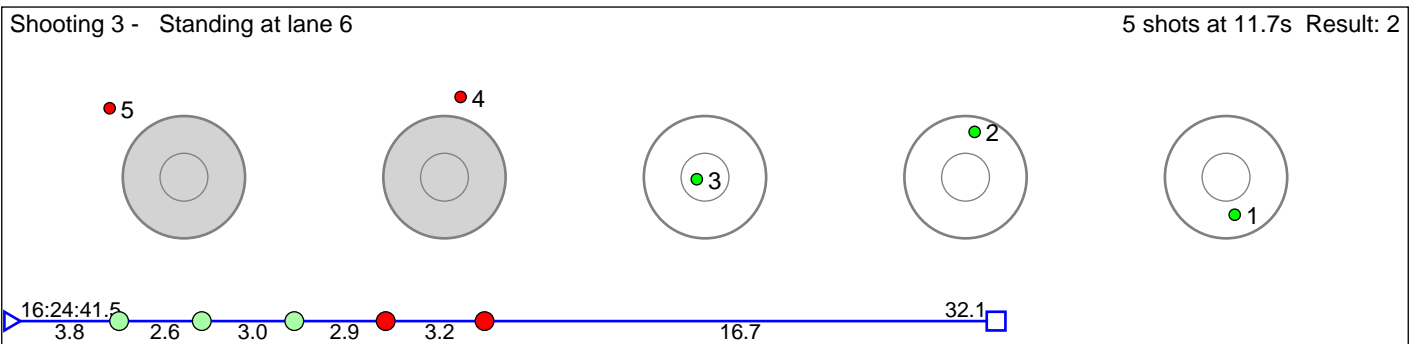
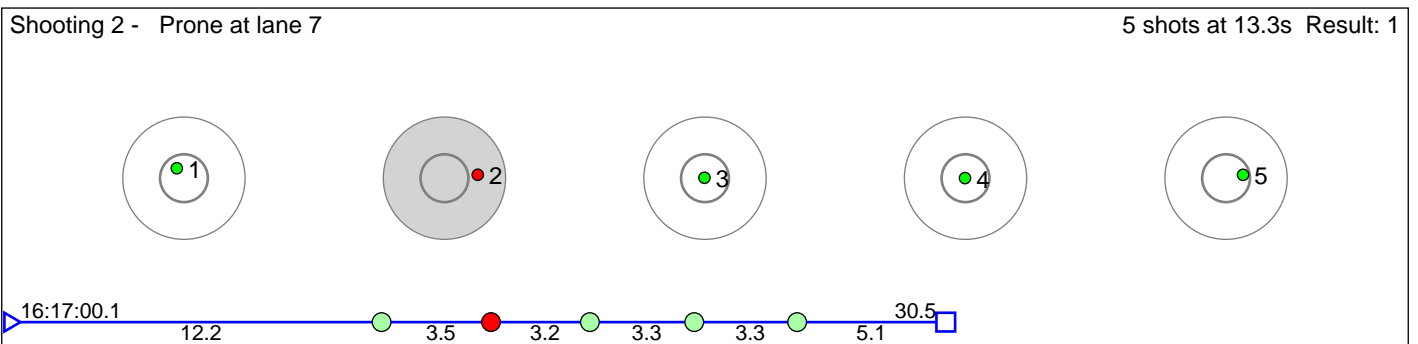
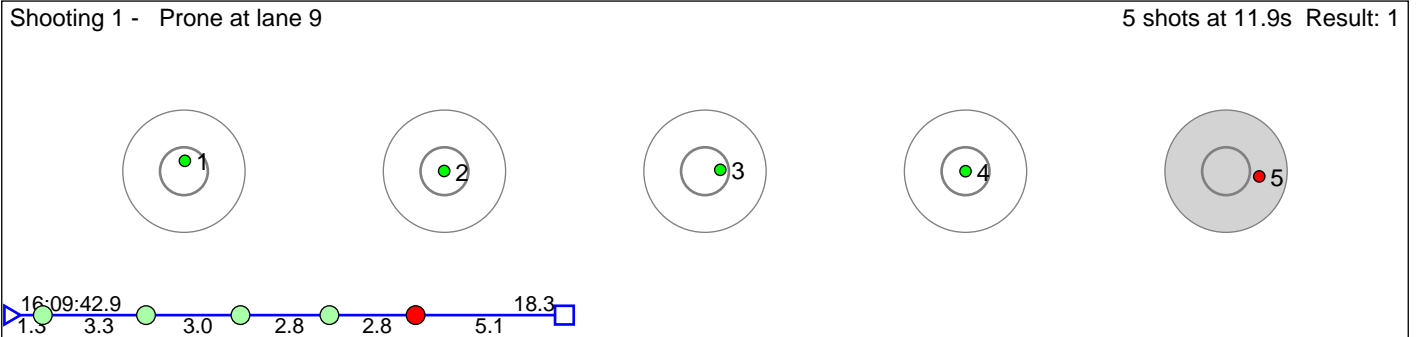



Shooting 5 - Prone at lane 19

5 shots at 13.4s Result: 0

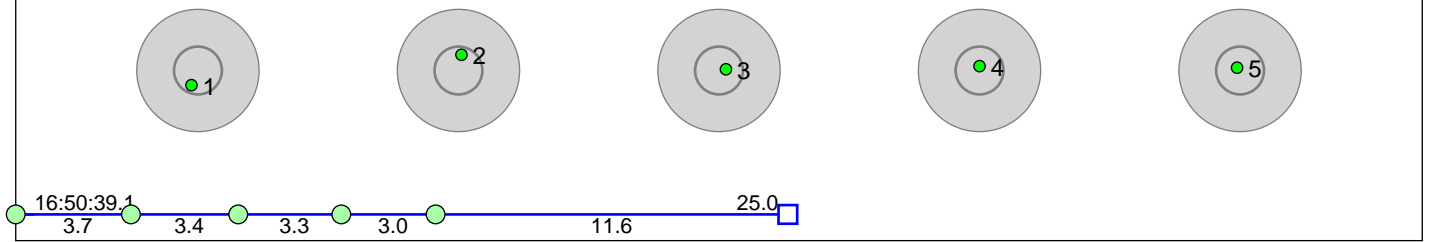

Disclaimer:

These results are unofficial since only the final output from the timing system can provide complete and correct competition results. The graphic plot of each series, presents the location of the shots on each of the five targets. Please observe that the accuracy of the plotting has some limitations due to image resolution and/or printer quality.

# 520 Øygaard Marit

Skrautvål IL

Result: 3

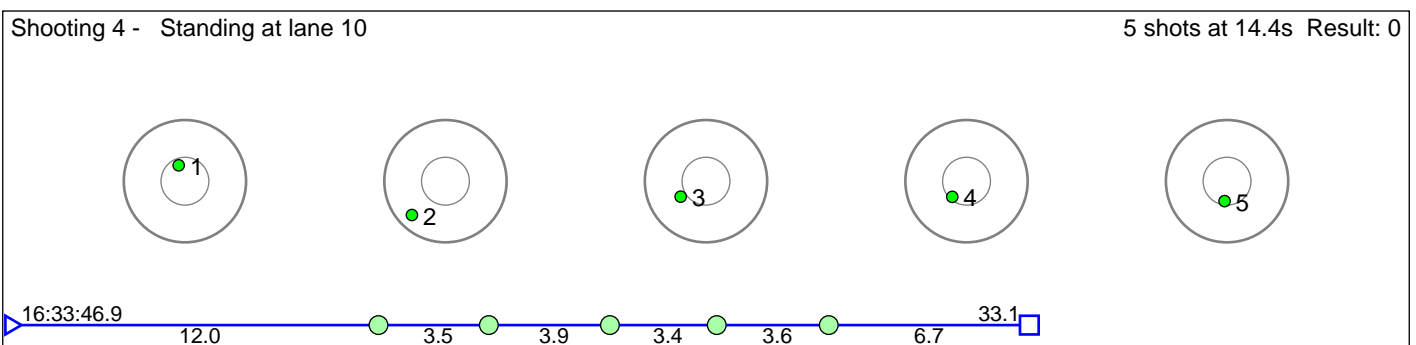
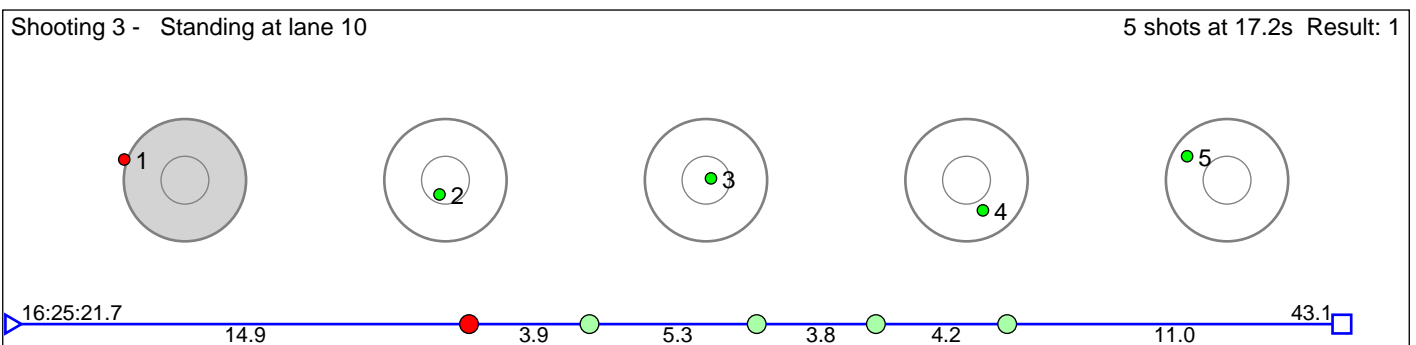
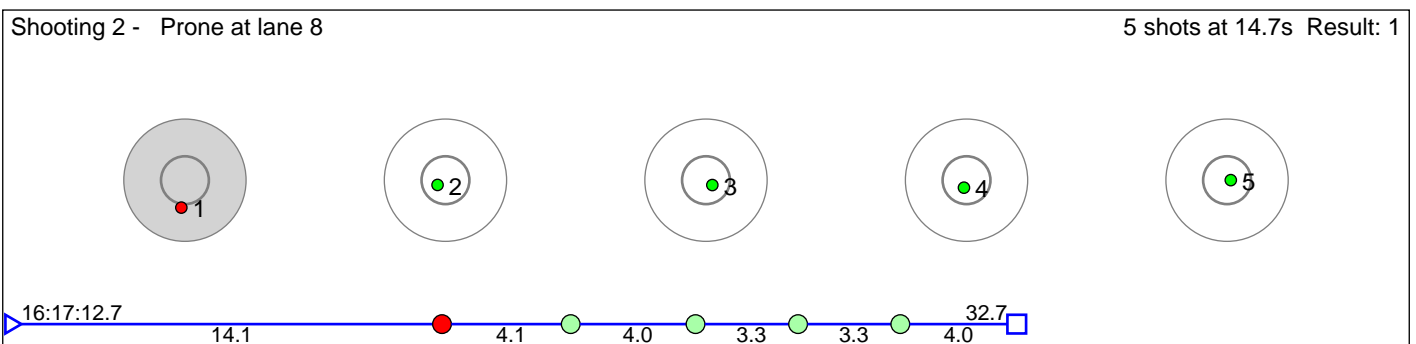
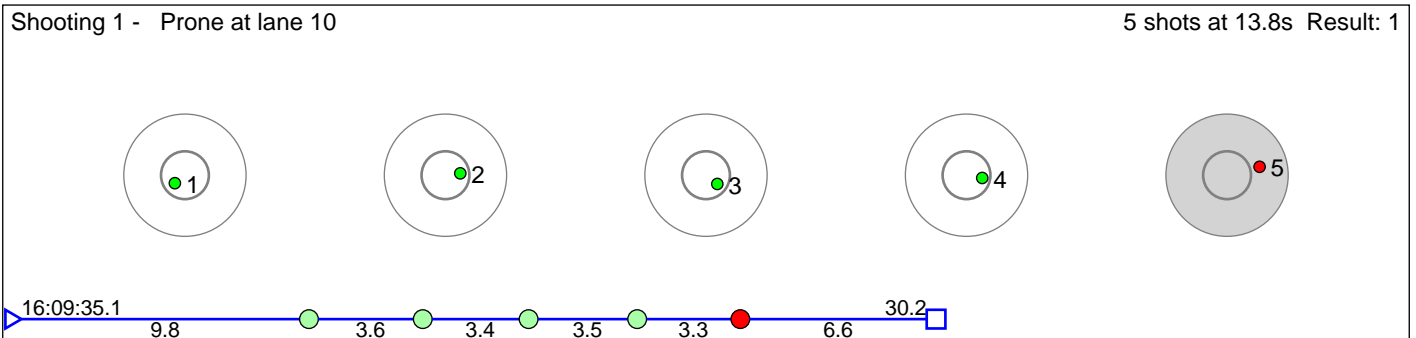

**Disclaimer:**

These results are unofficial since only the final output from the timing system can provide complete and correct competition results. The graphic plot of each series, presents the location of the shots on each of the five targets. Please observe that the accuracy of the plotting has some limitations due to image resolution and/or printer quality.

# 521 Bakken Silje

Leik, IL

Result: 0

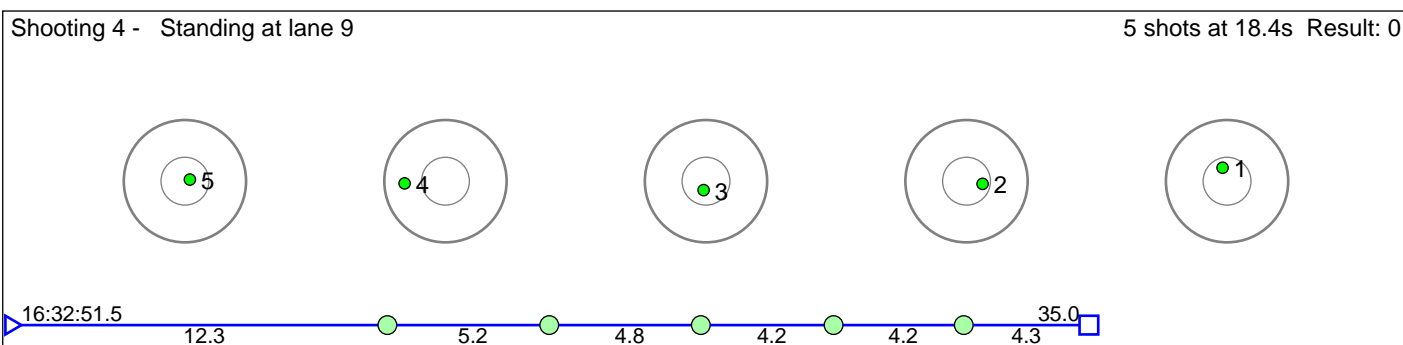
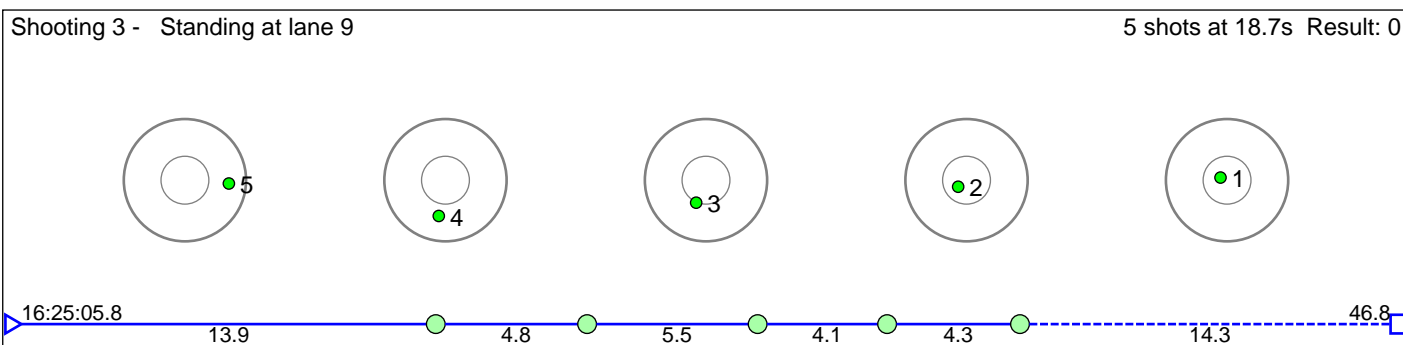
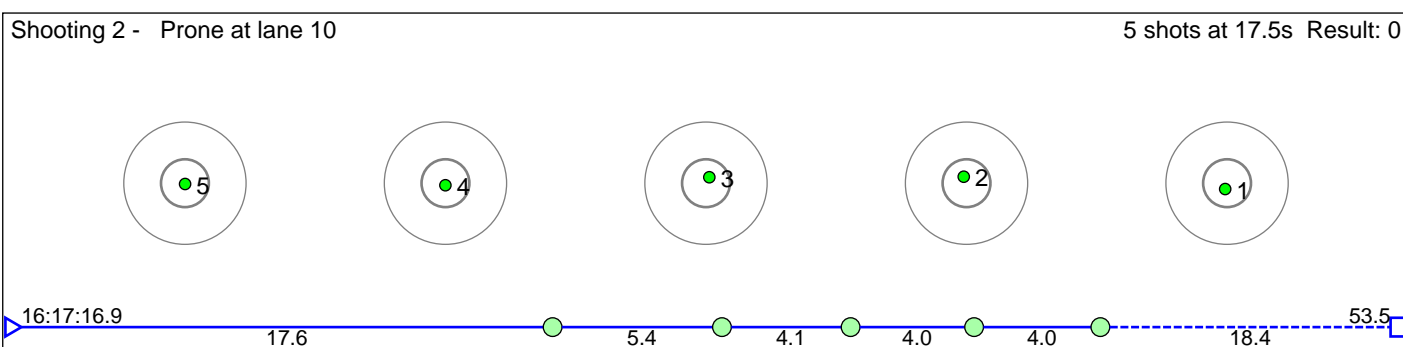
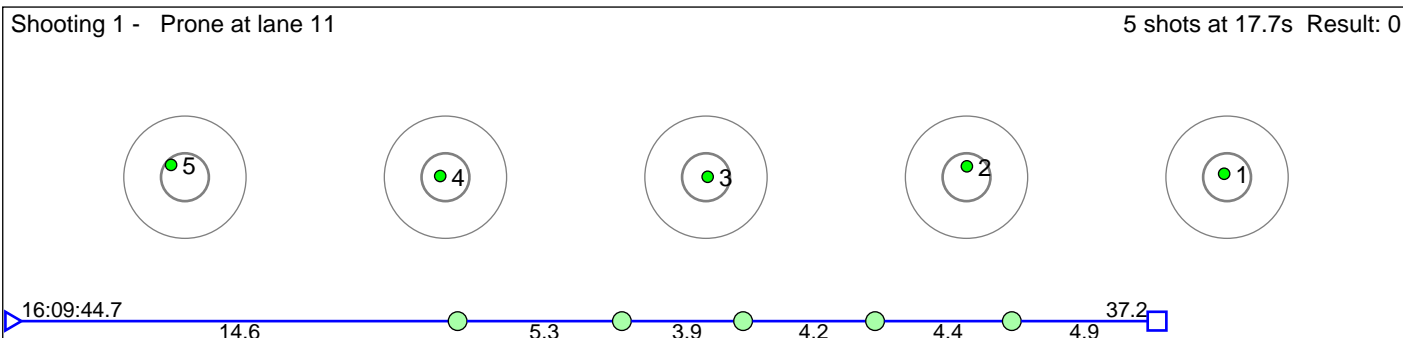

**Disclaimer:**

These results are unofficial since only the final output from the timing system can provide complete and correct competition results. The graphic plot of each series, presents the location of the shots on each of the five targets. Please observe that the accuracy of the plotting has some limitations due to image resolution and/or printer quality.

# 523 Husøy Ingrid Stølan

Molde og Omegn IF

Result: 7

Shooting 1 - Prone at lane 13 5 shots at 11.9s Result: 1

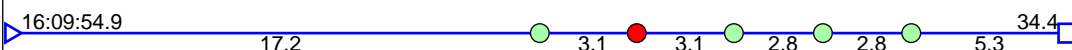
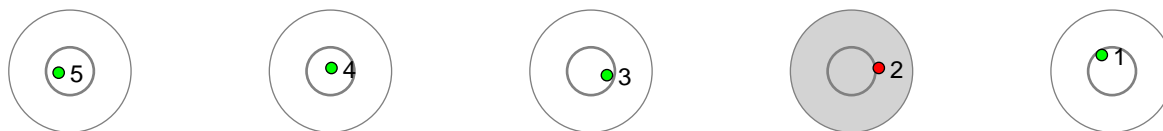

Shooting 2 - Prone at lane 13 5 shots at 11.2s Result: 1

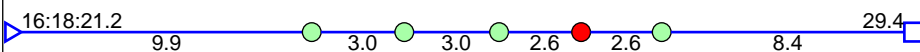
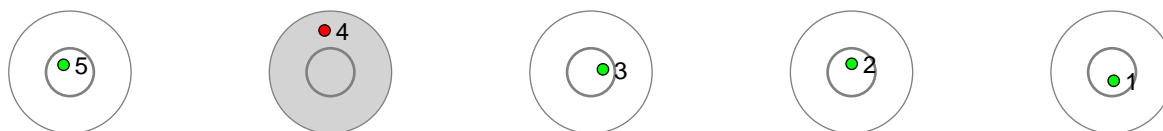

Shooting 3 - Standing at lane 14 5 shots at 22.6s Result: 0

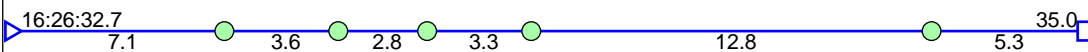
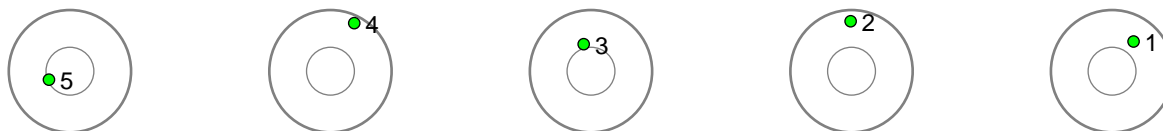

**Disclaimer:**

These results are unofficial since only the final output from the timing system can provide complete and correct competition results. The graphic plot of each series, presents the location of the shots on each of the five targets. Please observe that the accuracy of the plotting has some limitations due to image resolution and/or printer quality.

# 524 Skotland Vilde Aurora Gusevik

Try, Idrettslaget

Result: 7

Shooting 1 - Prone at lane 14 5 shots at 13.3s Result: 2

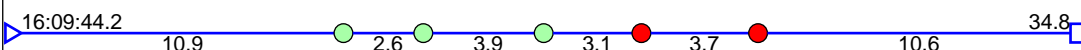
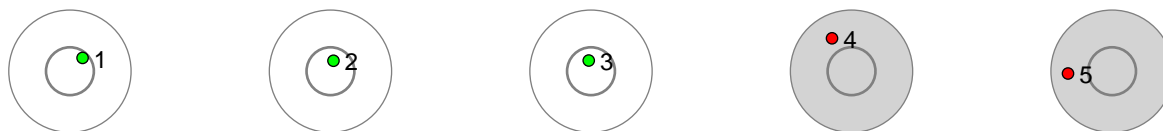

Shooting 2 - Prone at lane 15 5 shots at 10.3s Result: 0

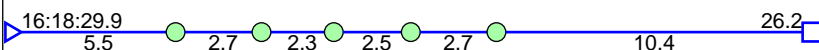
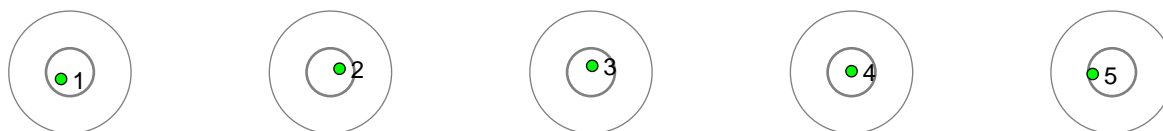

Shooting 3 - Standing at lane 11 5 shots at 8.1s Result: 3

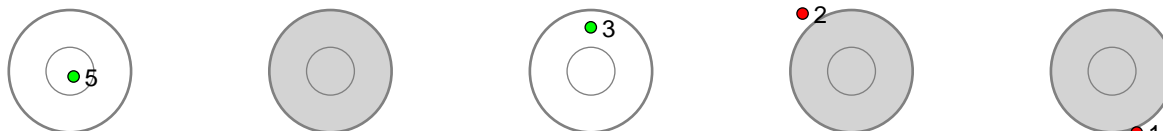

Shooting 4 - Standing at lane 14 5 shots at 12.2s Result: 2

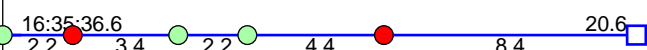
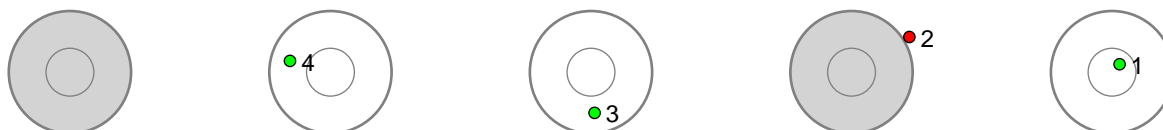

**Disclaimer:**

These results are unofficial since only the final output from the timing system can provide complete and correct competition results. The graphic plot of each series, presents the location of the shots on each of the five targets. Please observe that the accuracy of the plotting has some limitations due to image resolution and/or printer quality.

# 525 Bergmann Kristina Hipolan

Drangedal Idrettslag

Result: 5

Shooting 1 - Prone at lane 15 5 shots at 11.5s Result: 1

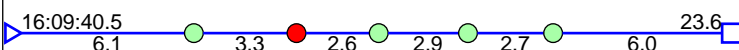
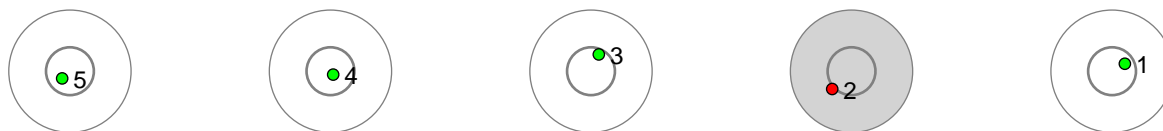

Shooting 2 - Prone at lane 11 5 shots at 13.6s Result: 3

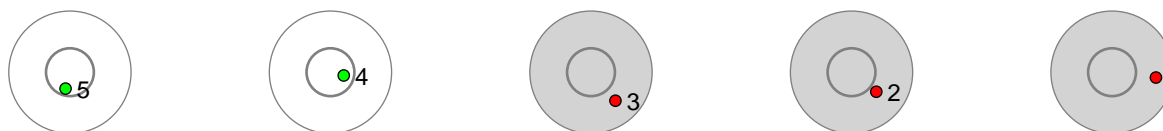

Shooting 3 - Standing at lane 13 5 shots at 10.6s Result: 1

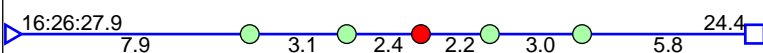
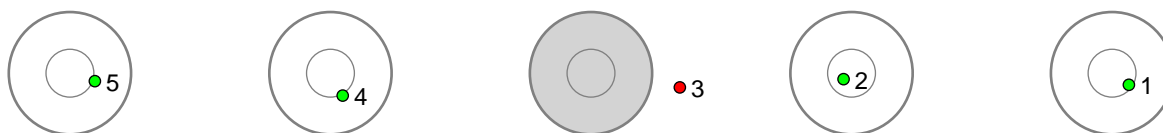

Shooting 4 - Standing at lane 11 5 shots at 9.3s Result: 0

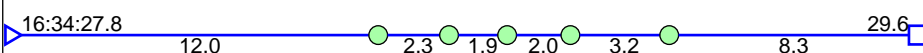
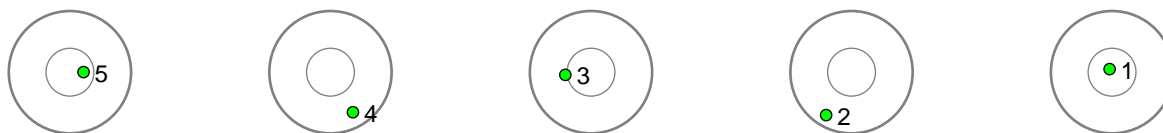

**Disclaimer:**

These results are unofficial since only the final output from the timing system can provide complete and correct competition results. The graphic plot of each series, presents the location of the shots on each of the five targets. Please observe that the accuracy of the plotting has some limitations due to image resolution and/or printer quality.

# 526 Hatling Andrine Øverland

Fana IL

Result: 10

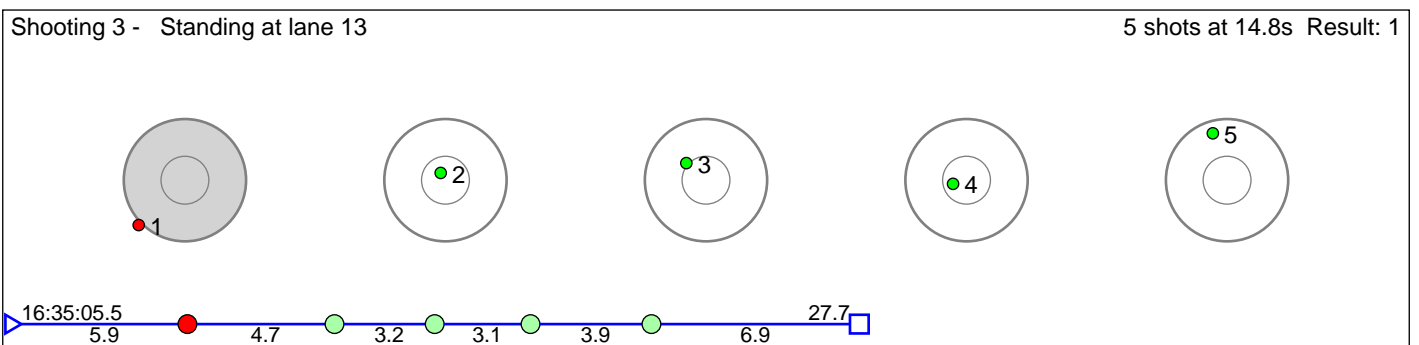
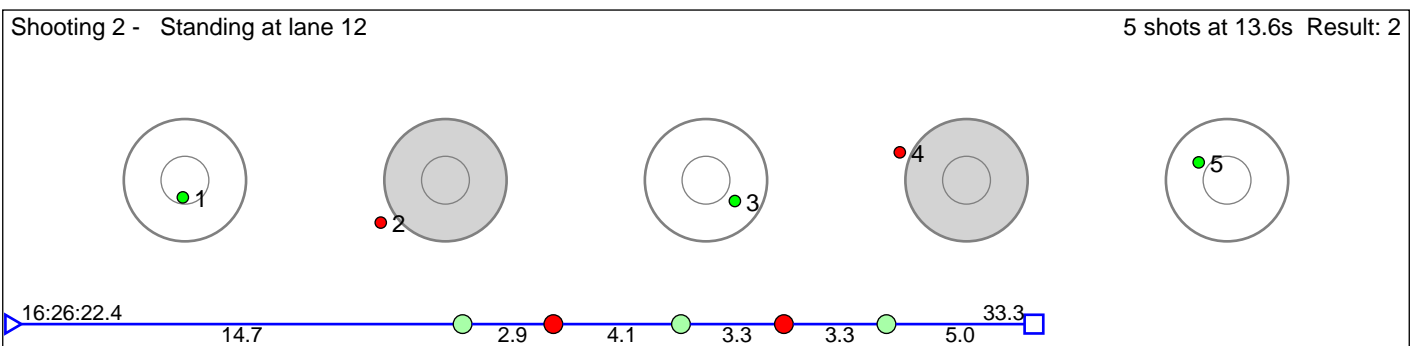
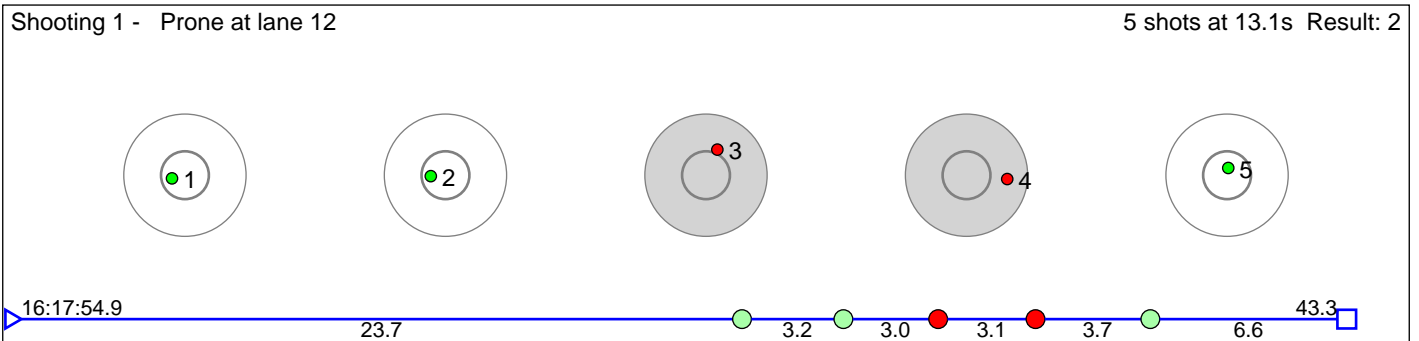

**Disclaimer:**

These results are unofficial since only the final output from the timing system can provide complete and correct competition results. The graphic plot of each series, presents the location of the shots on each of the five targets. Please observe that the accuracy of the plotting has some limitations due to image resolution and/or printer quality.

# 528 Angell Tori

Odda IL

Result: 10

Shooting 1 - Prone at lane 18 5 shots at 13.7s Result: 2

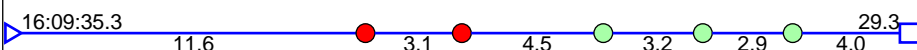
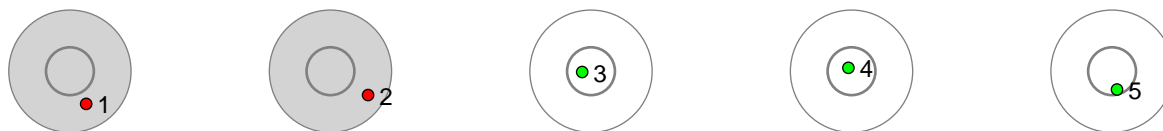

Shooting 2 - Prone at lane 14 5 shots at 11.8s Result: 2

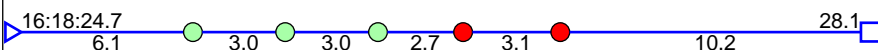
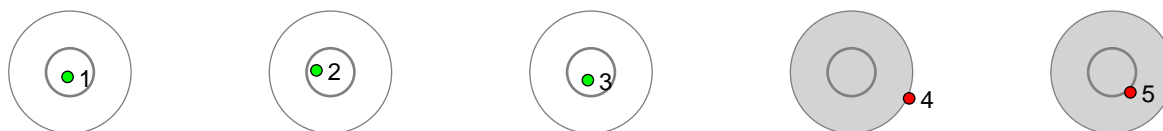

Shooting 3 - Standing at lane 15 5 shots at 12.3s Result: 2

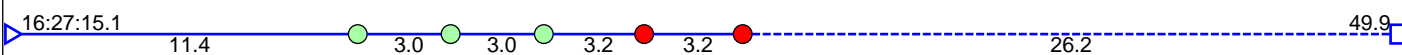
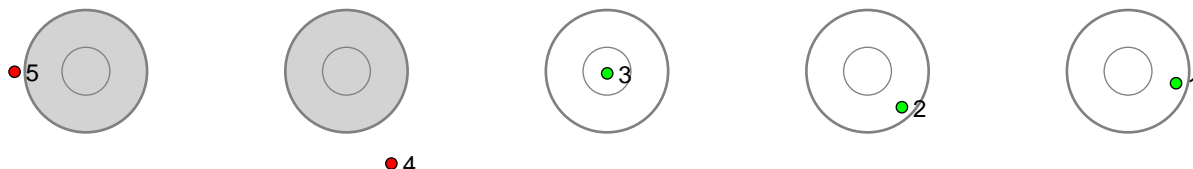

Shooting 4 - Standing at lane 15 5 shots at 13.3s Result: 4

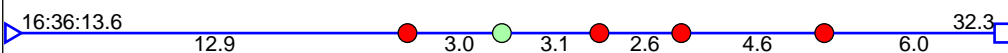
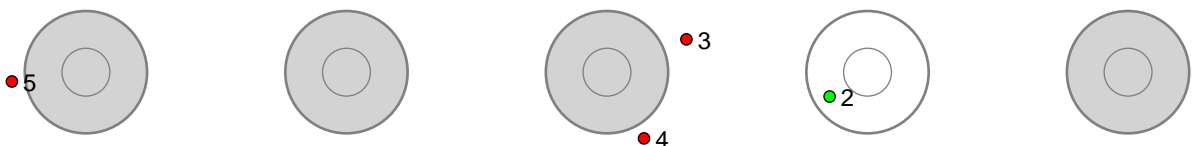

**Disclaimer:**

These results are unofficial since only the final output from the timing system can provide complete and correct competition results. The graphic plot of each series, presents the location of the shots on each of the five targets. Please observe that the accuracy of the plotting has some limitations due to image resolution and/or printer quality.



# 541 Jorde Sindre Fjellheim

Asker Skiklubb

Result: 6

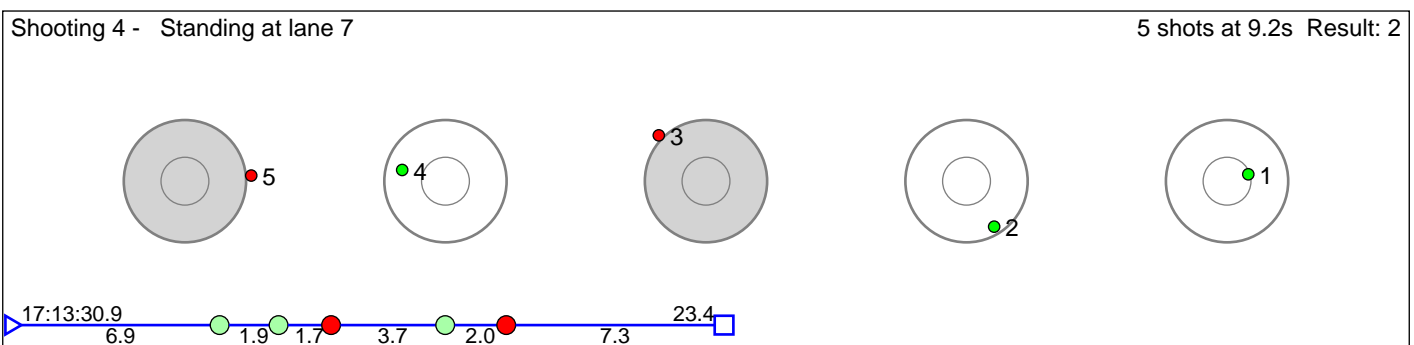
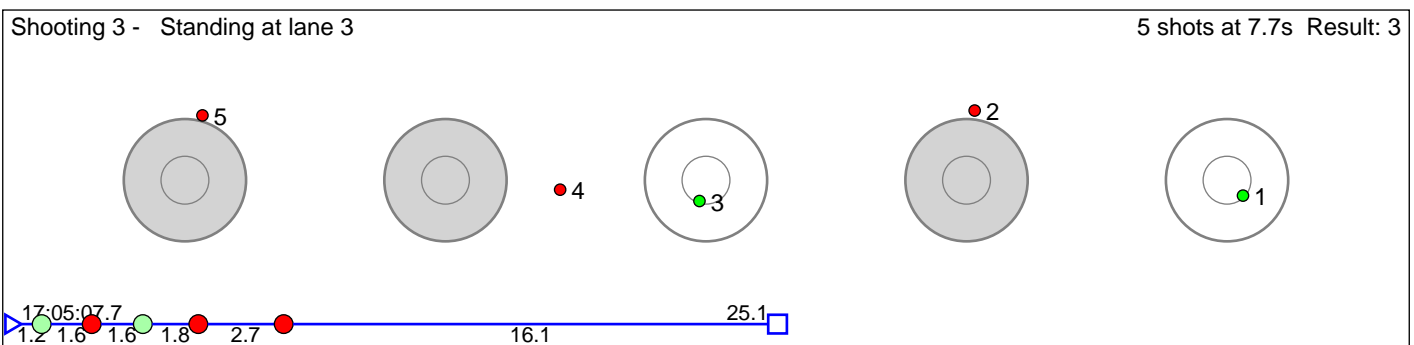
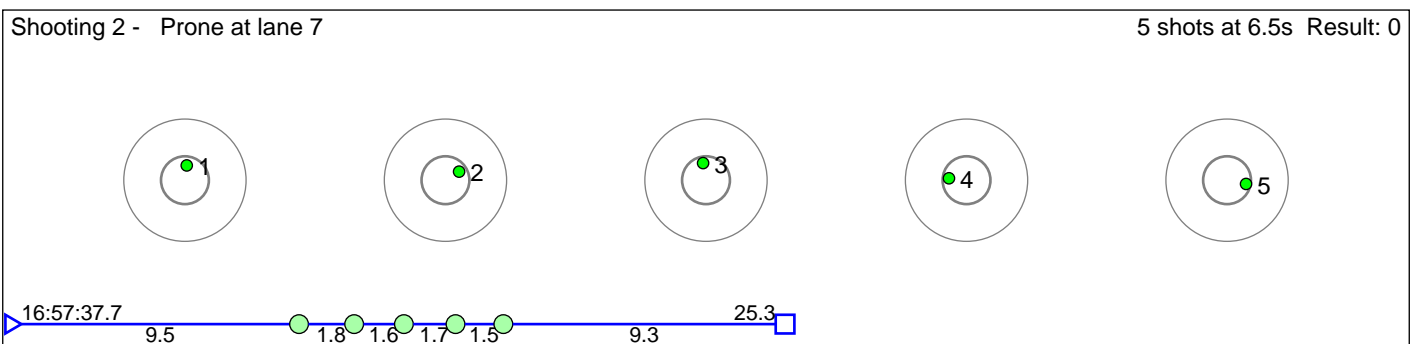
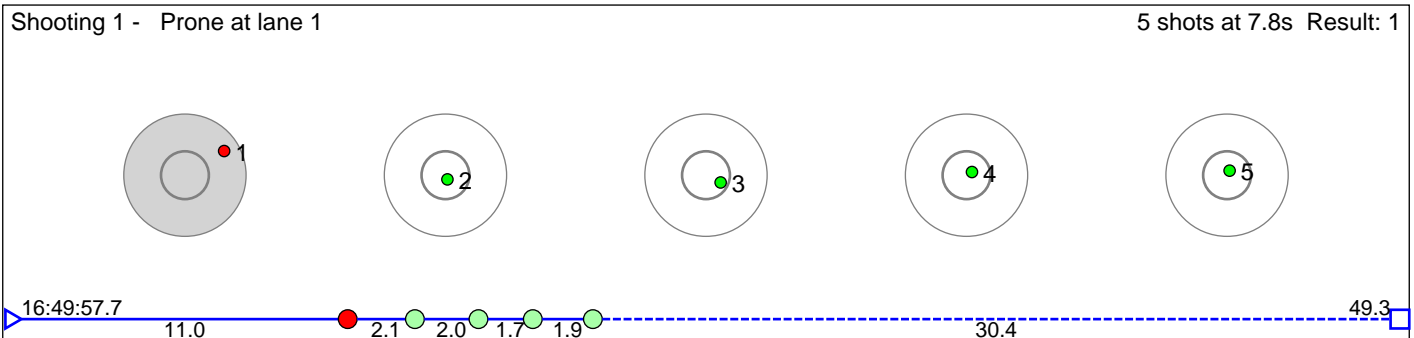

**Disclaimer:**

These results are unofficial since only the final output from the timing system can provide complete and correct competition results. The graphic plot of each series, presents the location of the shots on each of the five targets. Please observe that the accuracy of the plotting has some limitations due to image resolution and/or printer quality.

# 542 Femsteinevik Martin

Hålandsdal IL

Result: 3

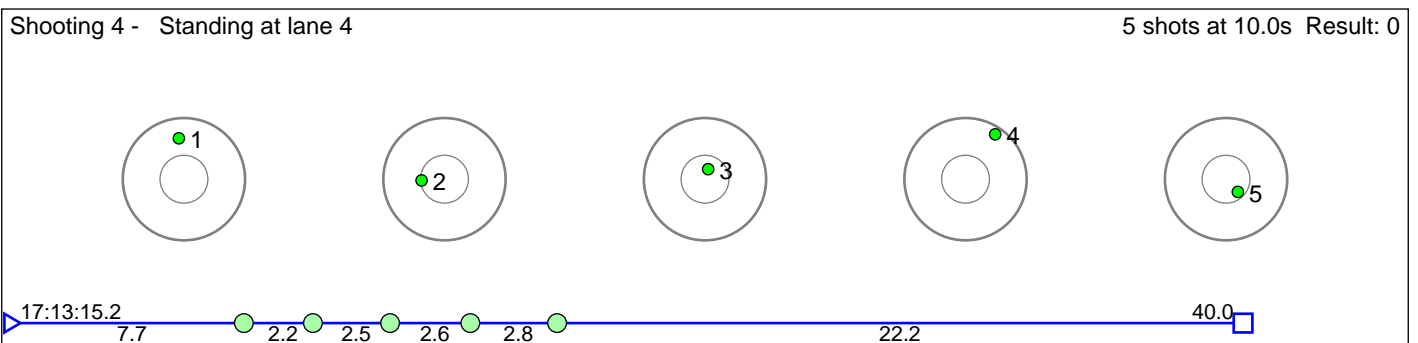
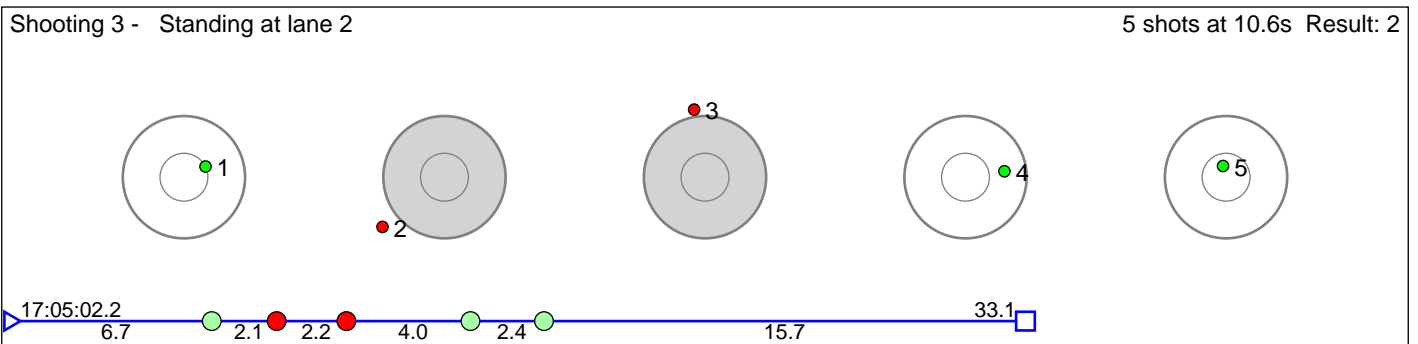
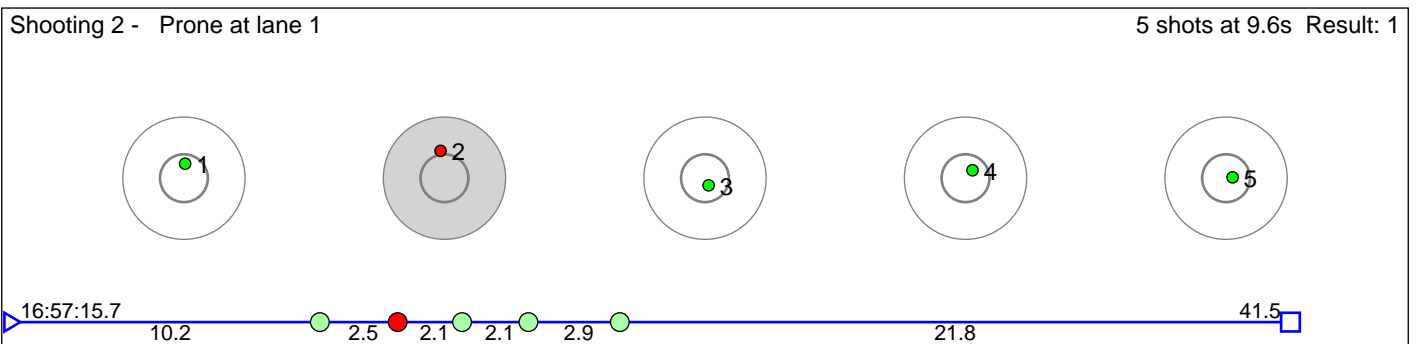
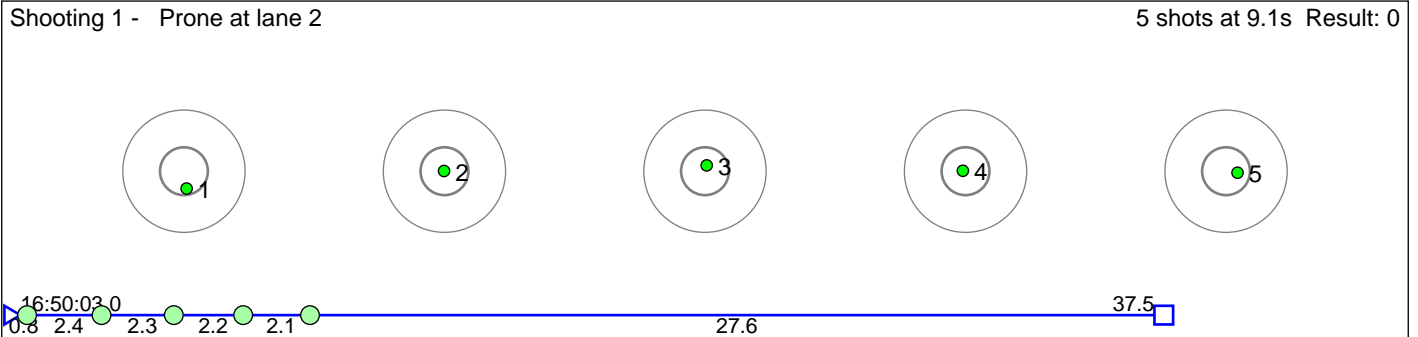

**Disclaimer:**

These results are unofficial since only the final output from the timing system can provide complete and correct competition results. The graphic plot of each series, presents the location of the shots on each of the five targets. Please observe that the accuracy of the plotting has some limitations due to image resolution and/or printer quality.

# 543 Sørum Vebjørn

Søndre Ål Sportsklubb

Result: 5

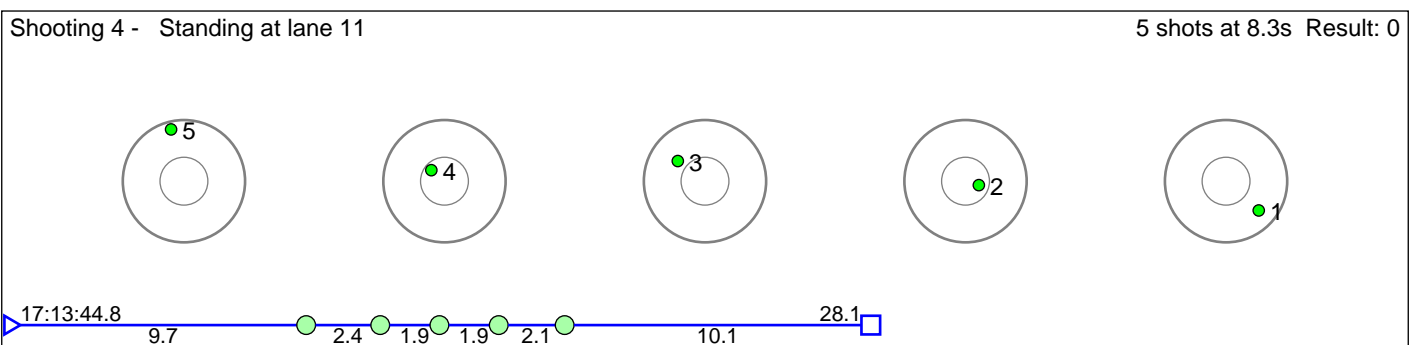
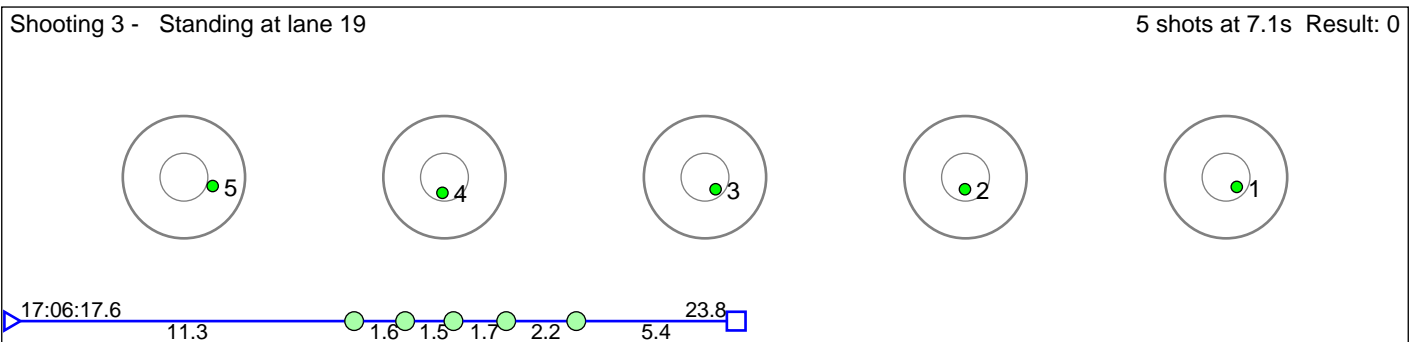
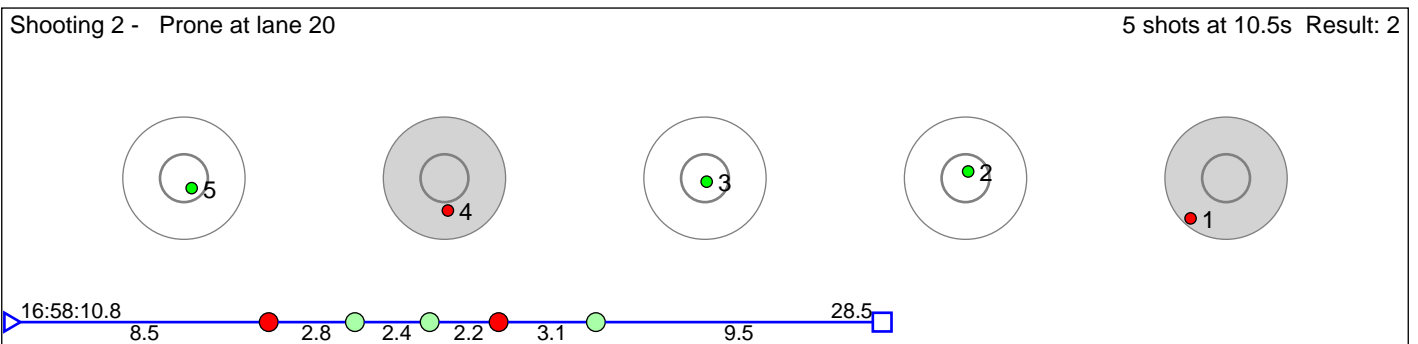
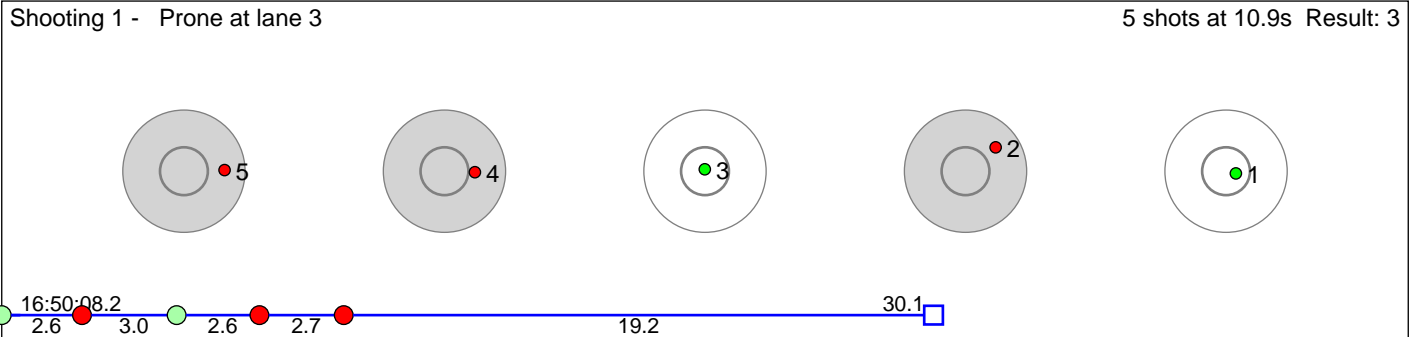

**Disclaimer:**

These results are unofficial since only the final output from the timing system can provide complete and correct competition results. The graphic plot of each series, presents the location of the shots on each of the five targets. Please observe that the accuracy of the plotting has some limitations due to image resolution and/or printer quality.

# 544 Krogsæter Jørgen Brendengen

Ullensaker Skiklubb

Result: 3

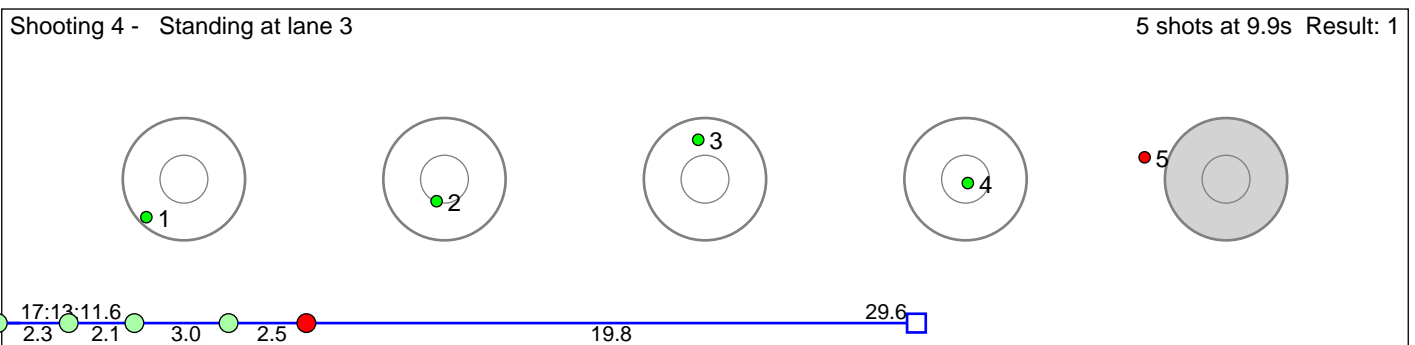
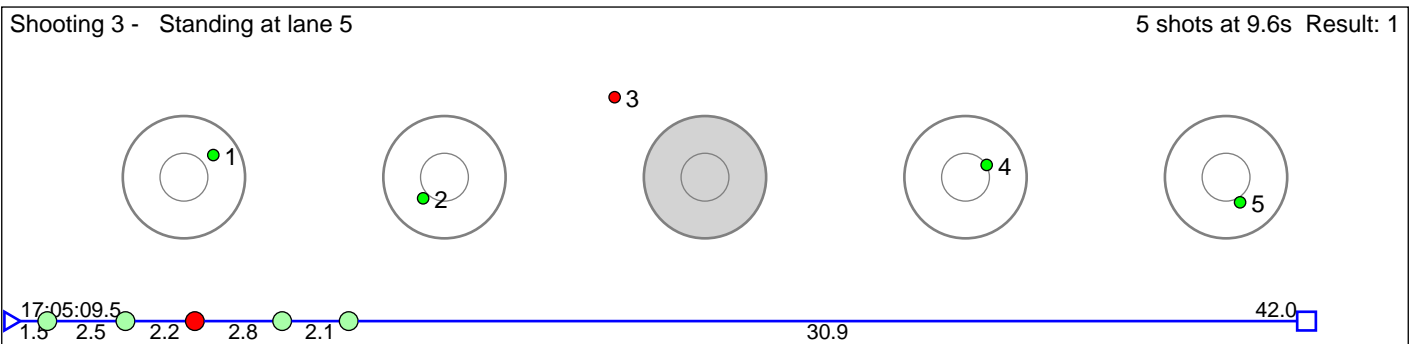
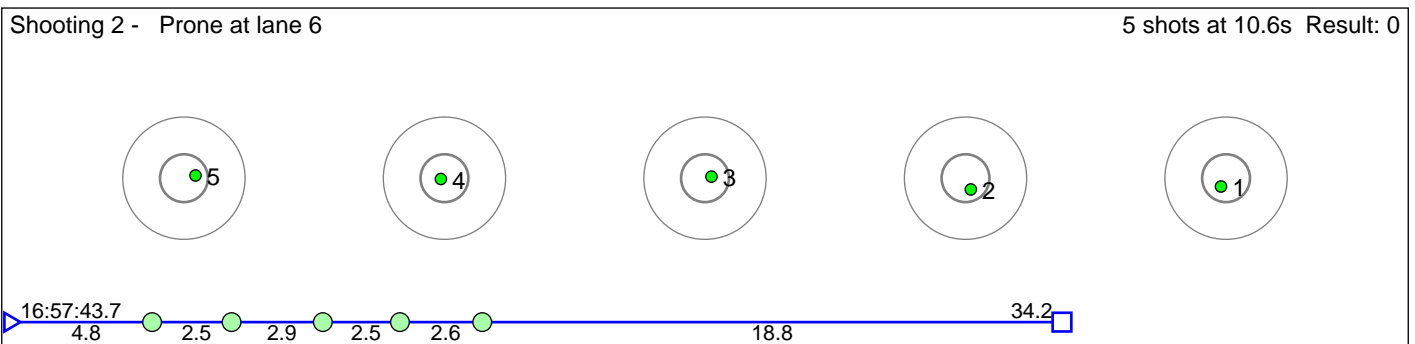
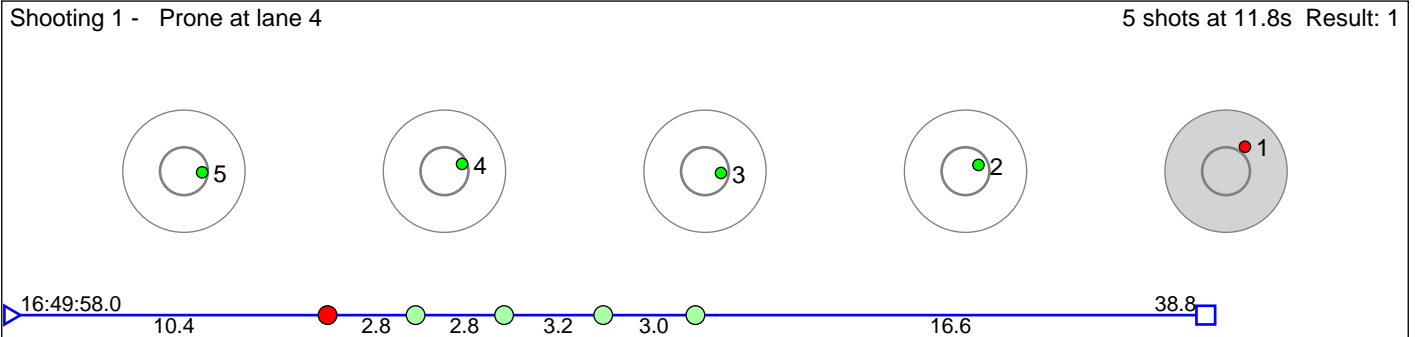

**Disclaimer:**

These results are unofficial since only the final output from the timing system can provide complete and correct competition results. The graphic plot of each series, presents the location of the shots on each of the five targets. Please observe that the accuracy of the plotting has some limitations due to image resolution and/or printer quality.

# 545 Botn Johan-Olav Smørdal

Stårheim IL

Result: 7

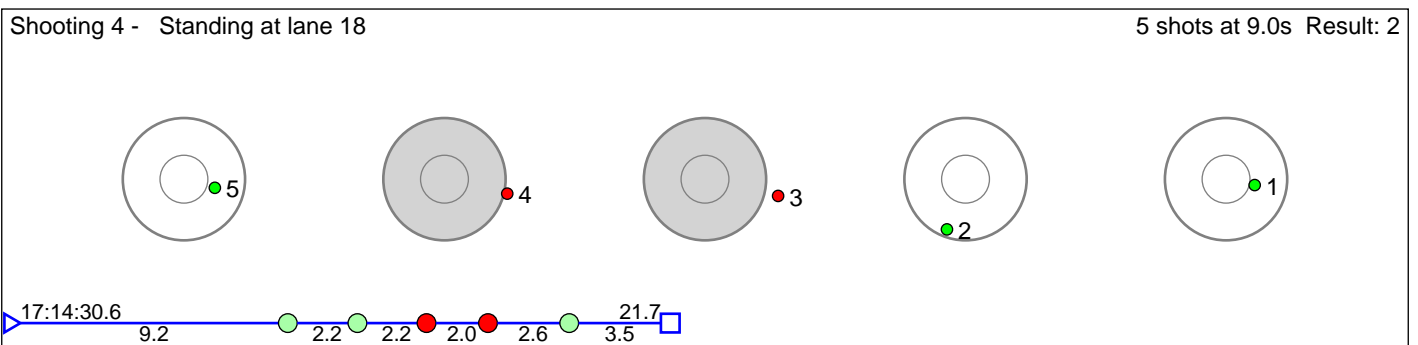
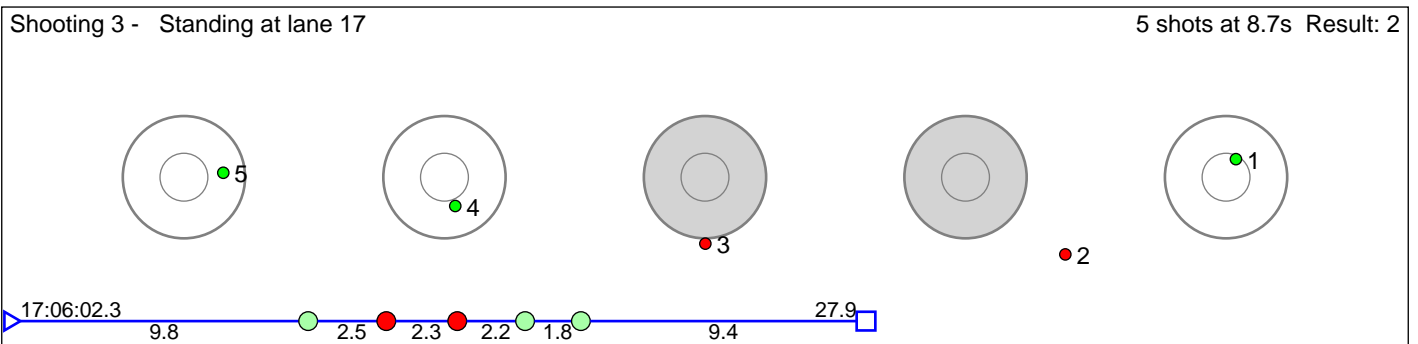
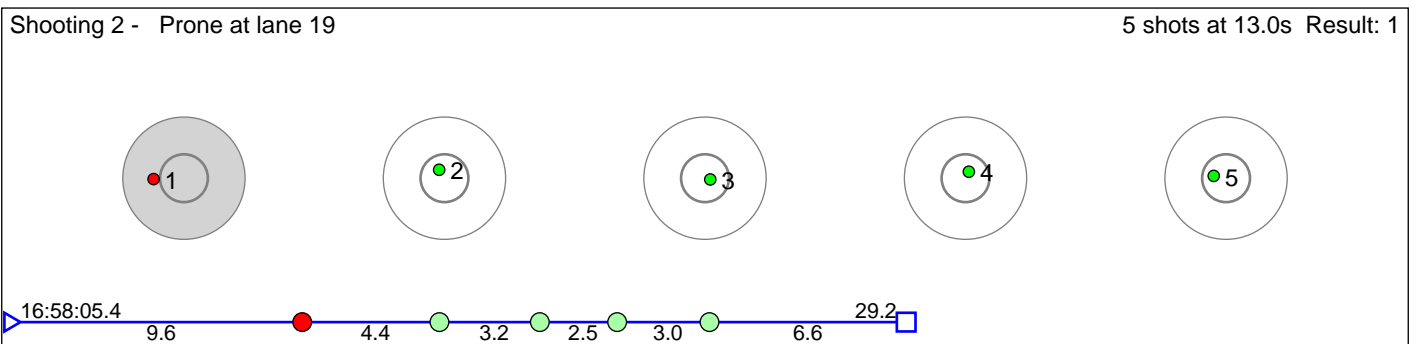
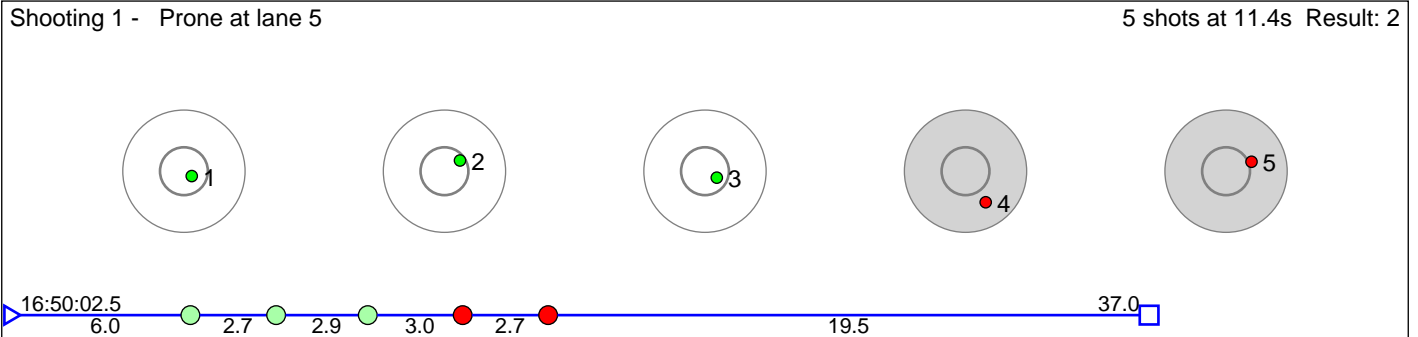

**Disclaimer:**

These results are unofficial since only the final output from the timing system can provide complete and correct competition results. The graphic plot of each series, presents the location of the shots on each of the five targets. Please observe that the accuracy of the plotting has some limitations due to image resolution and/or printer quality.

# 546 Bucher-Johannessen Fredrik

Try, Idrettslaget

Result: 5

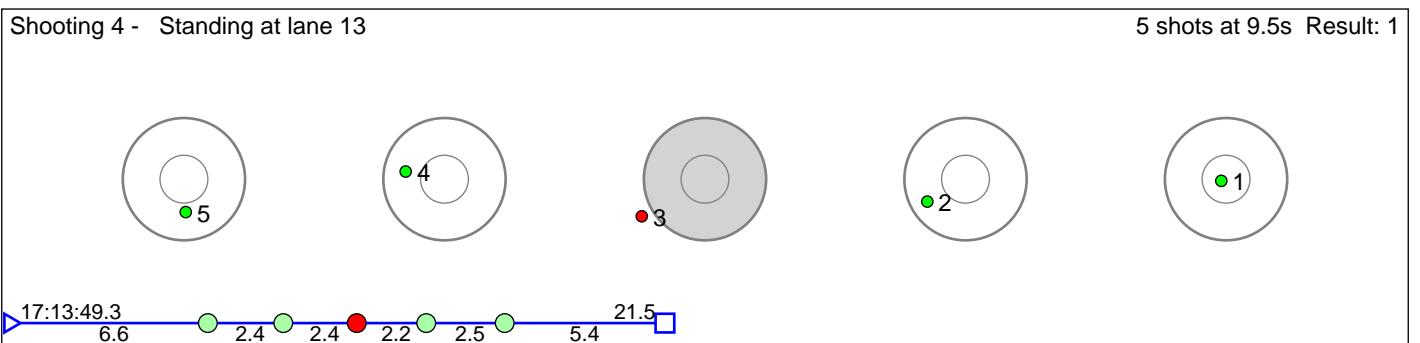
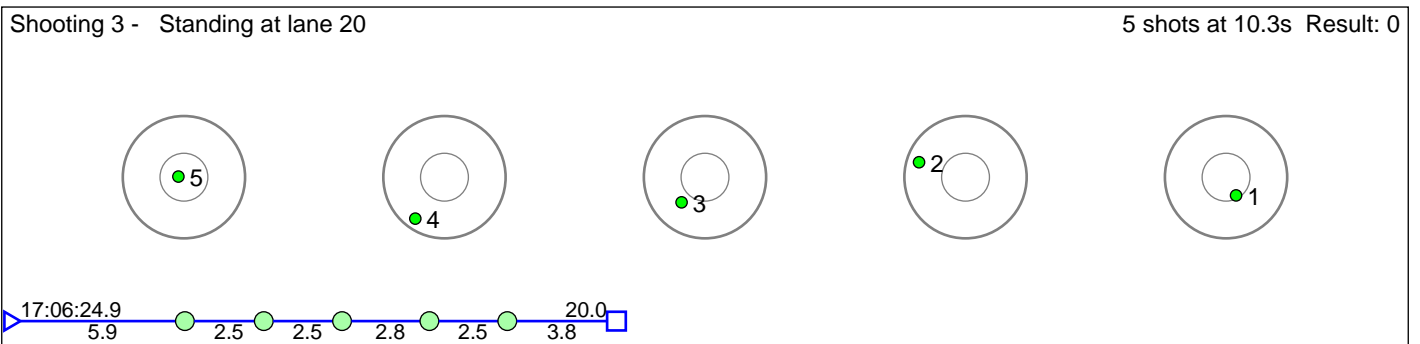
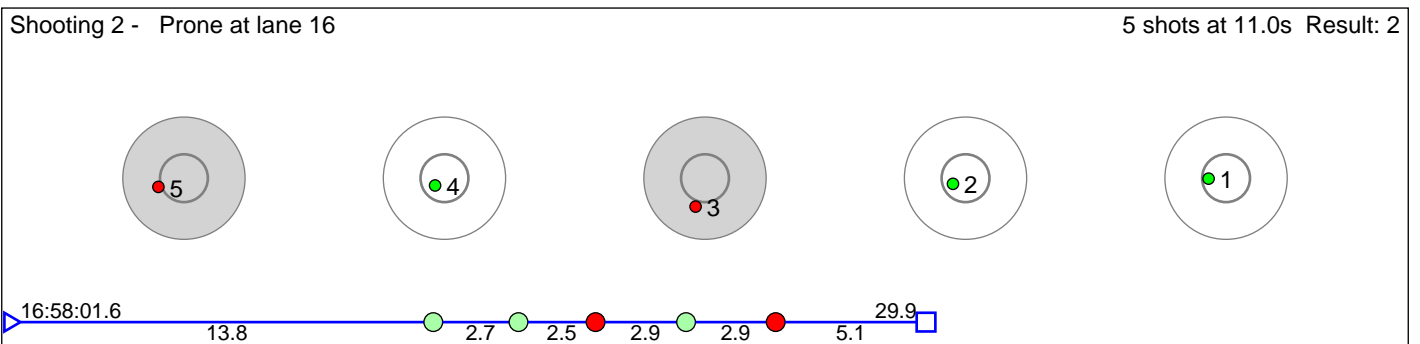
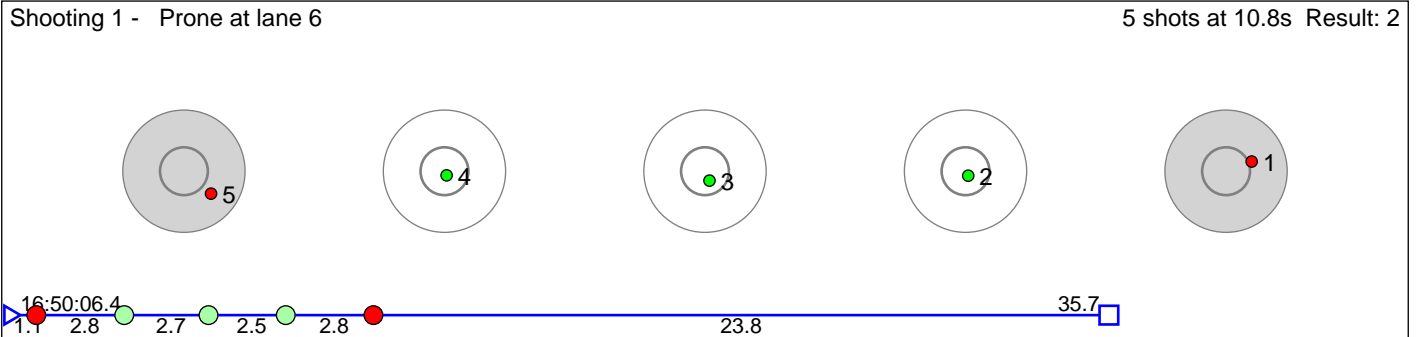

**Disclaimer:**

These results are unofficial since only the final output from the timing system can provide complete and correct competition results. The graphic plot of each series, presents the location of the shots on each of the five targets. Please observe that the accuracy of the plotting has some limitations due to image resolution and/or printer quality.

# 548 Uldal Espen

Birkenes IL

Result: 1

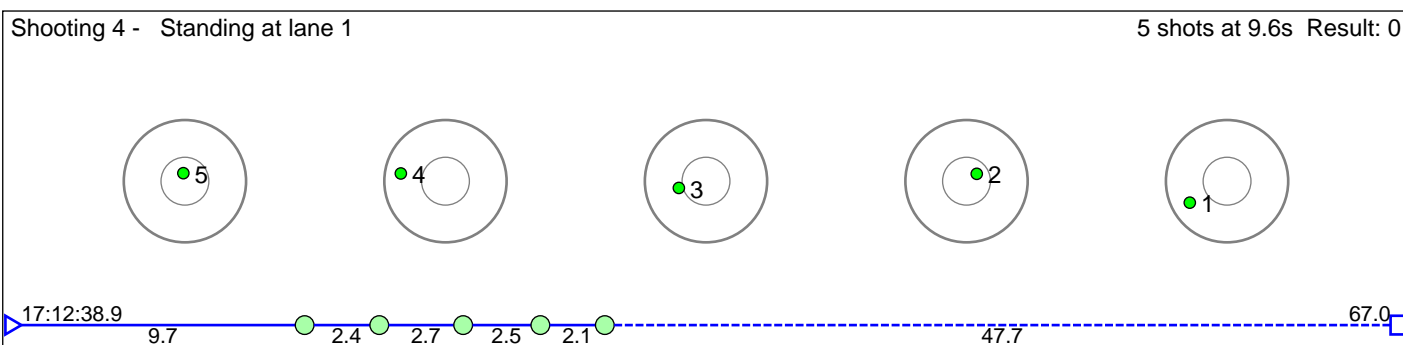
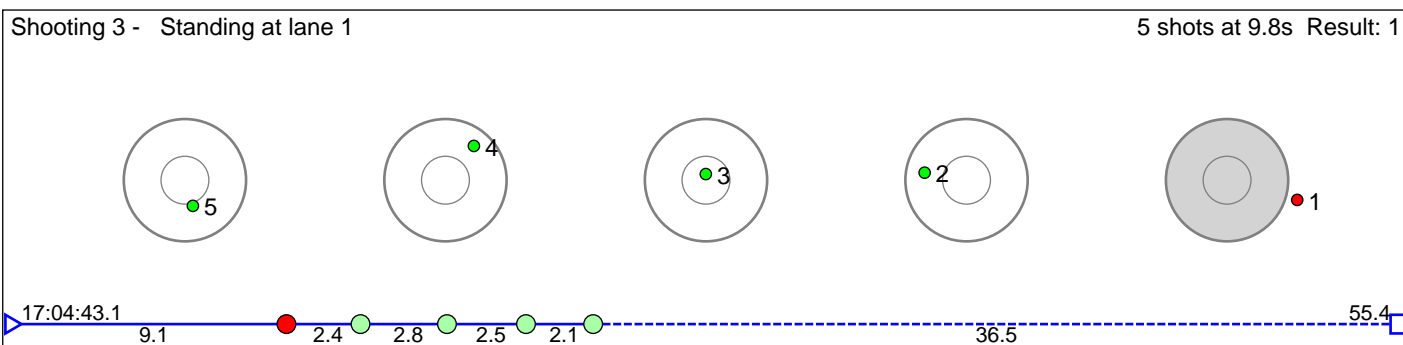
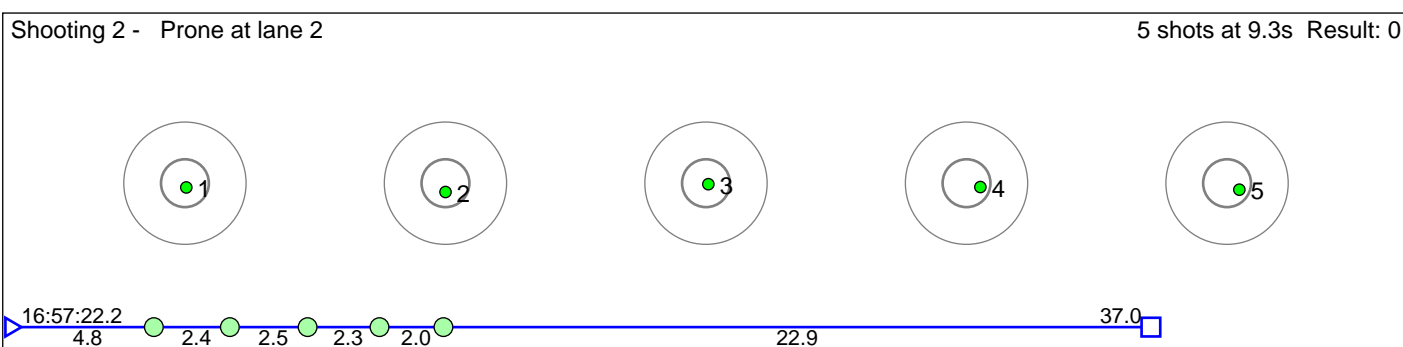
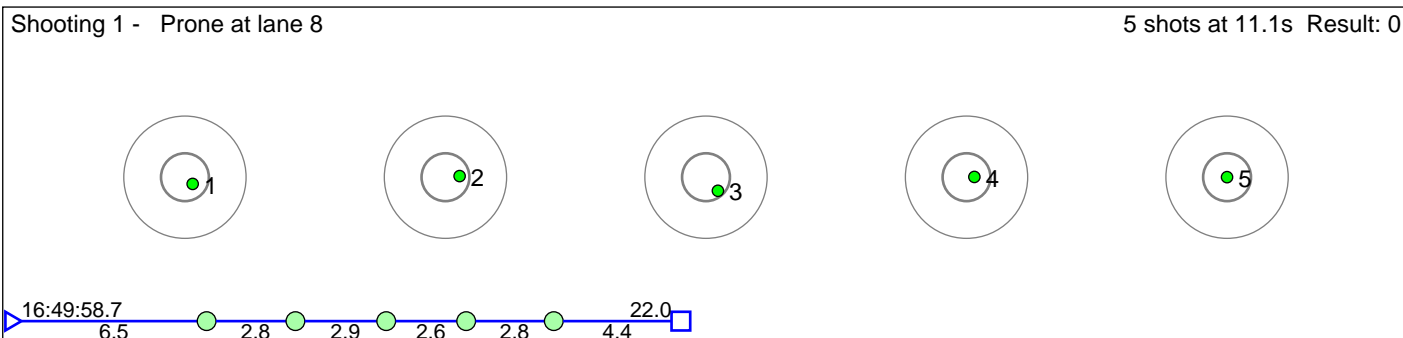

**Disclaimer:**

These results are unofficial since only the final output from the timing system can provide complete and correct competition results. The graphic plot of each series, presents the location of the shots on each of the five targets. Please observe that the accuracy of the plotting has some limitations due to image resolution and/or printer quality.

# 549 Selnæs Vegar Horneberg

Trondhjems Skiskyttere

Result: 3

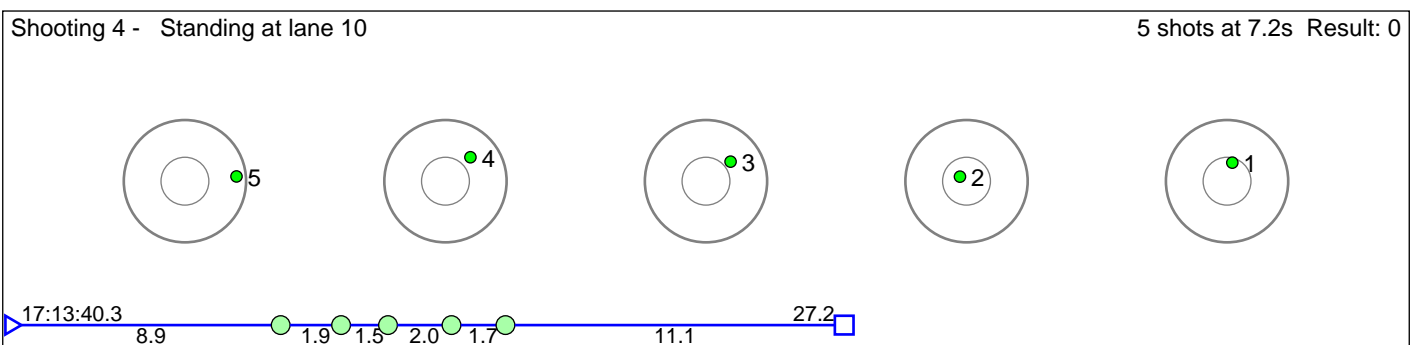
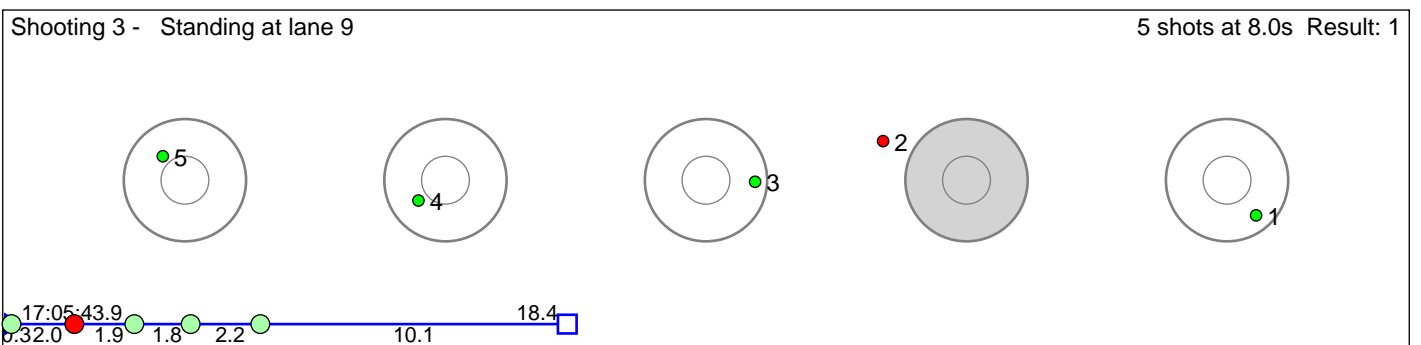
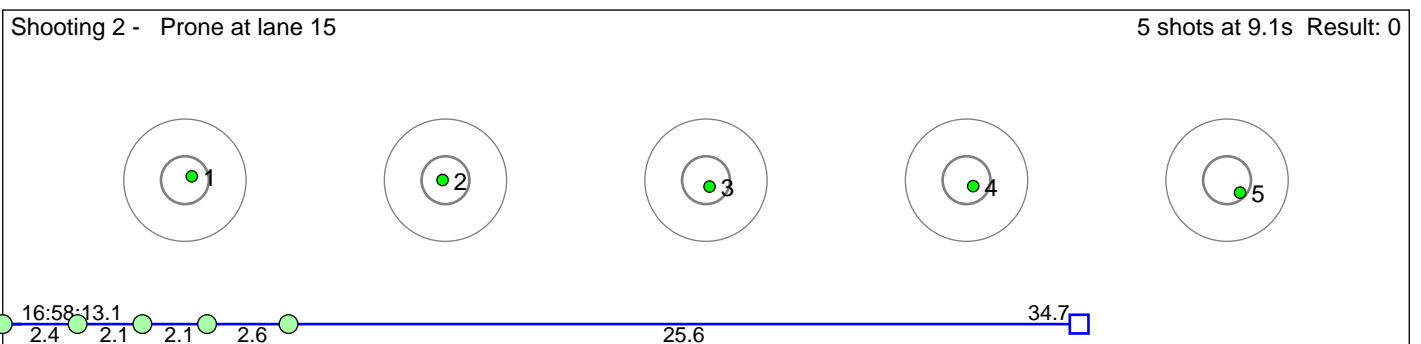
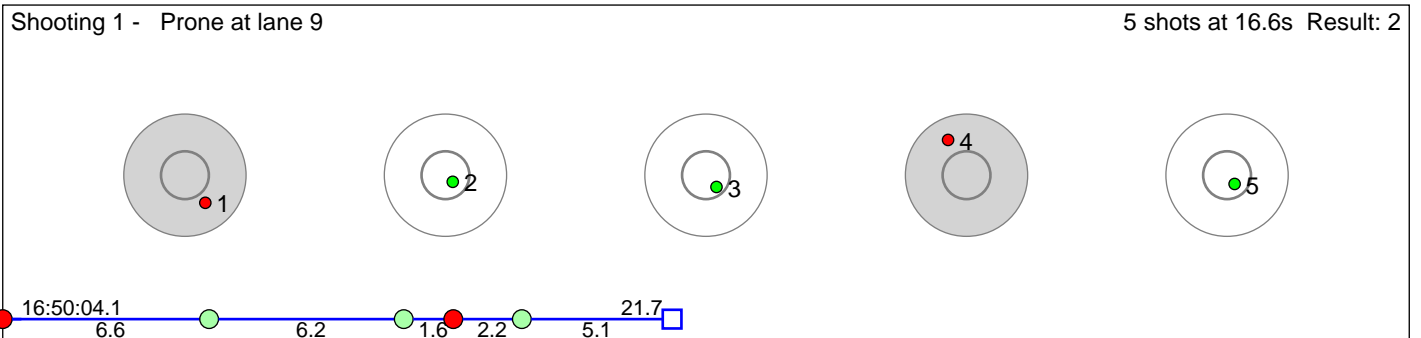

**Disclaimer:**

These results are unofficial since only the final output from the timing system can provide complete and correct competition results. The graphic plot of each series, presents the location of the shots on each of the five targets. Please observe that the accuracy of the plotting has some limitations due to image resolution and/or printer quality.



# 550 Blikra Endre

Trondhjems Skiskyttere

Result: 7

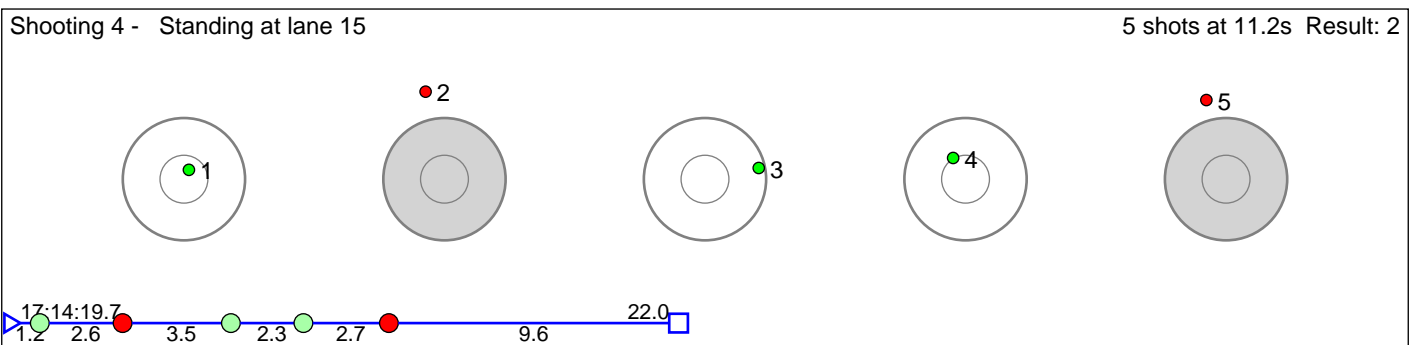
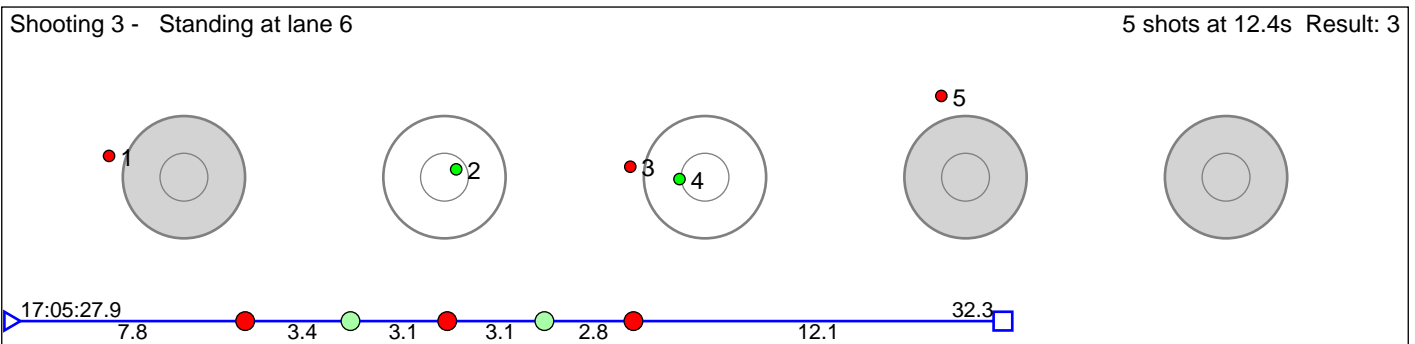
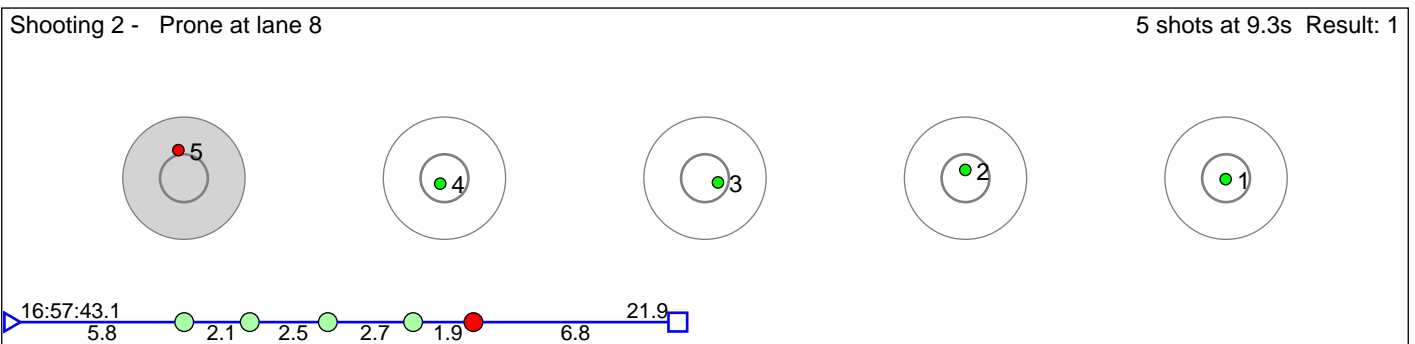
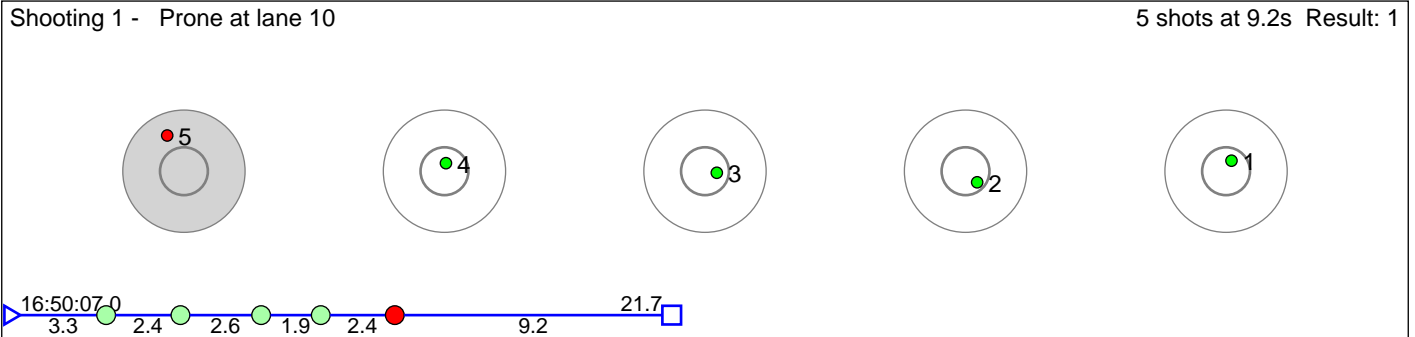

**Disclaimer:**

These results are unofficial since only the final output from the timing system can provide complete and correct competition results. The graphic plot of each series, presents the location of the shots on each of the five targets. Please observe that the accuracy of the plotting has some limitations due to image resolution and/or printer quality.

# 551 Skar Hogne Findal

Sannidal Idrettslag

Result: 2

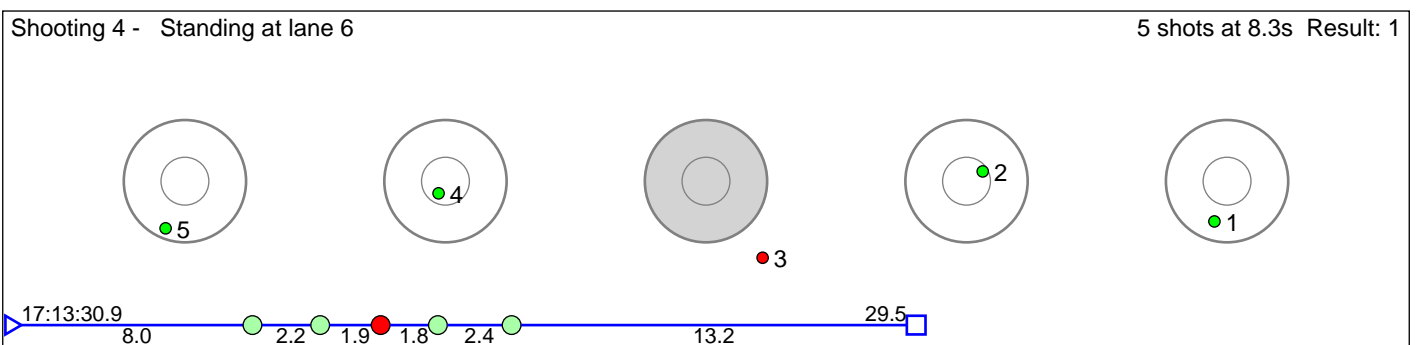
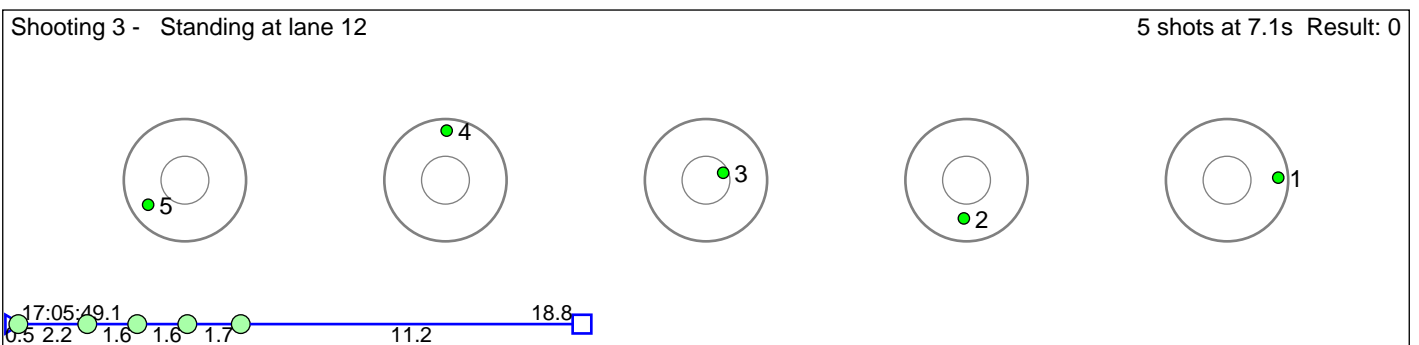
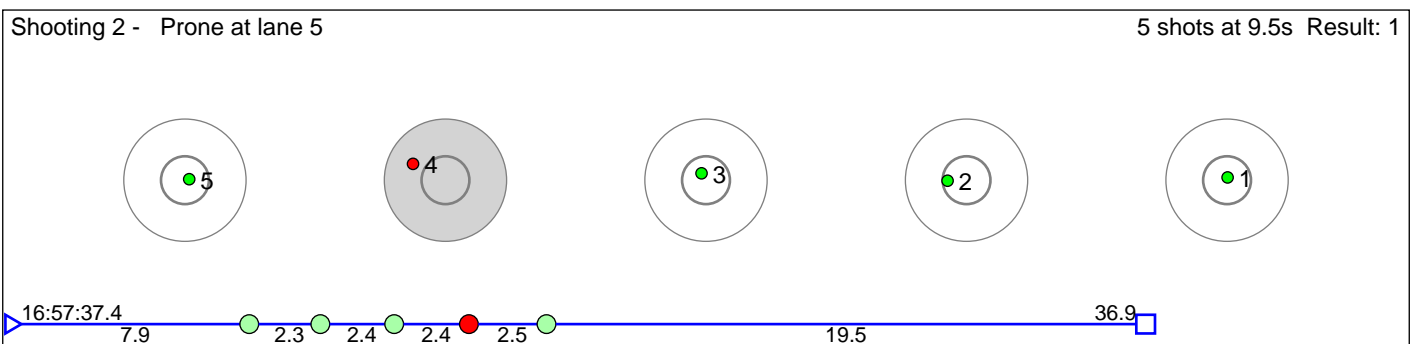
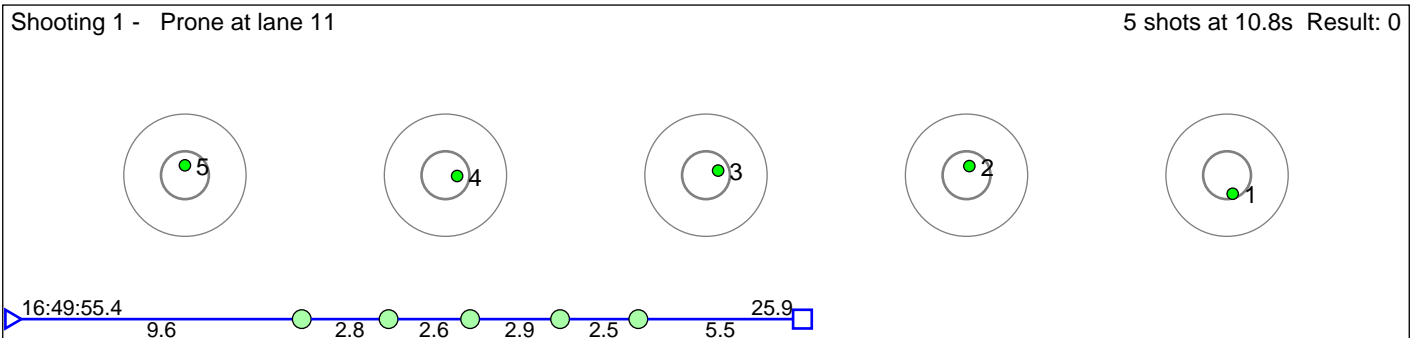

**Disclaimer:**

These results are unofficial since only the final output from the timing system can provide complete and correct competition results. The graphic plot of each series, presents the location of the shots on each of the five targets. Please observe that the accuracy of the plotting has some limitations due to image resolution and/or printer quality.

# 552 Borge Herman Dramdal

Svene IL

Result: 2

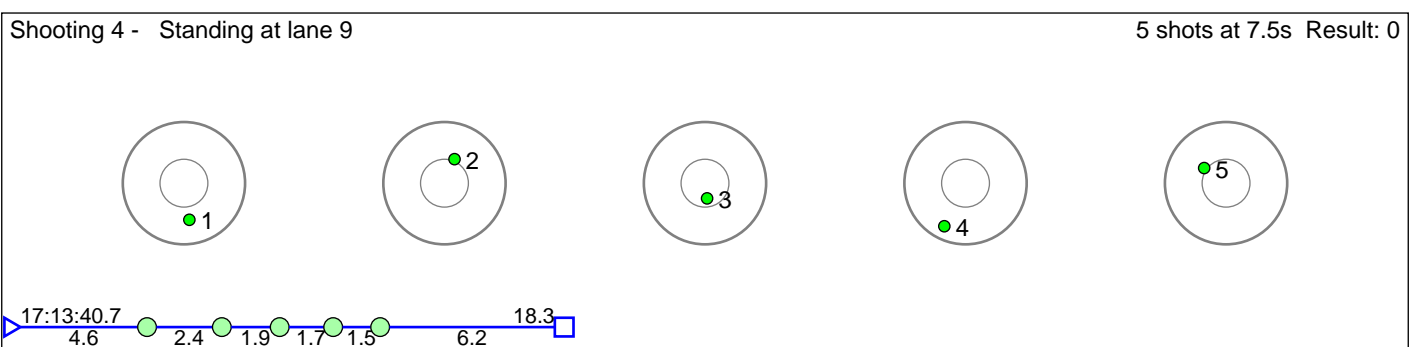
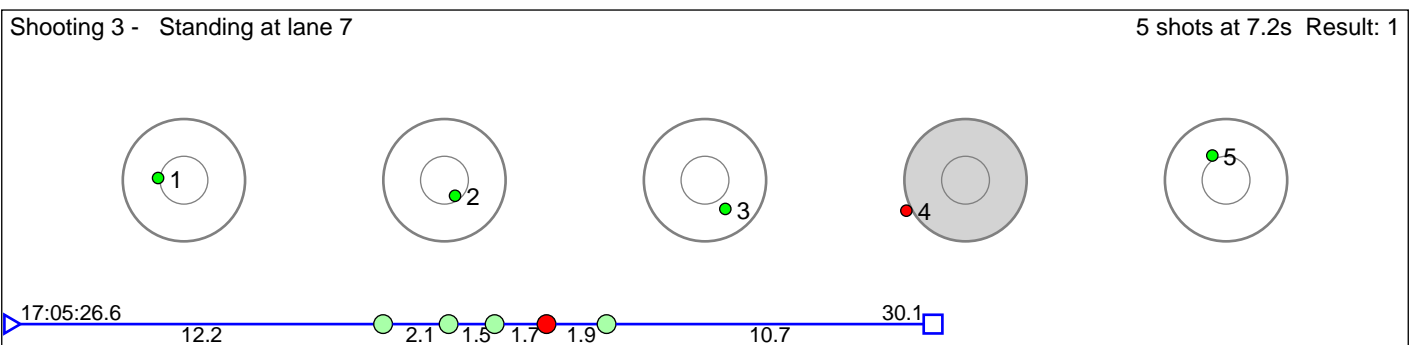
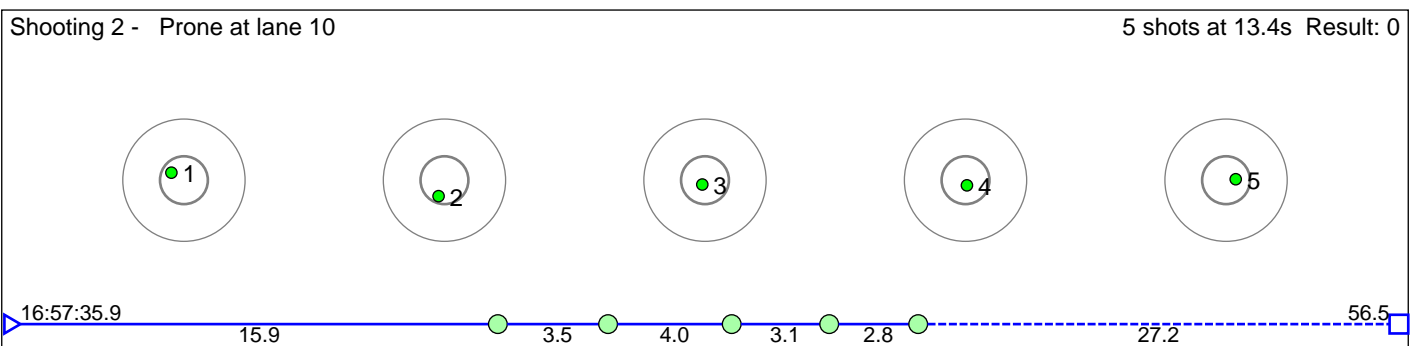
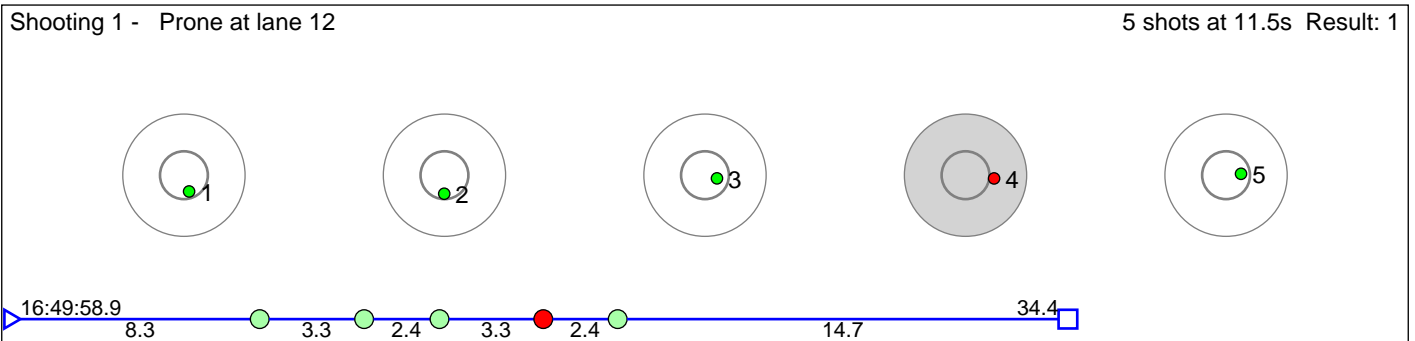

**Disclaimer:**

These results are unofficial since only the final output from the timing system can provide complete and correct competition results. The graphic plot of each series, presents the location of the shots on each of the five targets. Please observe that the accuracy of the plotting has some limitations due to image resolution and/or printer quality.

# 553 Gerhardsen Eirik Silsand

Tromsø Skiskytterlag

Result: 2

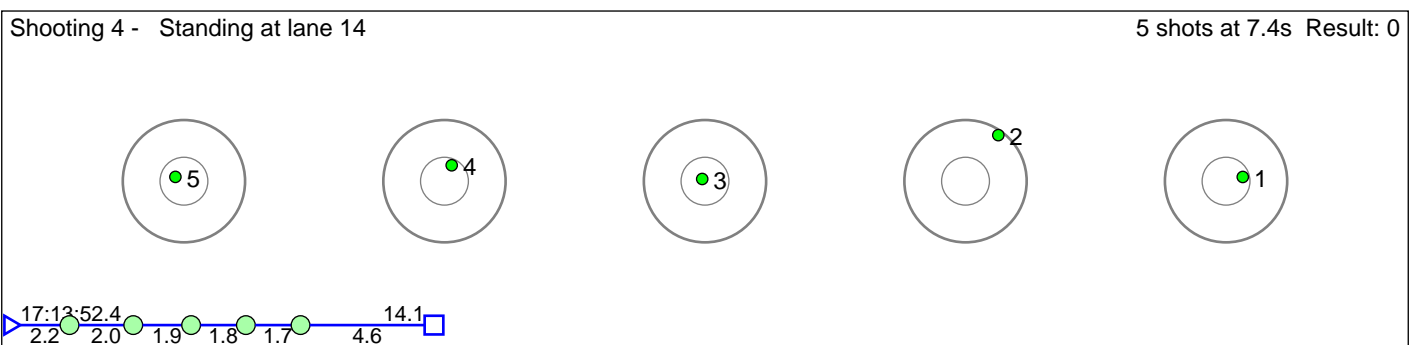
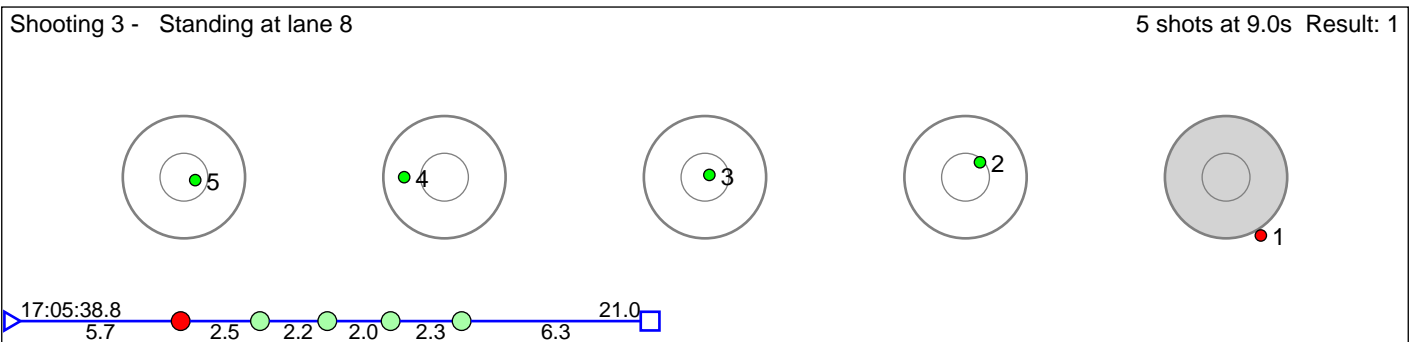
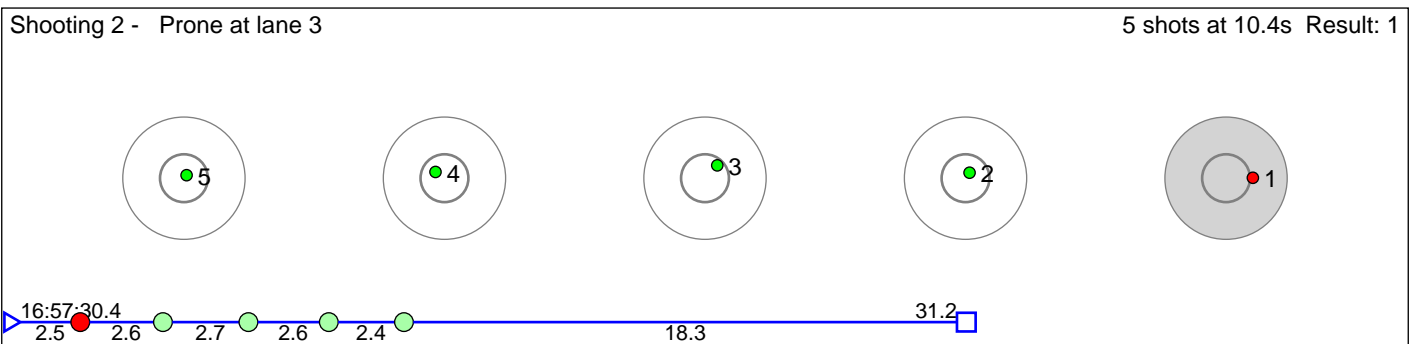
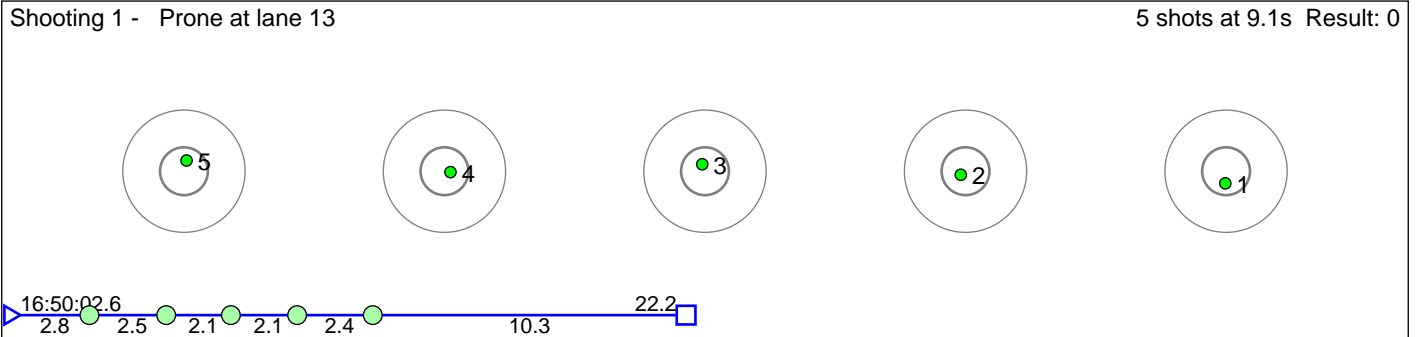

**Disclaimer:**

These results are unofficial since only the final output from the timing system can provide complete and correct competition results. The graphic plot of each series, presents the location of the shots on each of the five targets. Please observe that the accuracy of the plotting has some limitations due to image resolution and/or printer quality.

# 554 Bekken Sivert

Kvikne IL

Result: 3

Shooting 1 - Prone at lane 14 5 shots at 11.3s Result: 1

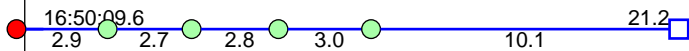
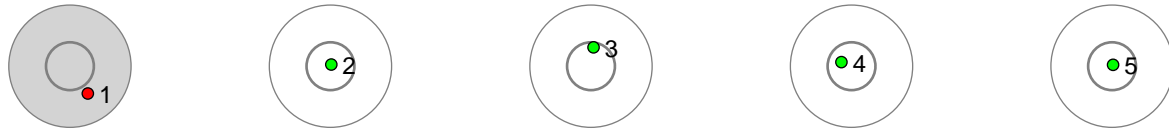

Shooting 2 - Prone at lane 12 5 shots at 11.7s Result: 0

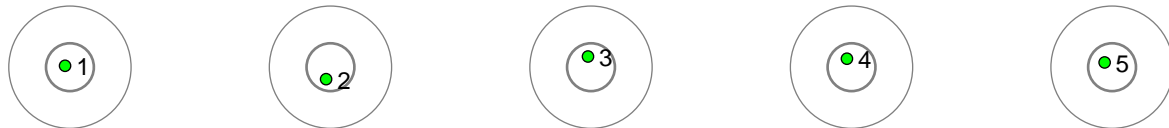

Shooting 3 - Standing at lane 10 5 shots at 10.6s Result: 1

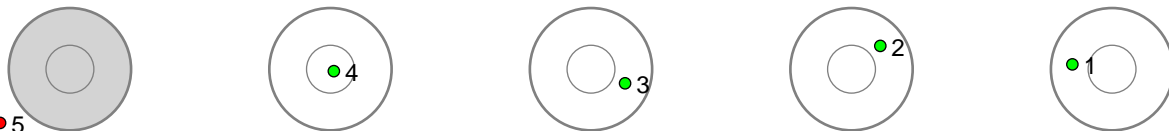

Shooting 4 - Standing at lane 8 5 shots at 11.0s Result: 1

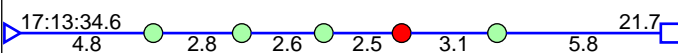
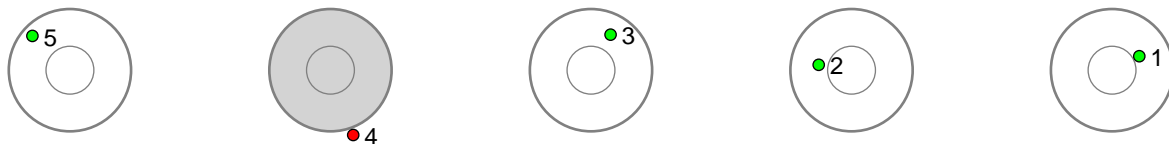

**Disclaimer:**

These results are unofficial since only the final output from the timing system can provide complete and correct competition results. The graphic plot of each series, presents the location of the shots on each of the five targets. Please observe that the accuracy of the plotting has some limitations due to image resolution and/or printer quality.

# 555 Galåen Håvard Kne

Røros IL

Result: 1

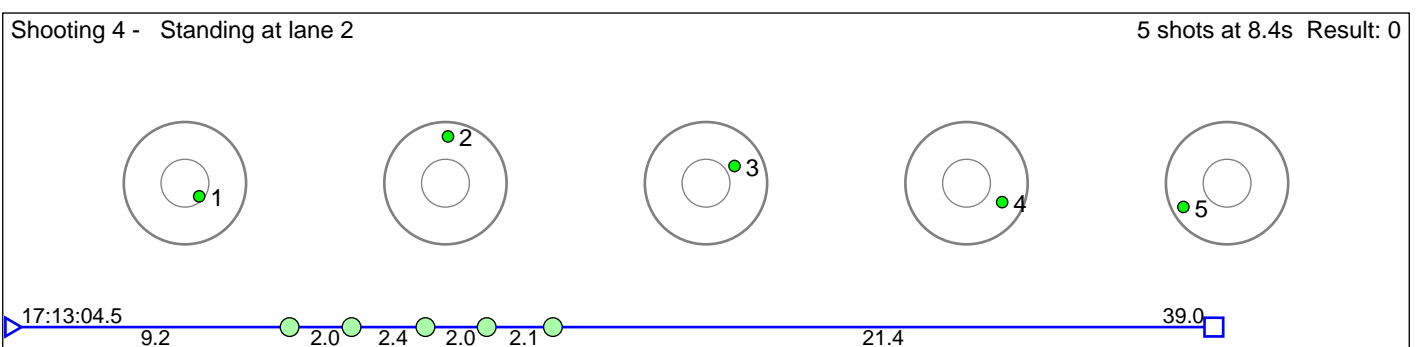
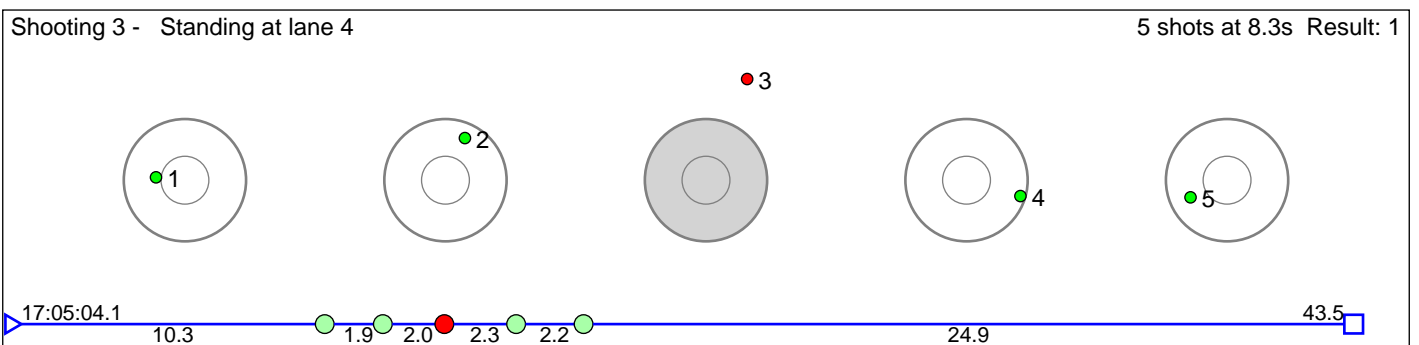
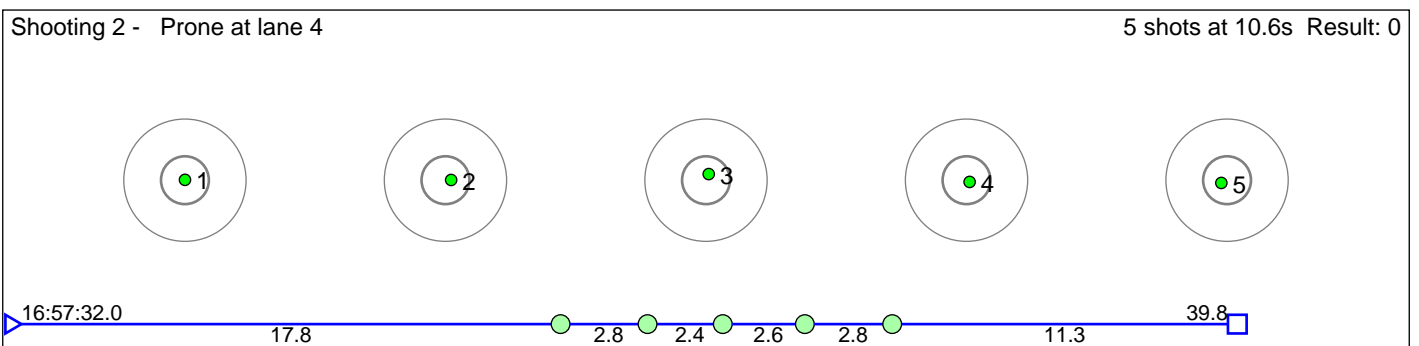
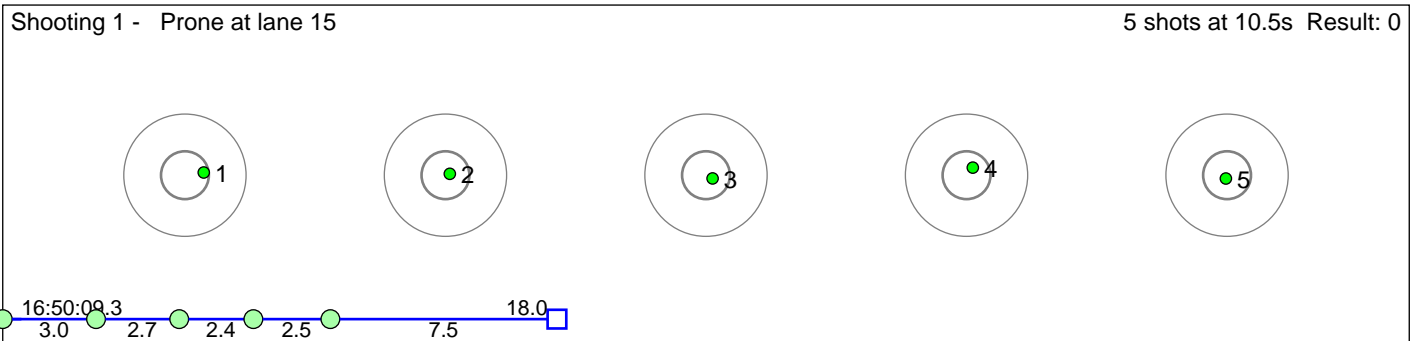

**Disclaimer:**

These results are unofficial since only the final output from the timing system can provide complete and correct competition results. The graphic plot of each series, presents the location of the shots on each of the five targets. Please observe that the accuracy of the plotting has some limitations due to image resolution and/or printer quality.

# 556 Fløttum Adrian

Sokna IL

Result: 3

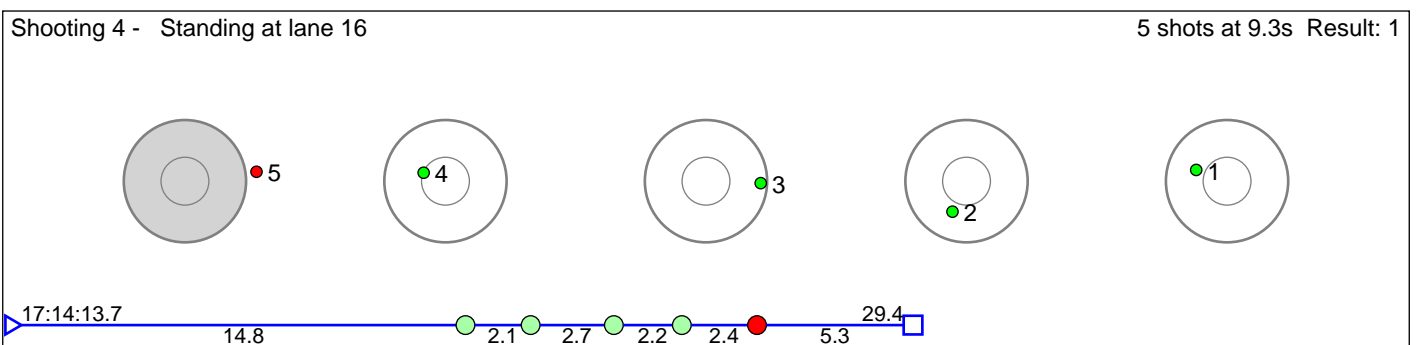
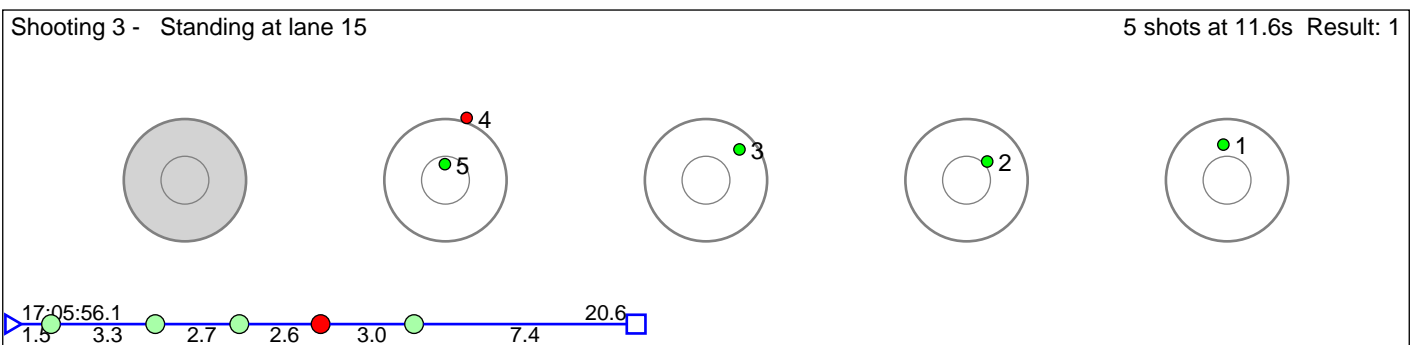
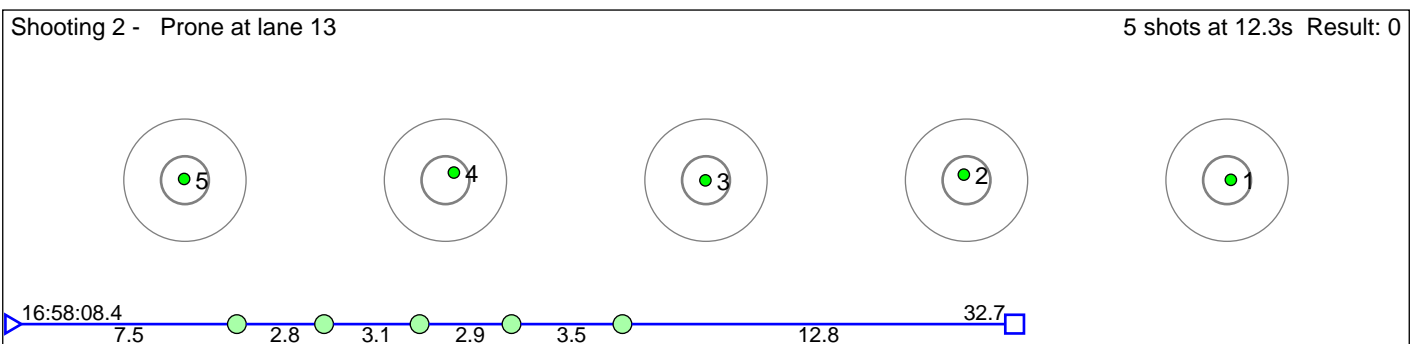
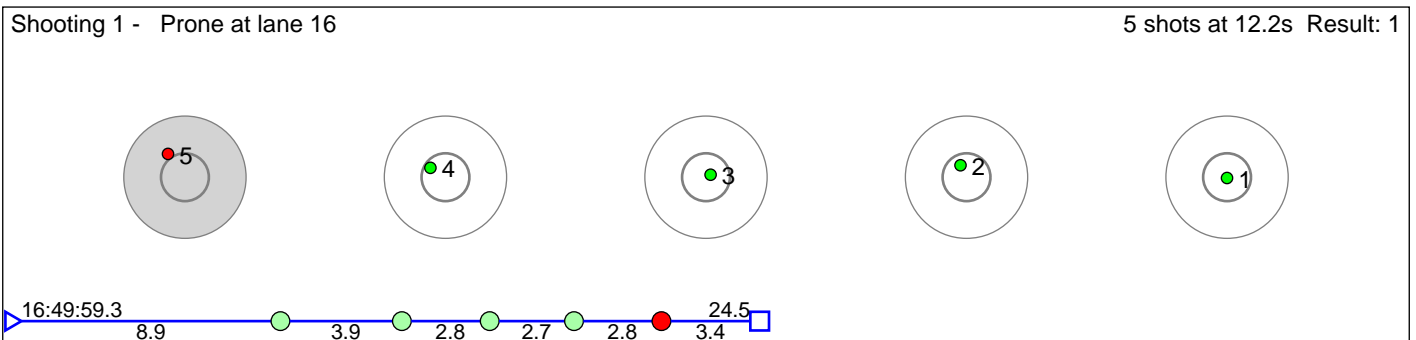

**Disclaimer:**

These results are unofficial since only the final output from the timing system can provide complete and correct competition results. The graphic plot of each series, presents the location of the shots on each of the five targets. Please observe that the accuracy of the plotting has some limitations due to image resolution and/or printer quality.

# 557 Mangset Even

MjøsSki

Result: 6

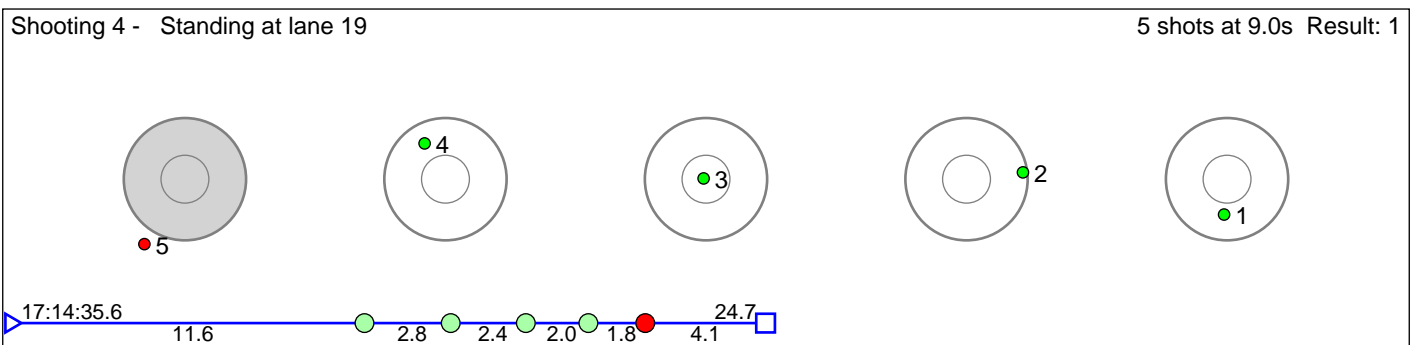
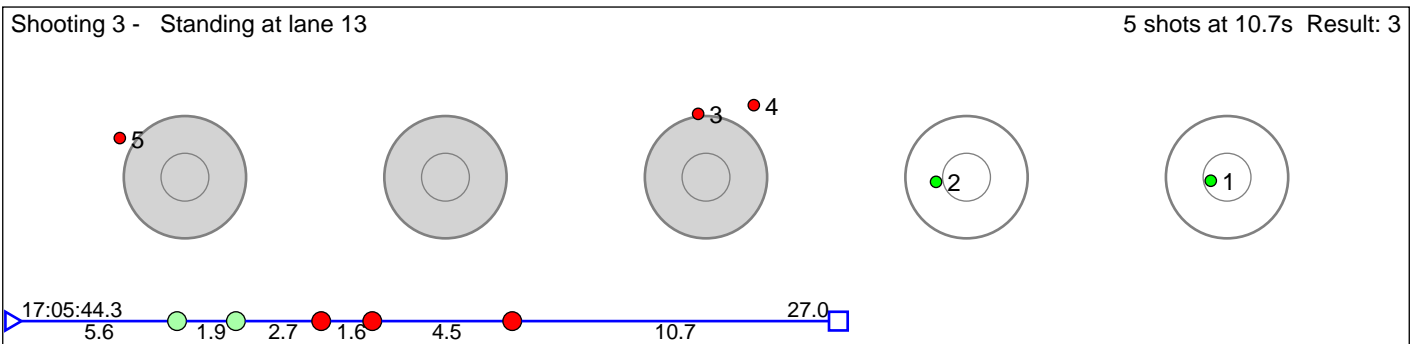
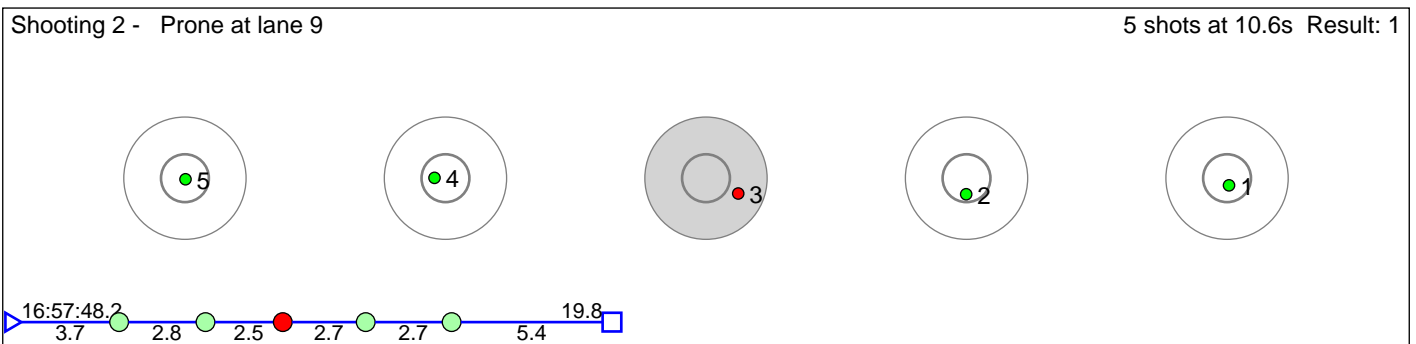
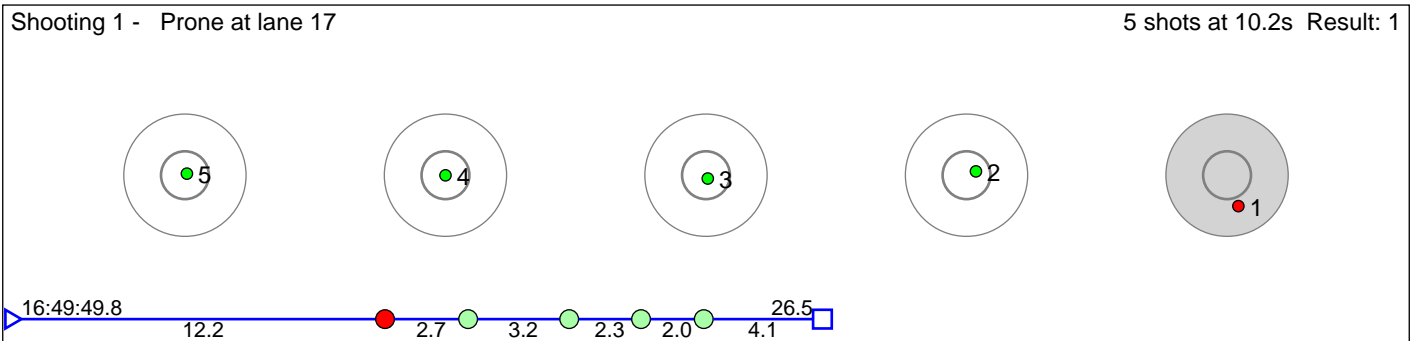

**Disclaimer:**

These results are unofficial since only the final output from the timing system can provide complete and correct competition results. The graphic plot of each series, presents the location of the shots on each of the five targets. Please observe that the accuracy of the plotting has some limitations due to image resolution and/or printer quality.



# 558 Winsvold Bendik

Lier IL

Result: 6

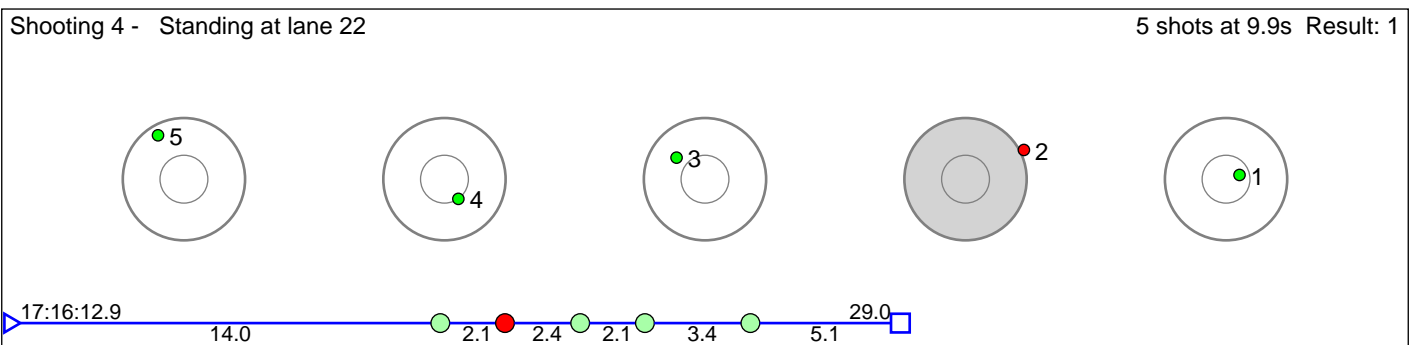
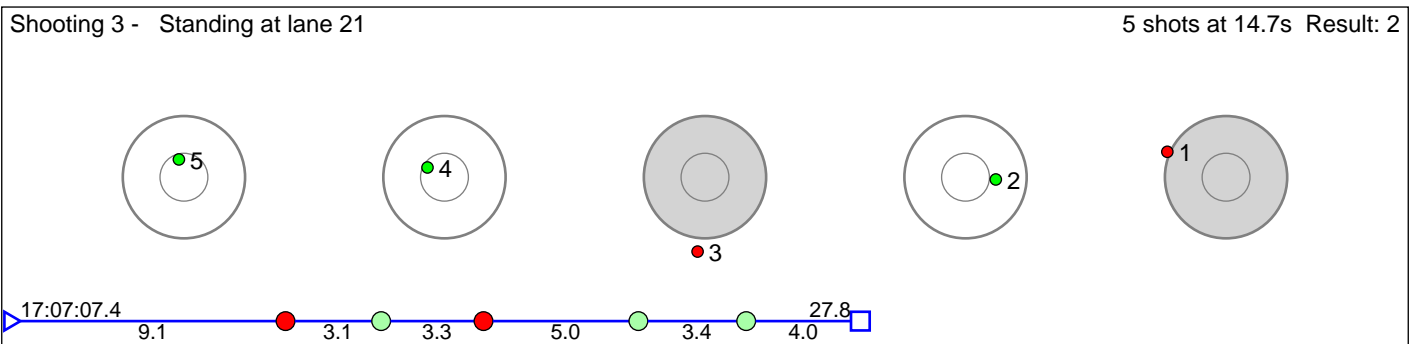
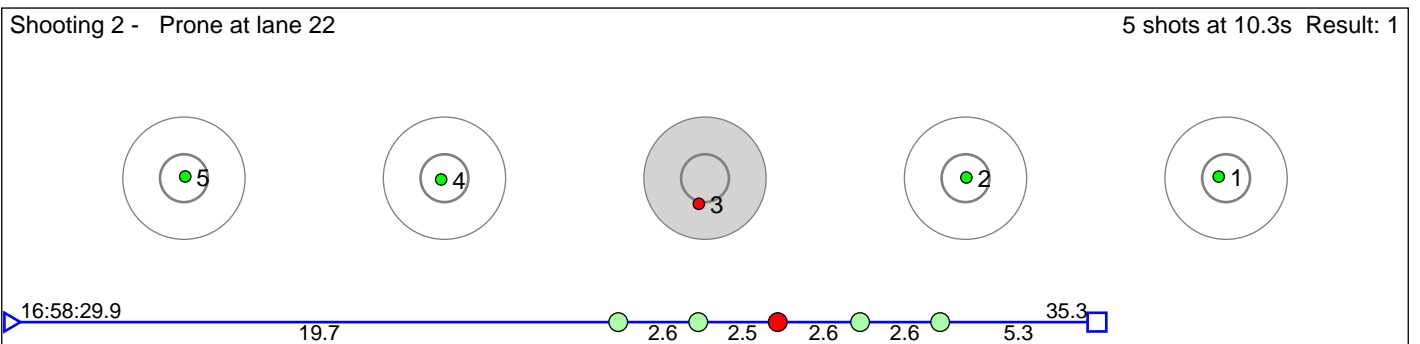
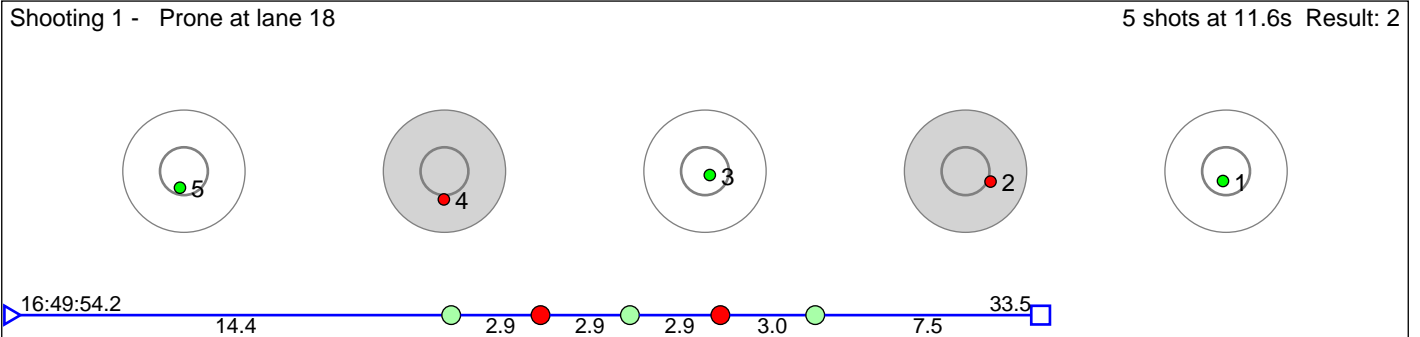

**Disclaimer:**

These results are unofficial since only the final output from the timing system can provide complete and correct competition results. The graphic plot of each series, presents the location of the shots on each of the five targets. Please observe that the accuracy of the plotting has some limitations due to image resolution and/or printer quality.

# 559 Karlsen Aleksander Morsund

Lier IL

Result: 6

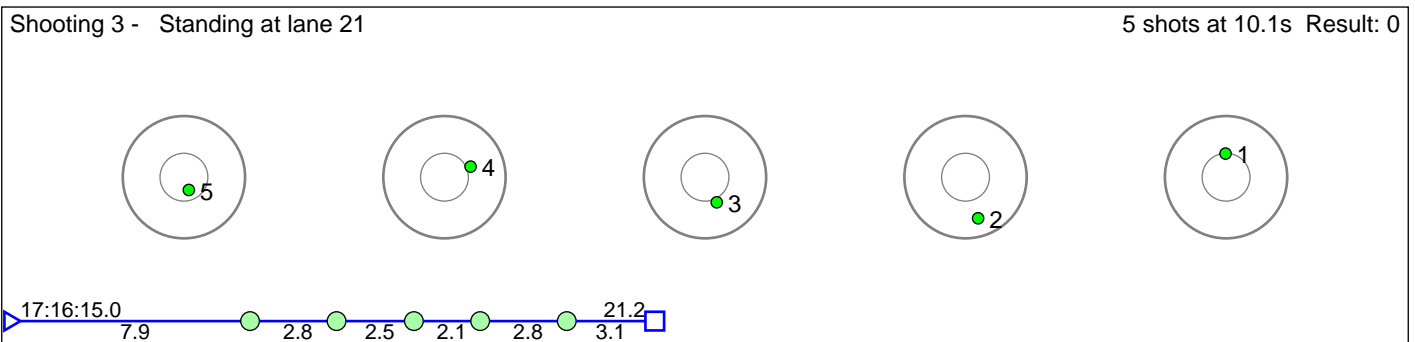
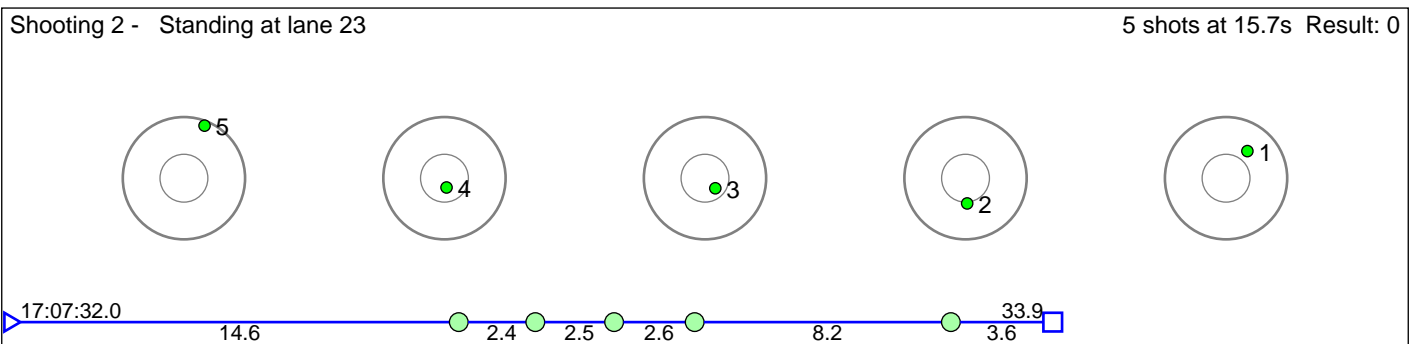
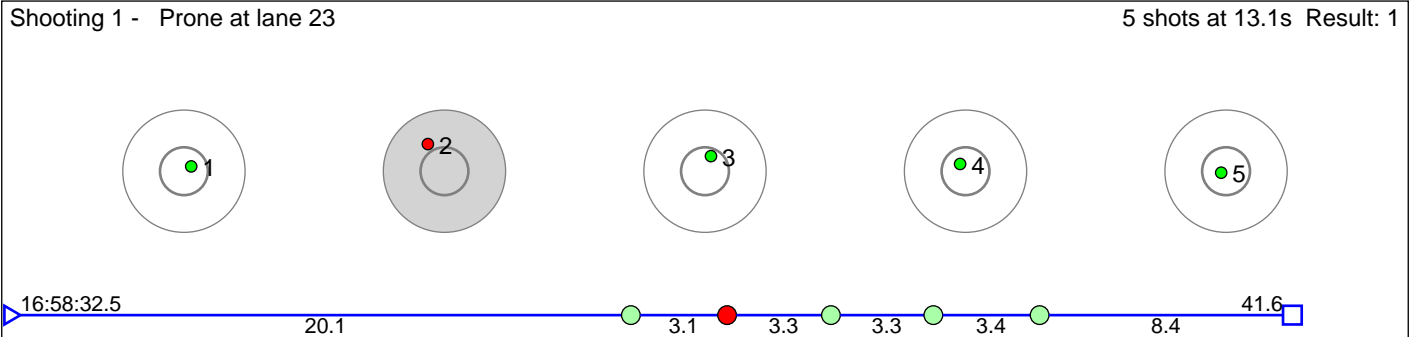

**Disclaimer:**

These results are unofficial since only the final output from the timing system can provide complete and correct competition results. The graphic plot of each series, presents the location of the shots on each of the five targets. Please observe that the accuracy of the plotting has some limitations due to image resolution and/or printer quality.

# 560 Mathisen Martin Bjørndalen

Simostranda IL

Result: 6

Shooting 1 - Prone at lane 20 5 shots at 12.2s Result: 1

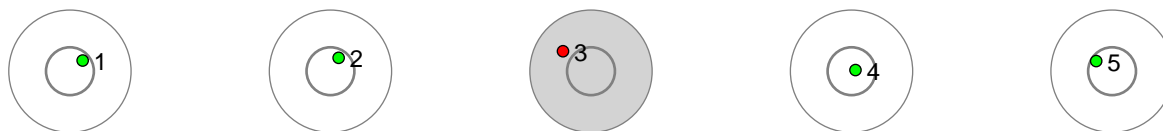

Shooting 2 - Prone at lane 14 5 shots at 13.1s Result: 2

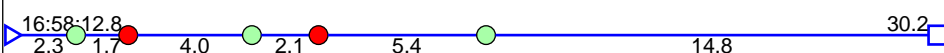
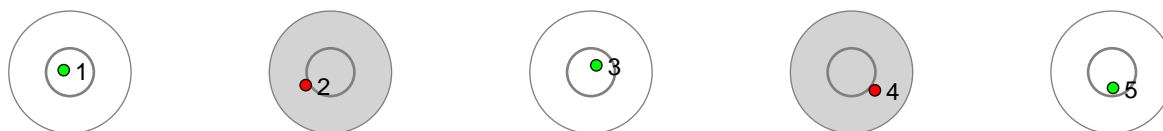

Shooting 3 - Standing at lane 22 5 shots at 8.9s Result: 3

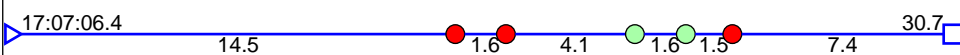
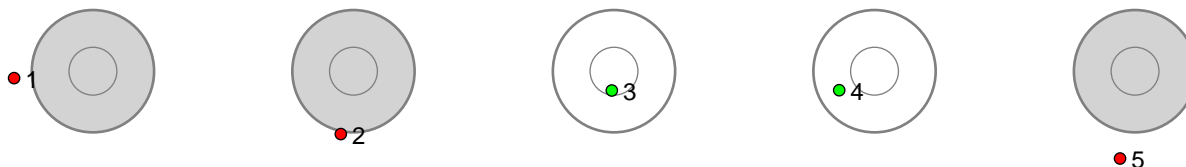

Shooting 4 - Standing at lane 23 5 shots at 6.2s Result: 0

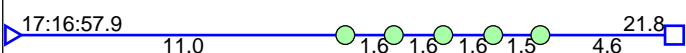
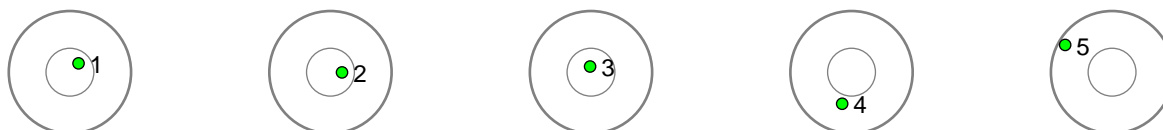

**Disclaimer:**

These results are unofficial since only the final output from the timing system can provide complete and correct competition results. The graphic plot of each series, presents the location of the shots on each of the five targets. Please observe that the accuracy of the plotting has some limitations due to image resolution and/or printer quality.

# 561 Hopland Isak Nikolai

Hardbagg IL

Result: 6

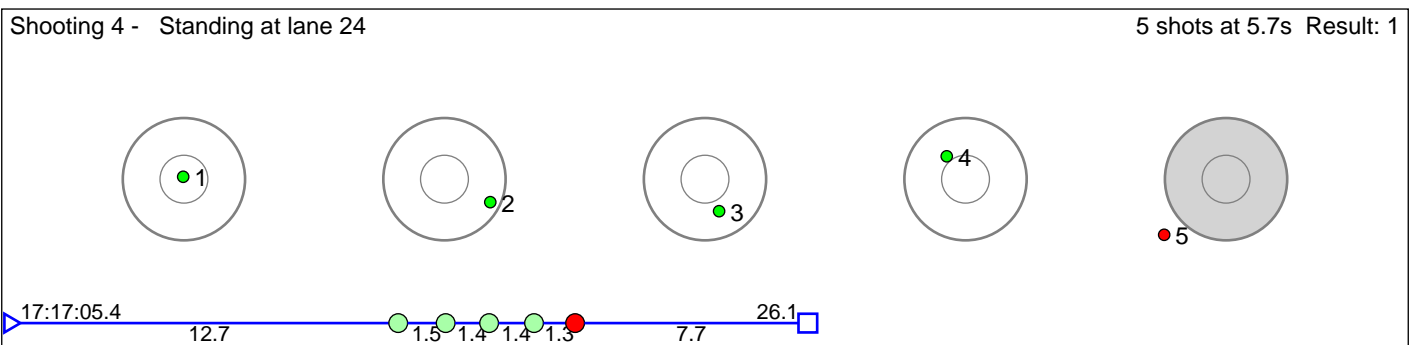
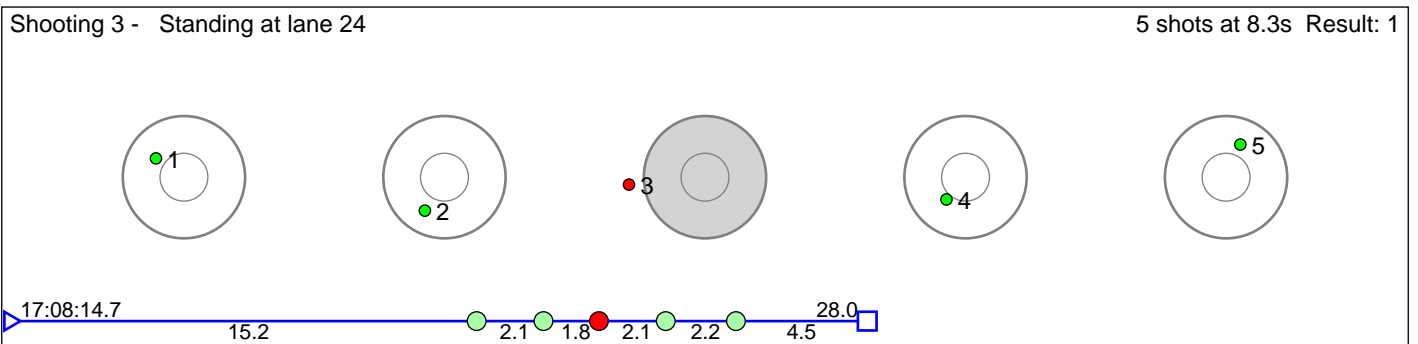
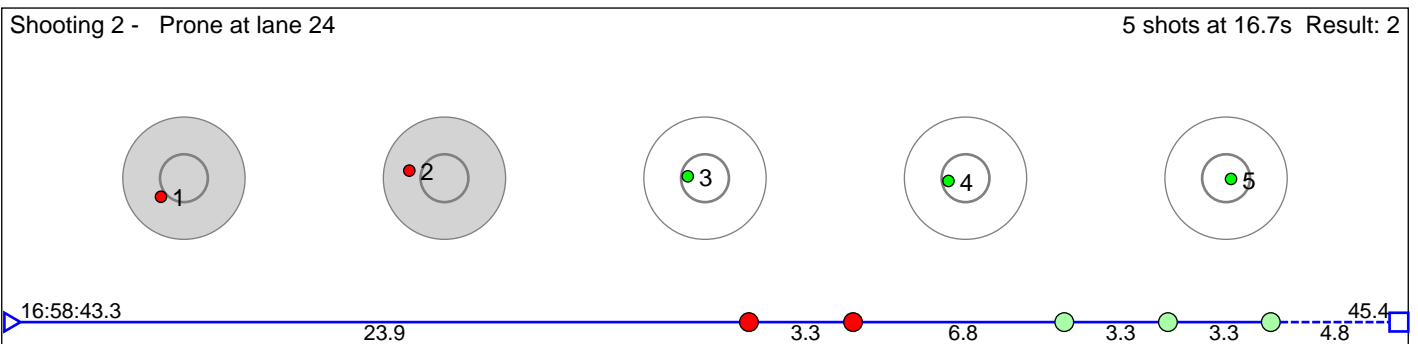
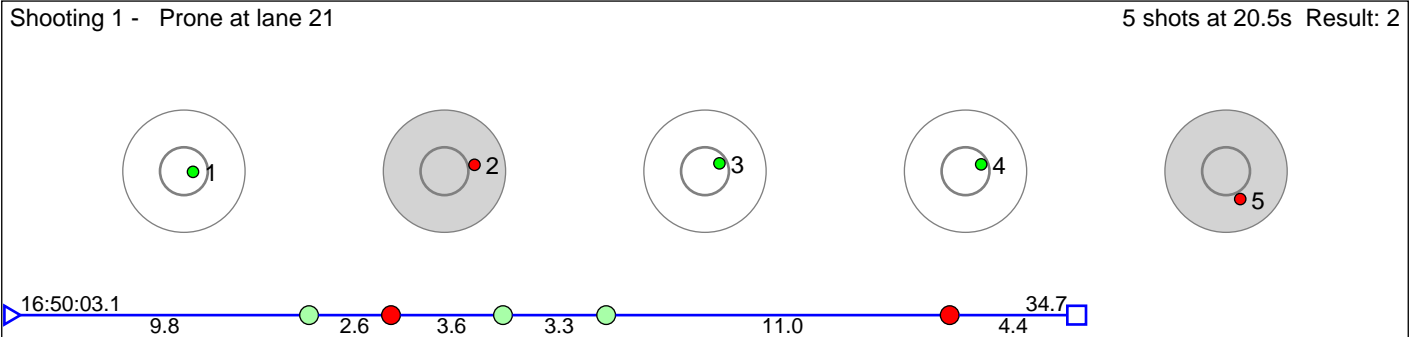

**Disclaimer:**

These results are unofficial since only the final output from the timing system can provide complete and correct competition results. The graphic plot of each series, presents the location of the shots on each of the five targets. Please observe that the accuracy of the plotting has some limitations due to image resolution and/or printer quality.

# 562 Bjørndalen Dag Sander

Simostranda IL

Result: 2

Shooting 1 - Prone at lane 22 5 shots at 14.4s Result: 1

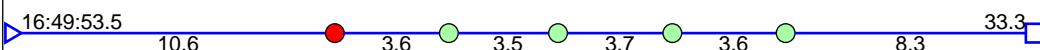
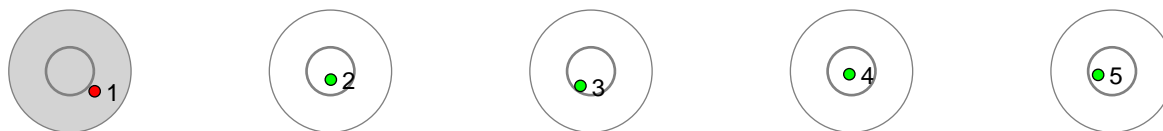

Shooting 2 - Prone at lane 11 5 shots at 16.1s Result: 0

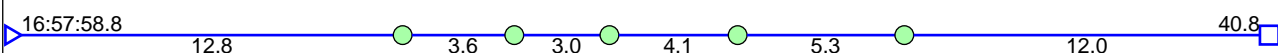
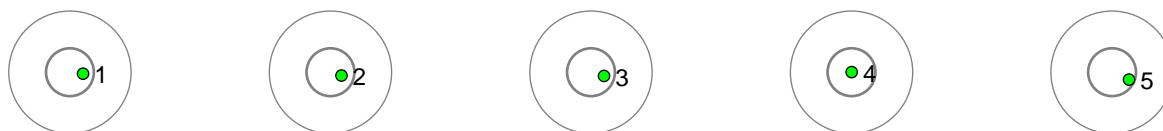

Shooting 3 - Standing at lane 14 5 shots at 8.1s Result: 1

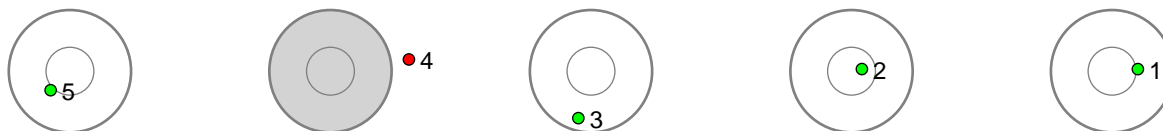

Shooting 4 - Standing at lane 12 5 shots at 8.7s Result: 0

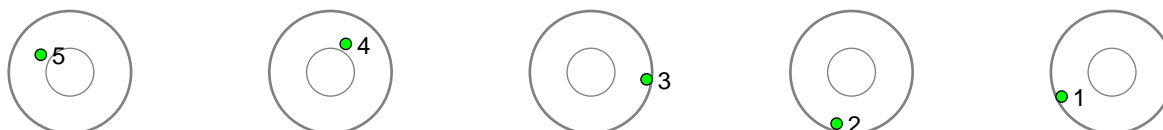

**Disclaimer:**

These results are unofficial since only the final output from the timing system can provide complete and correct competition results. The graphic plot of each series, presents the location of the shots on each of the five targets. Please observe that the accuracy of the plotting has some limitations due to image resolution and/or printer quality.

# 563 Garli Odin

Sokna IL

Result: 4

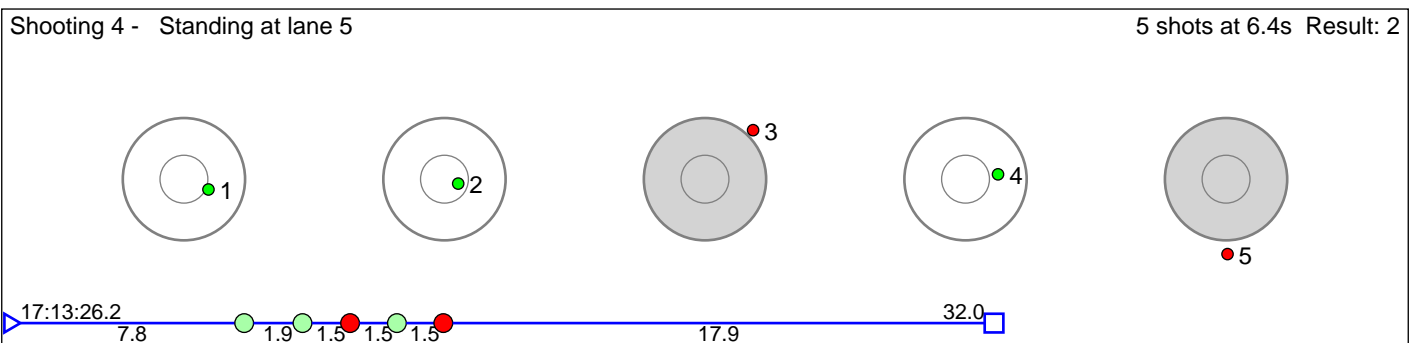
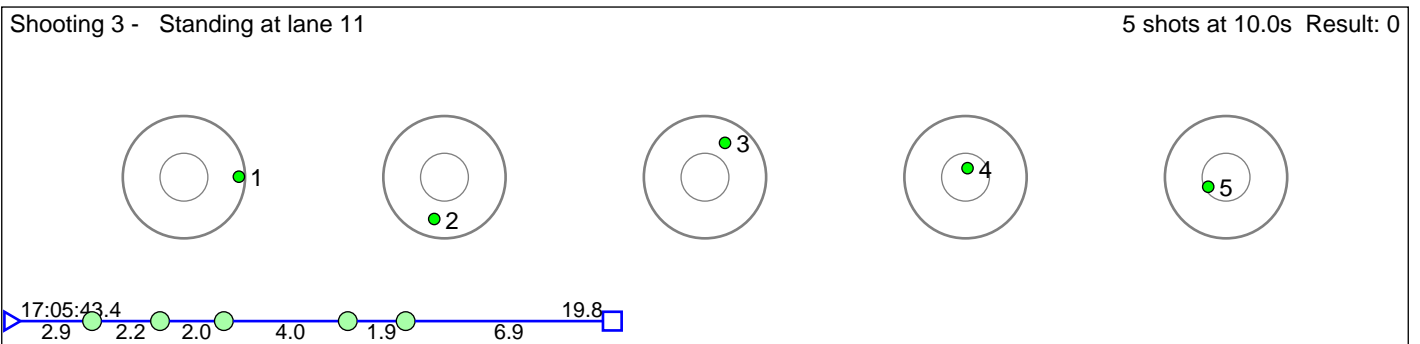
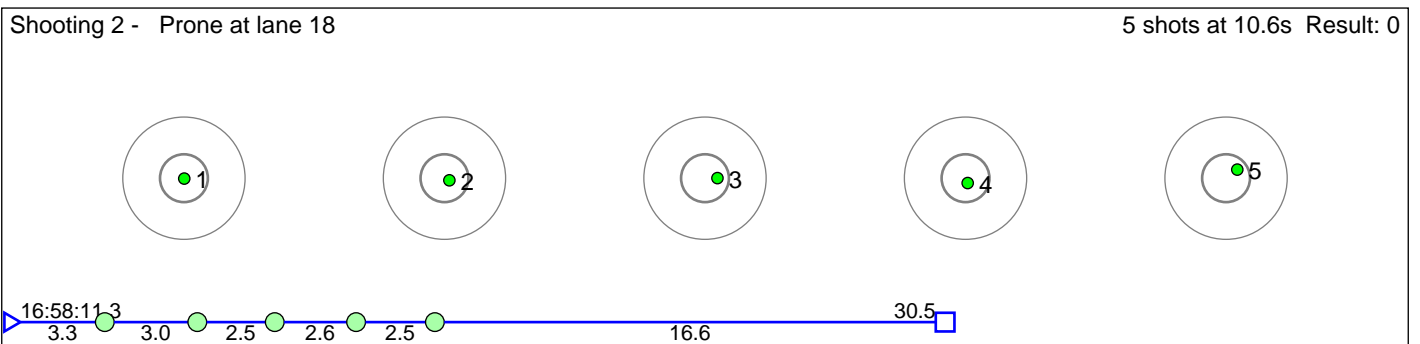
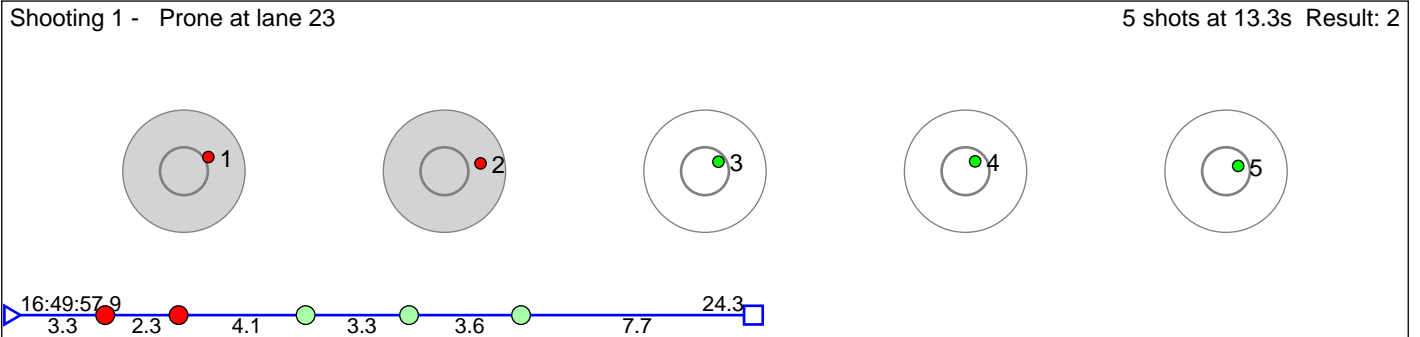

**Disclaimer:**

These results are unofficial since only the final output from the timing system can provide complete and correct competition results. The graphic plot of each series, presents the location of the shots on each of the five targets. Please observe that the accuracy of the plotting has some limitations due to image resolution and/or printer quality.

# 564 Fosse Arild

Voss Skiskytterlag

Result: 3

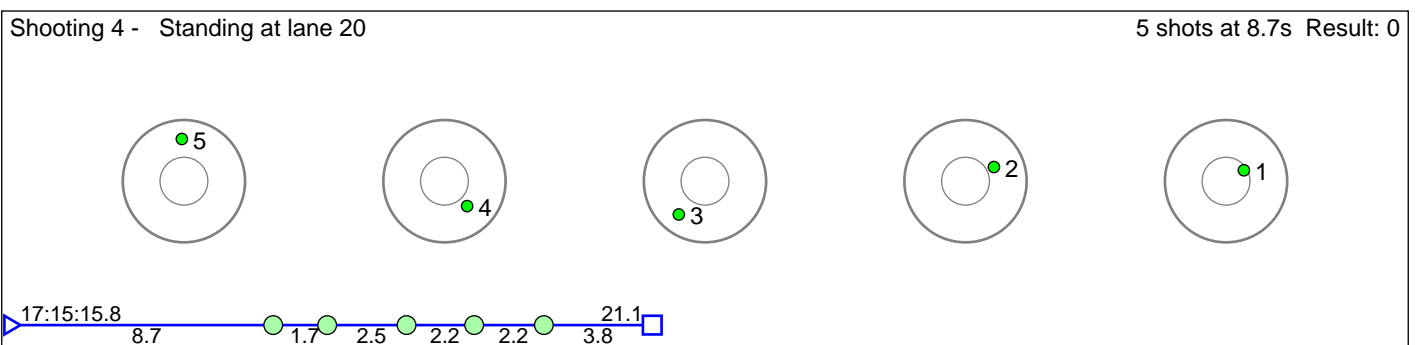
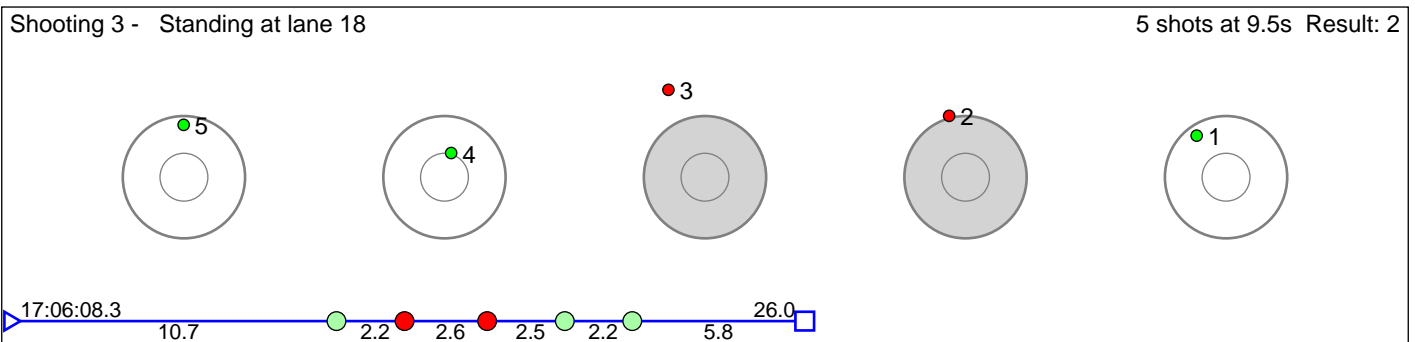
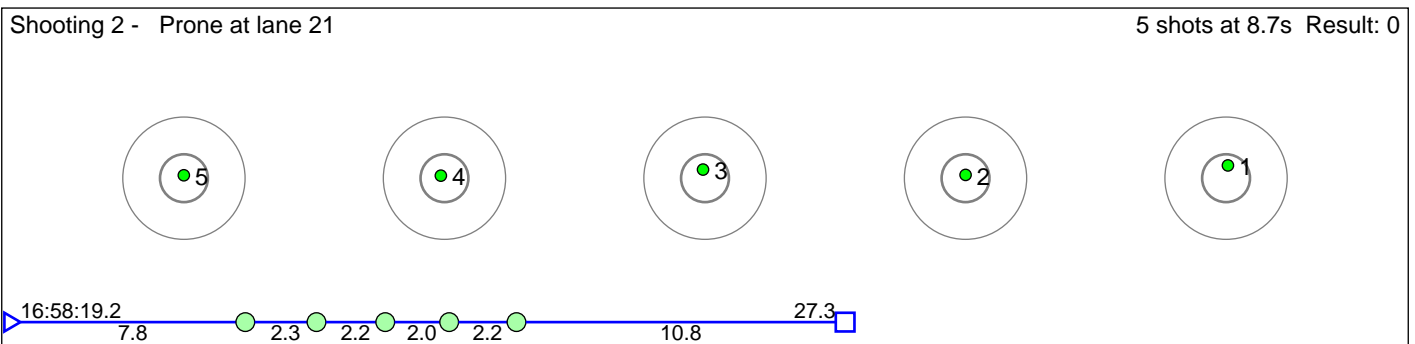
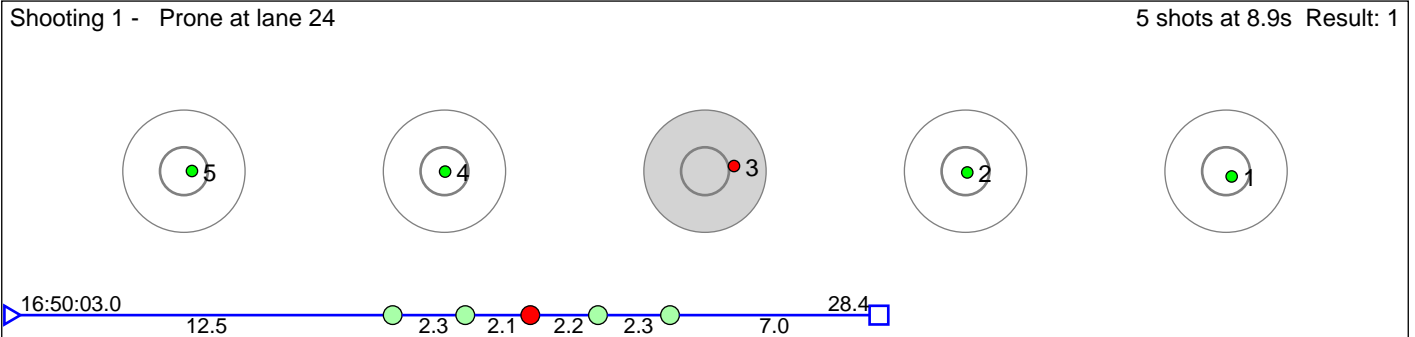

**Disclaimer:**

These results are unofficial since only the final output from the timing system can provide complete and correct competition results. The graphic plot of each series, presents the location of the shots on each of the five targets. Please observe that the accuracy of the plotting has some limitations due to image resolution and/or printer quality.

# 565 Skrede Vegard

Hardbagg IL

Result: 8

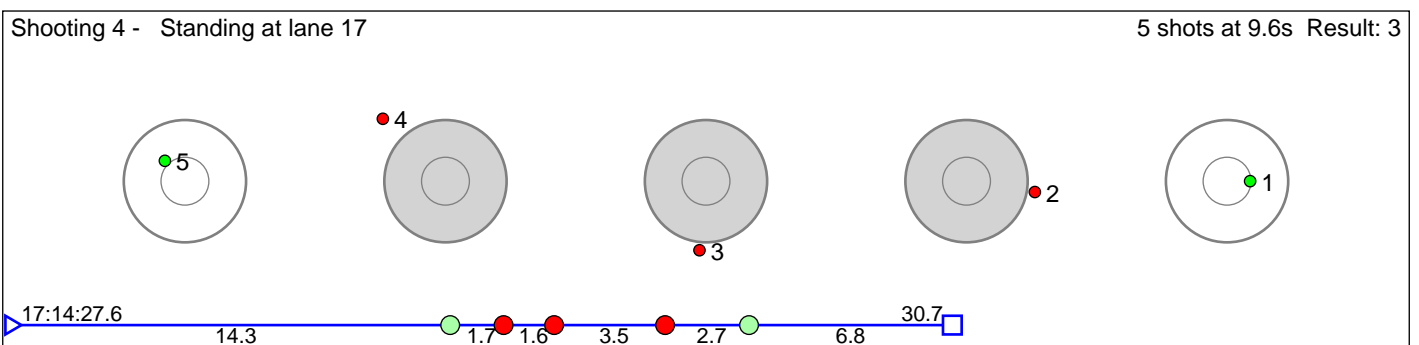
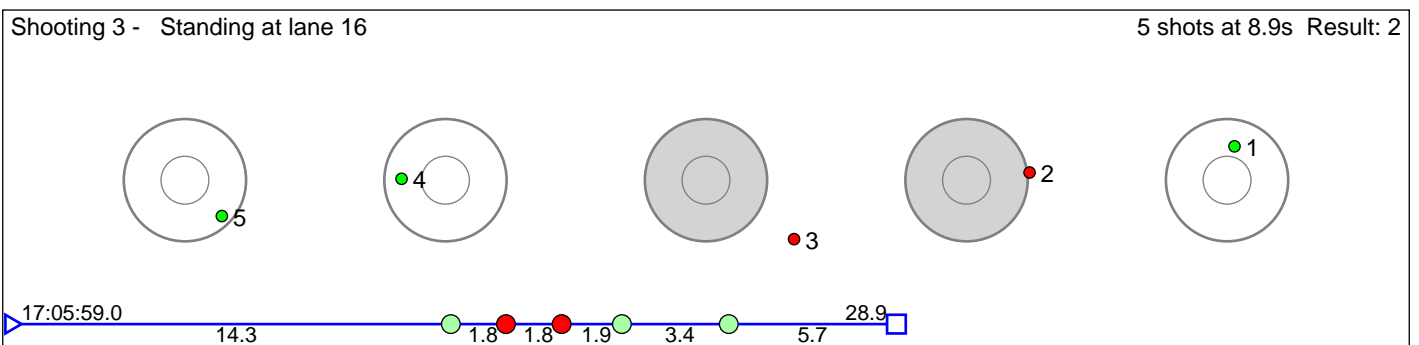
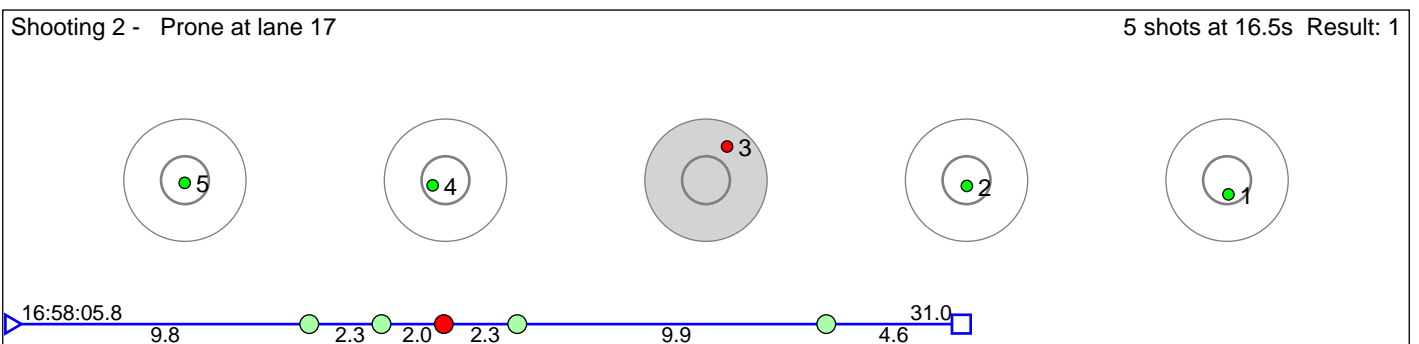
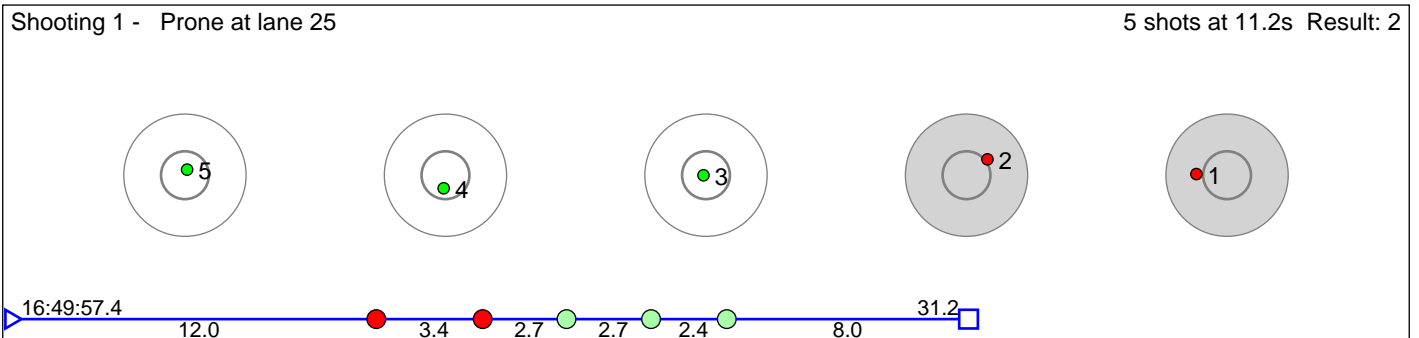

**Disclaimer:**

These results are unofficial since only the final output from the timing system can provide complete and correct competition results. The graphic plot of each series, presents the location of the shots on each of the five targets. Please observe that the accuracy of the plotting has some limitations due to image resolution and/or printer quality.



# 566 Solum Kristoffer Schulz

Simostranda IL

Result: 11

Shooting 1 - Prone at lane 26 5 shots at 21.4s Result: 4

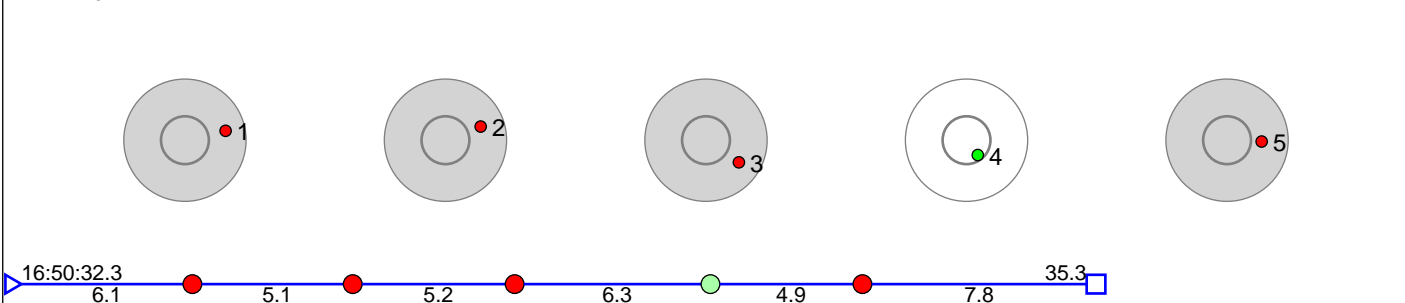

Shooting 2 - Prone at lane 25 5 shots at 16.9s Result: 2

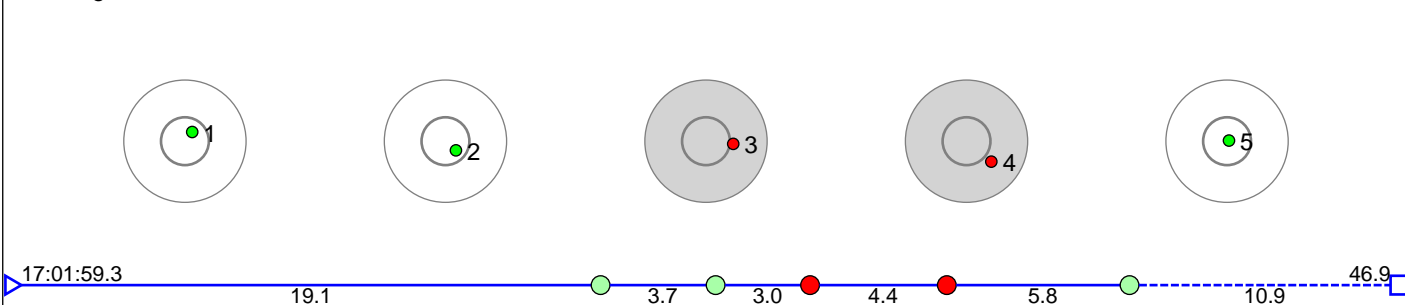

Shooting 3 - Standing at lane 25 5 shots at 14.9s Result: 2

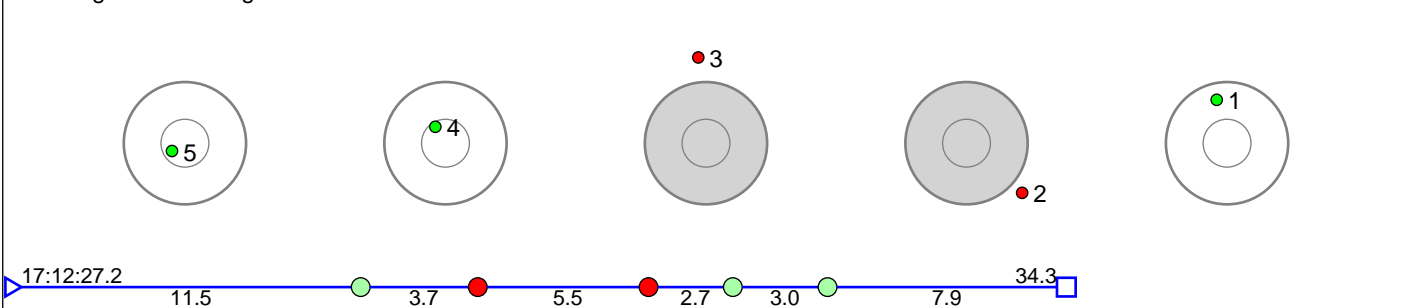

Shooting 4 - Standing at lane 25 5 shots at 18.6s Result: 3

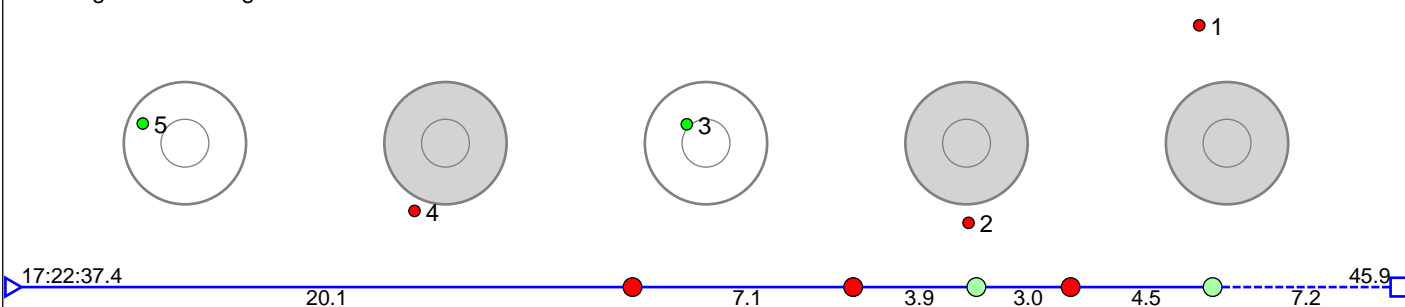

**Disclaimer:**

These results are unofficial since only the final output from the timing system can provide complete and correct competition results. The graphic plot of each series, presents the location of the shots on each of the five targets. Please observe that the accuracy of the plotting has some limitations due to image resolution and/or printer quality.