

4

Result: 10

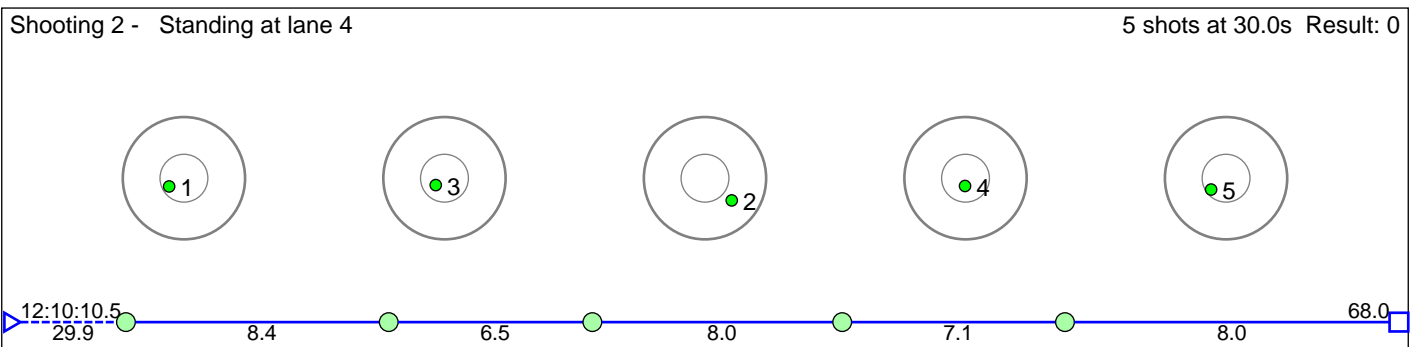
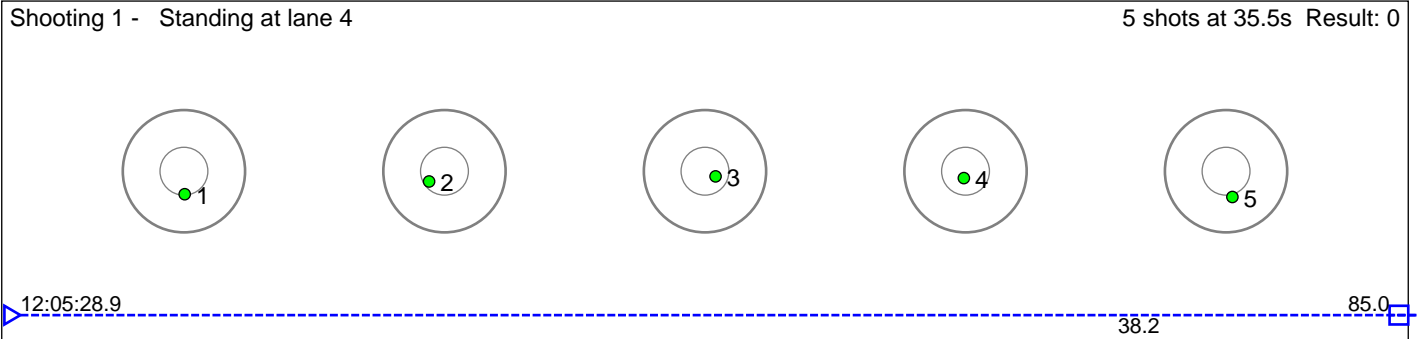

Disclaimer:

These results are unofficial since only the final output from the timing system can provide complete and correct competition results. The graphic plot of each series, presents the location of the shots on each of the five targets. Please observe that the accuracy of the plotting has some limitations due to image resolution and/or printer quality.

5 Norheim Asbjørn

Kvam Langrenn- og Skiskyttarklubb

Result: 11

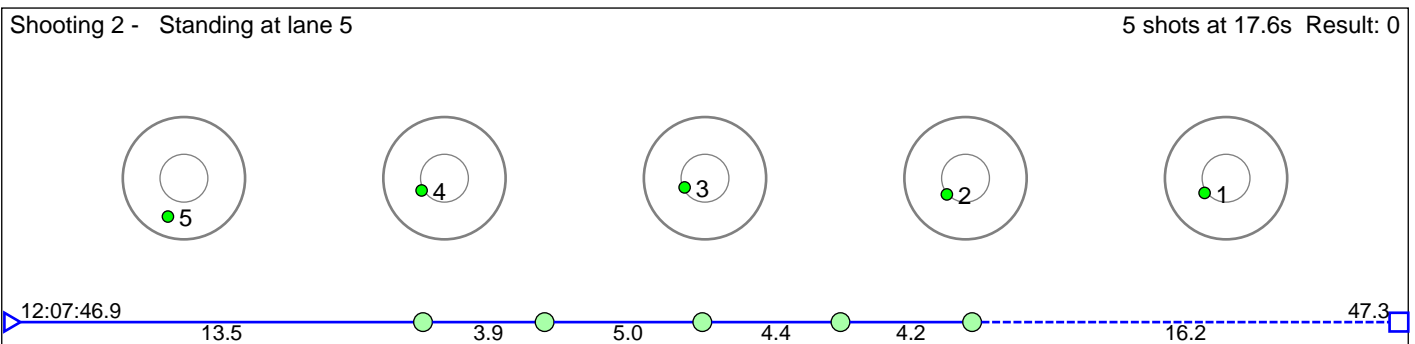
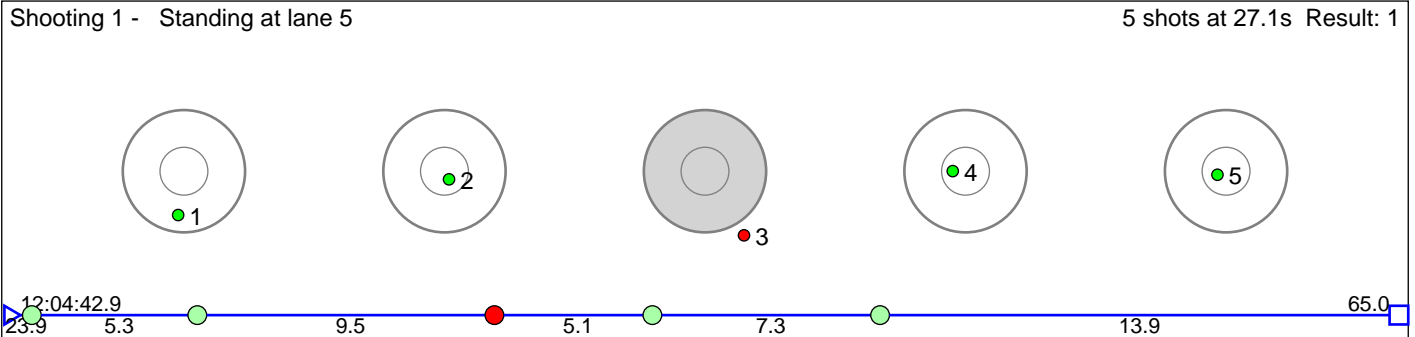

Disclaimer:

These results are unofficial since only the final output from the timing system can provide complete and correct competition results. The graphic plot of each series, presents the location of the shots on each of the five targets. Please observe that the accuracy of the plotting has some limitations due to image resolution and/or printer quality.

6 Gjerme Markus Haugen

Voss Skiskytterlag

Result: 13

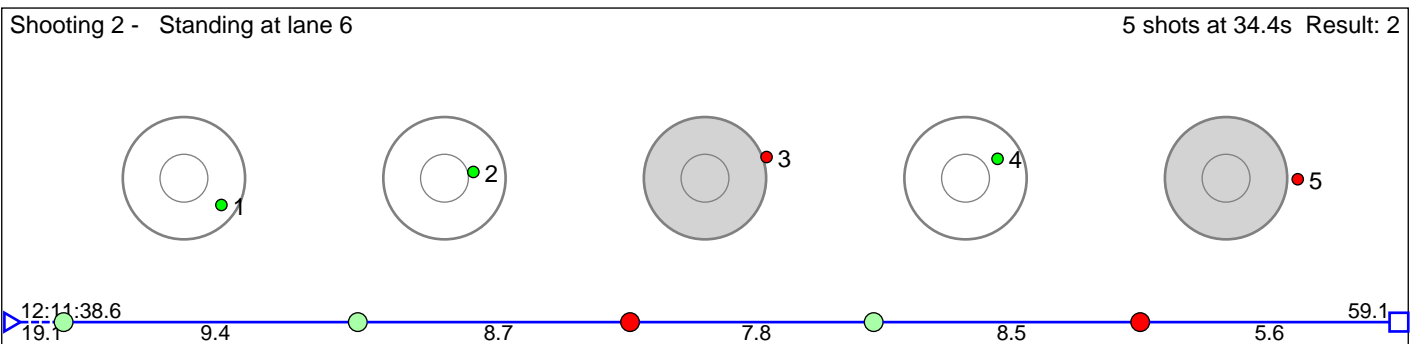
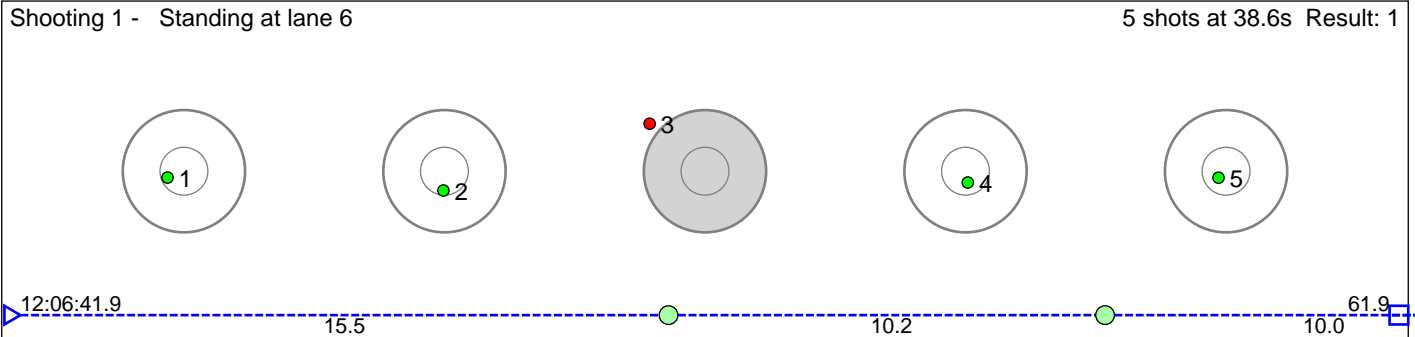

Disclaimer:

These results are unofficial since only the final output from the timing system can provide complete and correct competition results. The graphic plot of each series, presents the location of the shots on each of the five targets. Please observe that the accuracy of the plotting has some limitations due to image resolution and/or printer quality.

7 SÃderstrÃm Theodor

Fana IL

Result: 10

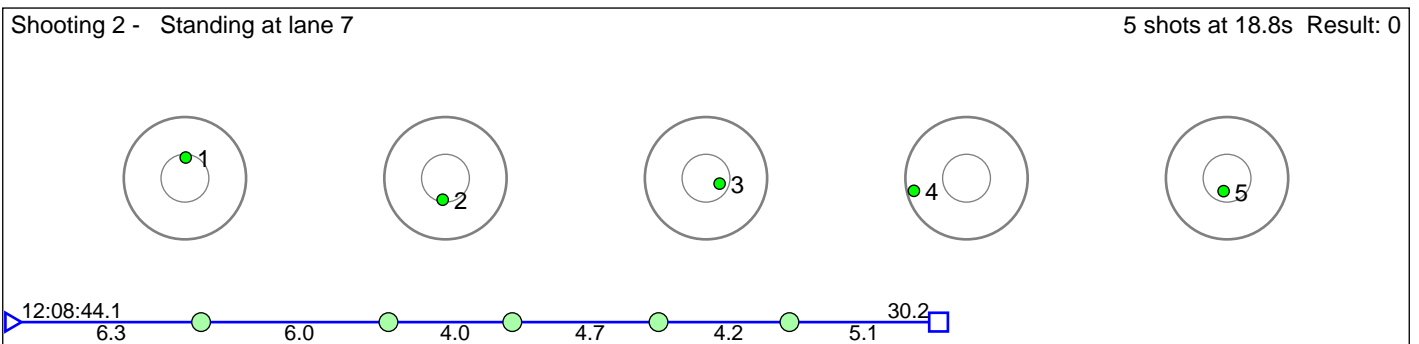
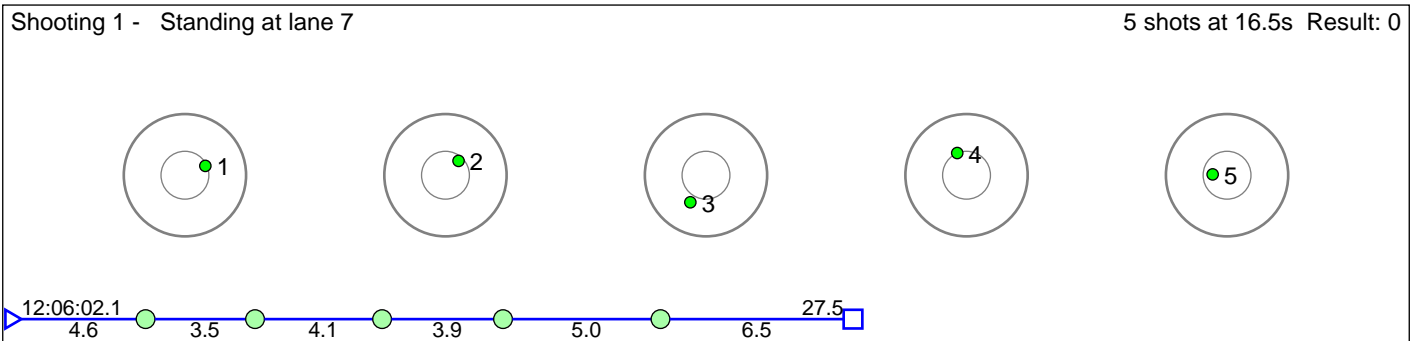

Disclaimer:

These results are unofficial since only the final output from the timing system can provide complete and correct competition results. The graphic plot of each series, presents the location of the shots on each of the five targets. Please observe that the accuracy of the plotting has some limitations due to image resolution and/or printer quality.

8 Fenne Emilie

Voss Skiskytterlag

Result: 12

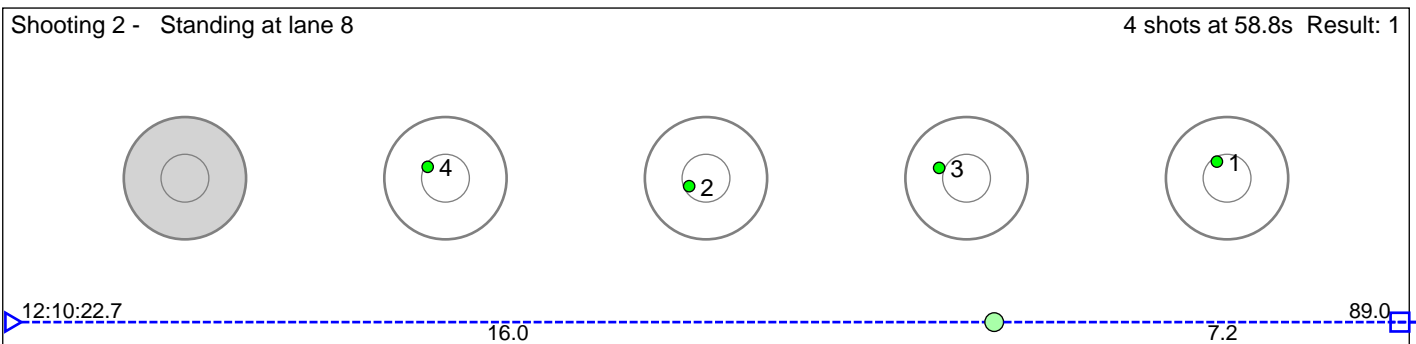
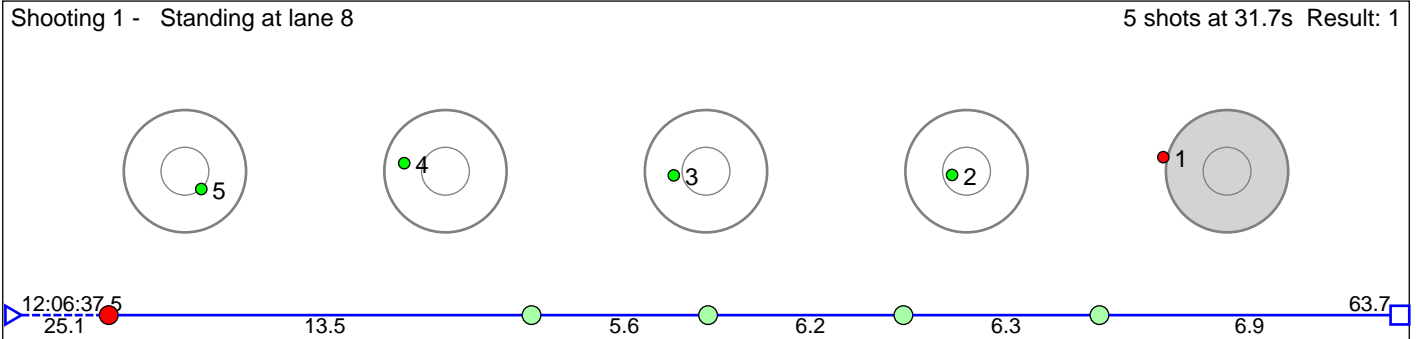

Disclaimer:

These results are unofficial since only the final output from the timing system can provide complete and correct competition results. The graphic plot of each series, presents the location of the shots on each of the five targets. Please observe that the accuracy of the plotting has some limitations due to image resolution and/or printer quality.

9 Skagen Mathias Fosse

Vik IL

Result: 11

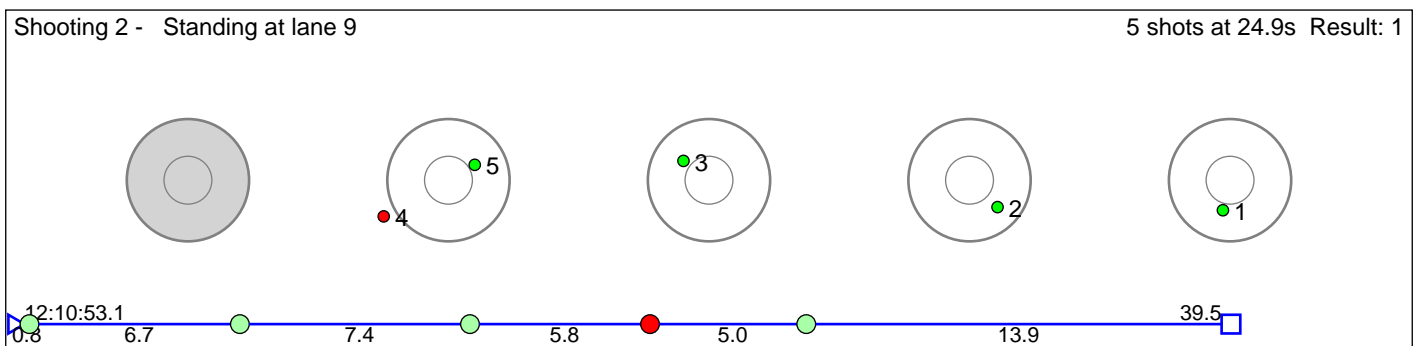
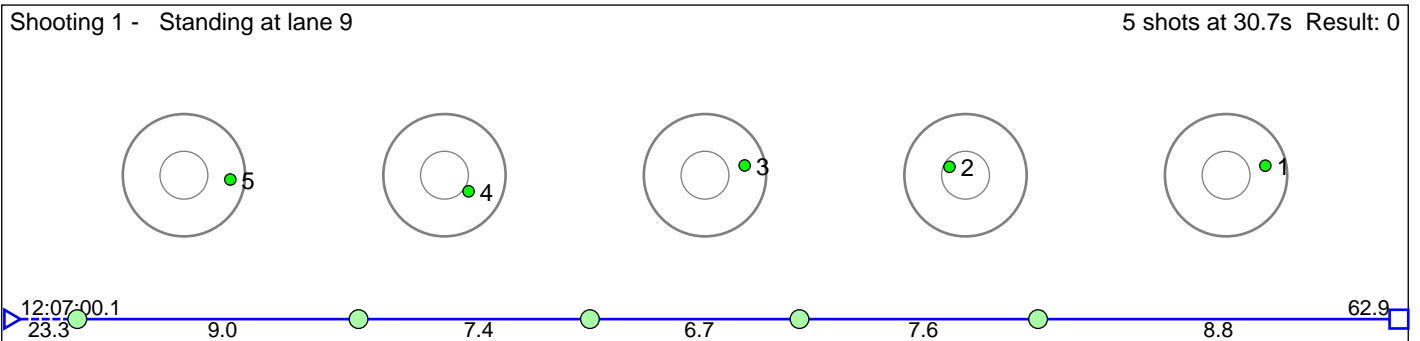

Disclaimer:

These results are unofficial since only the final output from the timing system can provide complete and correct competition results. The graphic plot of each series, presents the location of the shots on each of the five targets. Please observe that the accuracy of the plotting has some limitations due to image resolution and/or printer quality.

10 VestbÅ, Sunniva Henriksen

Kvam Langrenn- og Skiskyttarklubb

Result: 10

Shooting 1 - Standing at lane 10 5 shots at 16.1s Result: 0

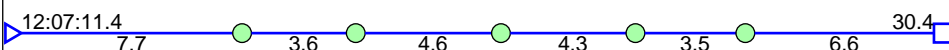
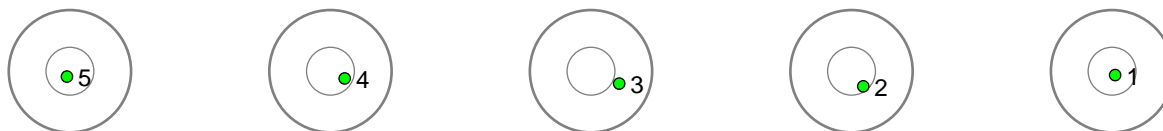

Shooting 2 - Standing at lane 10 5 shots at 17.3s Result: 0

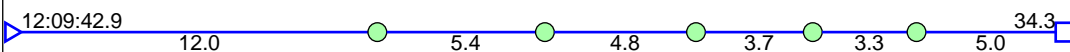
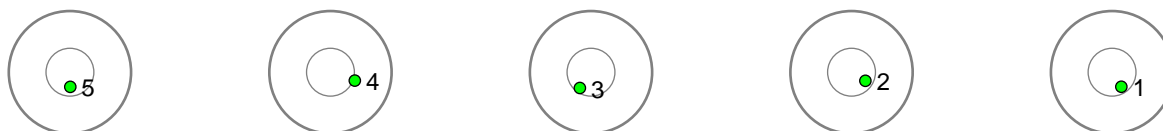

Disclaimer:

These results are unofficial since only the final output from the timing system can provide complete and correct competition results. The graphic plot of each series, presents the location of the shots on each of the five targets. Please observe that the accuracy of the plotting has some limitations due to image resolution and/or printer quality.

11 Nesbø, Tora Opheim

Voss Skiskytterlag

Result: 10

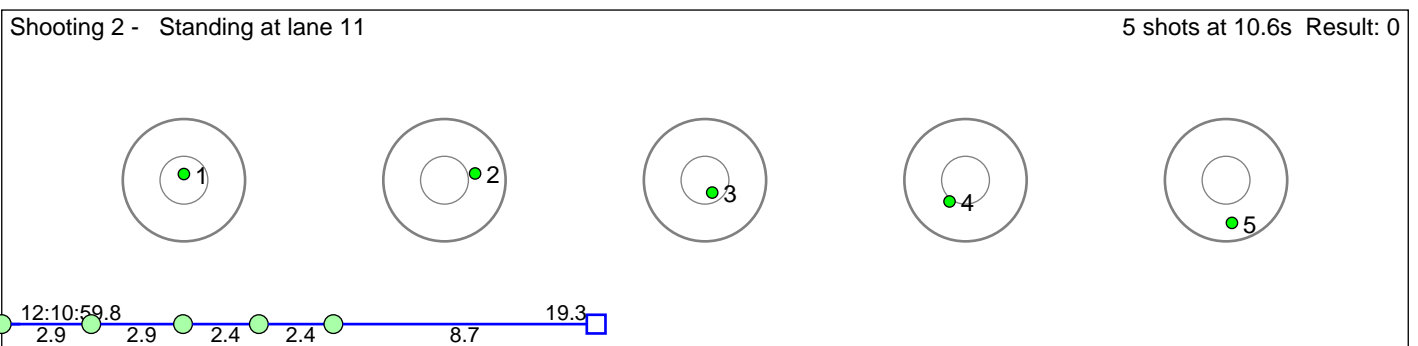
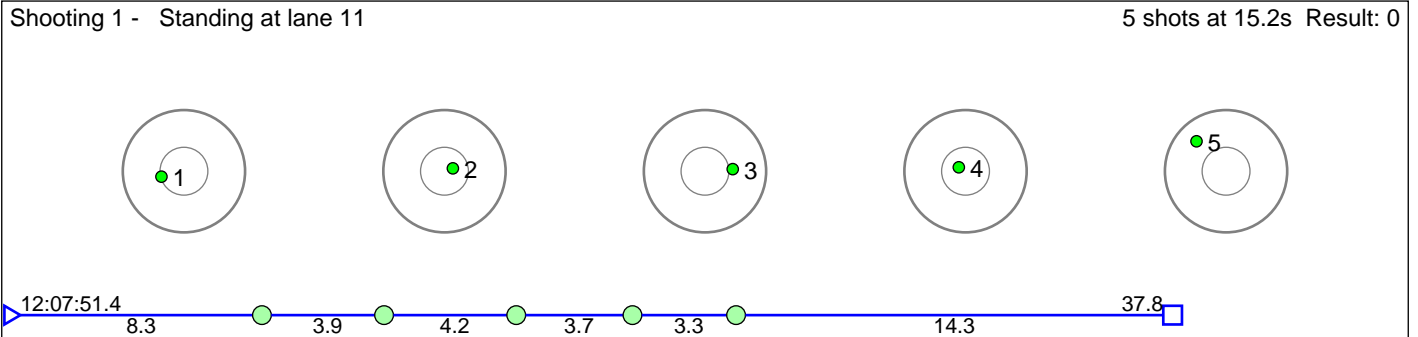

Disclaimer:

These results are unofficial since only the final output from the timing system can provide complete and correct competition results. The graphic plot of each series, presents the location of the shots on each of the five targets. Please observe that the accuracy of the plotting has some limitations due to image resolution and/or printer quality.

12 Vik Tage Tennebekk

Voss IL

Result: 12

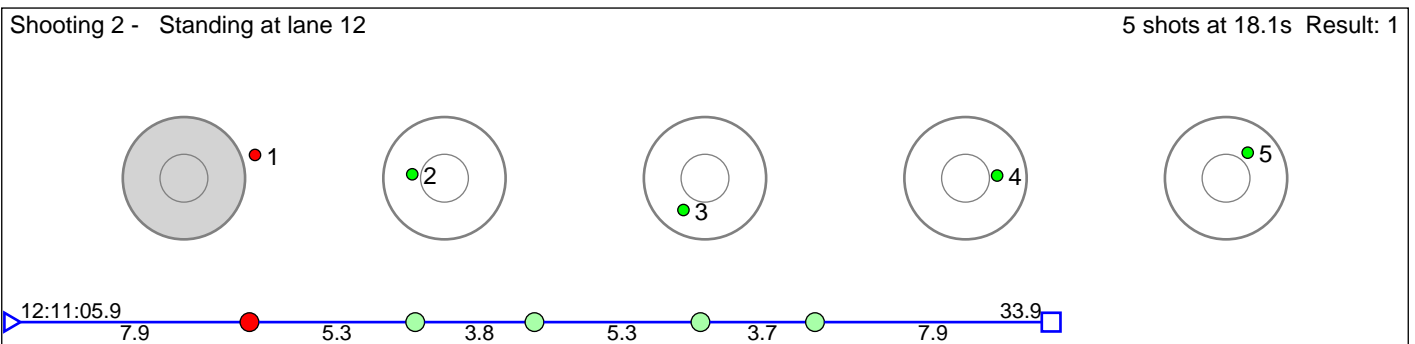
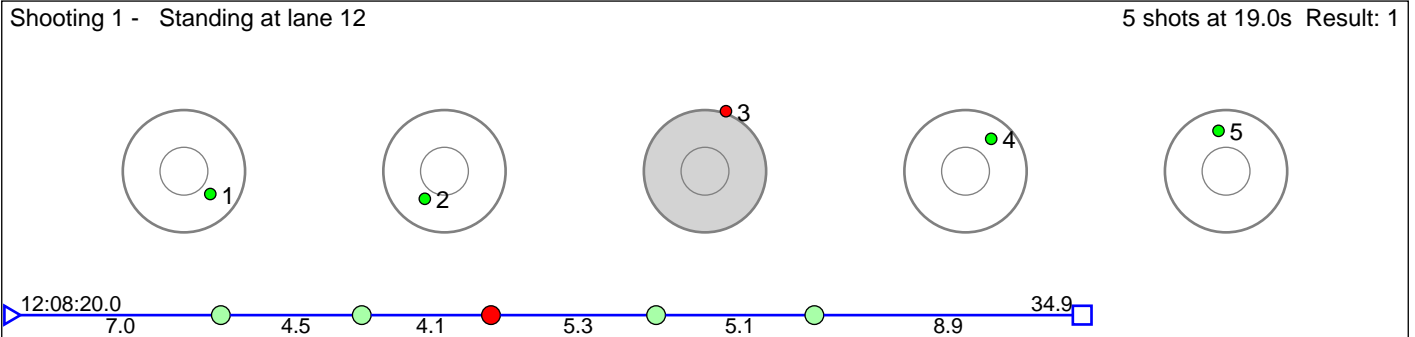

Disclaimer:

These results are unofficial since only the final output from the timing system can provide complete and correct competition results. The graphic plot of each series, presents the location of the shots on each of the five targets. Please observe that the accuracy of the plotting has some limitations due to image resolution and/or printer quality.

13 Hansen Ada

HÅÏlandsdal IL

Result: 10

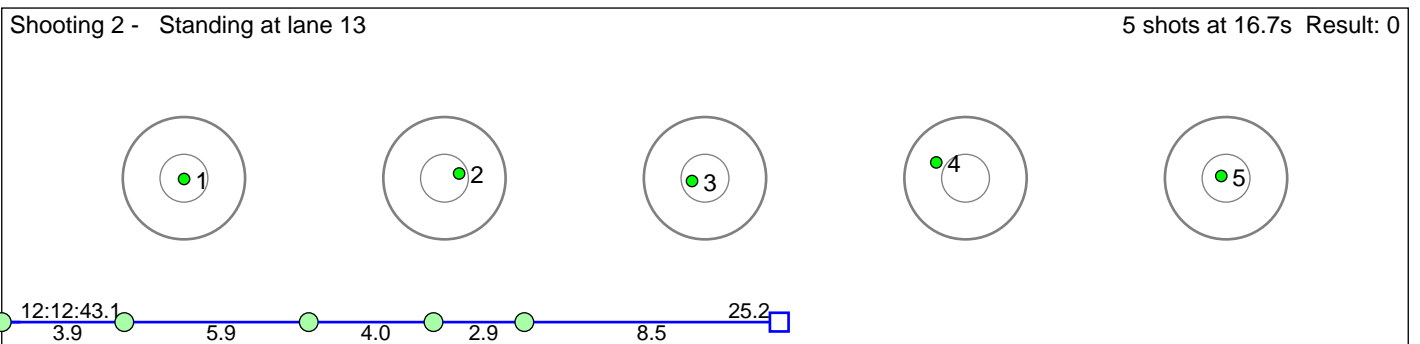
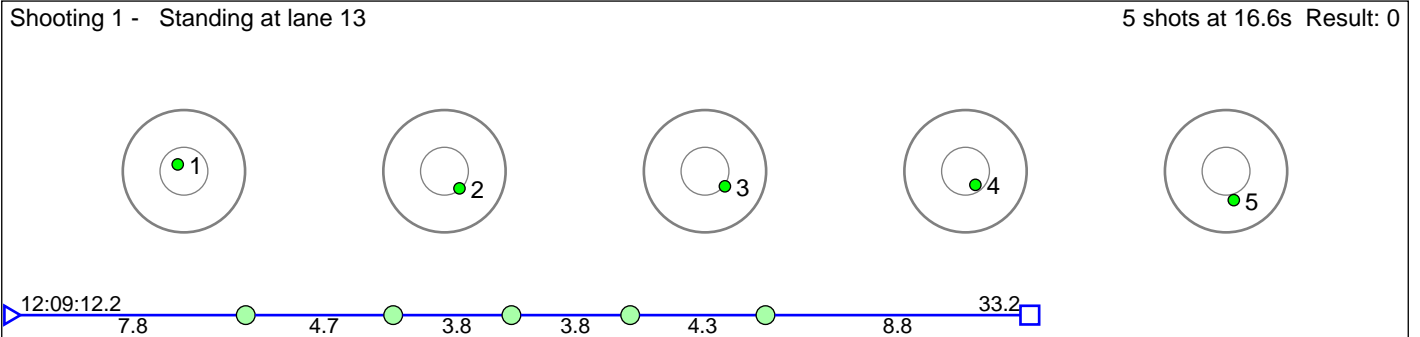

Disclaimer:

These results are unofficial since only the final output from the timing system can provide complete and correct competition results. The graphic plot of each series, presents the location of the shots on each of the five targets. Please observe that the accuracy of the plotting has some limitations due to image resolution and/or printer quality.

14 Sletner Ronja Soldal

Voss Skiskytterlag

Result: 10

Shooting 1 - Standing at lane 14 5 shots at 37.2s Result: 0

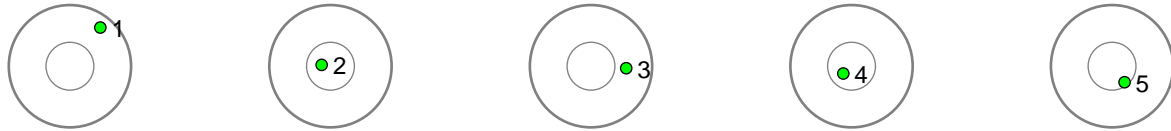

Shooting 2 - Standing at lane 14 5 shots at 47.8s Result: 0

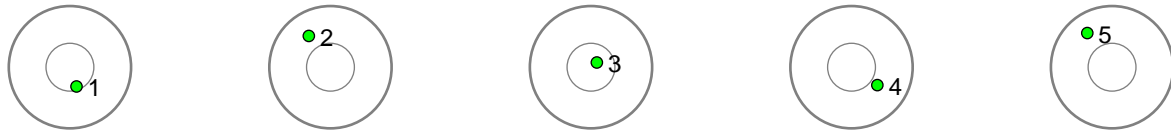

Disclaimer:

These results are unofficial since only the final output from the timing system can provide complete and correct competition results. The graphic plot of each series, presents the location of the shots on each of the five targets. Please observe that the accuracy of the plotting has some limitations due to image resolution and/or printer quality.

15 Folkestad Erik Caceres

HÅÿlandsdal IL

Result: 11

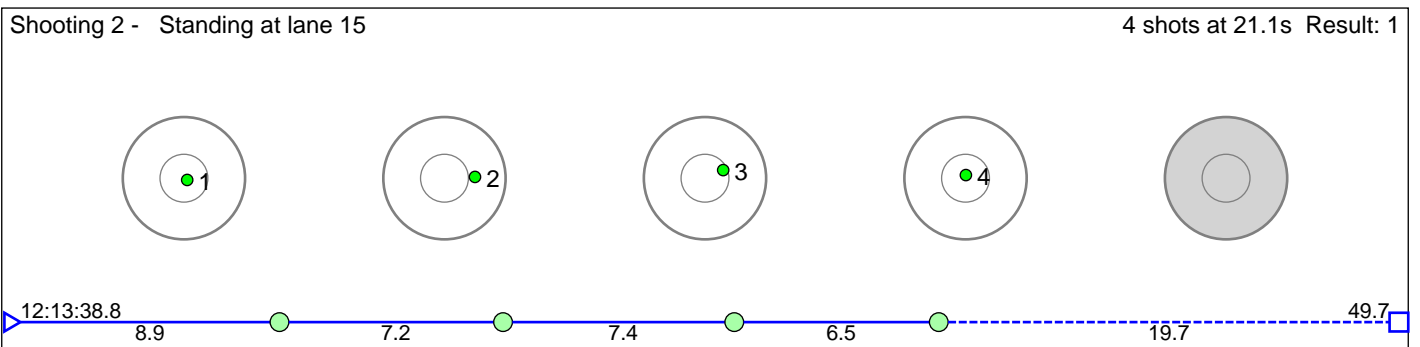
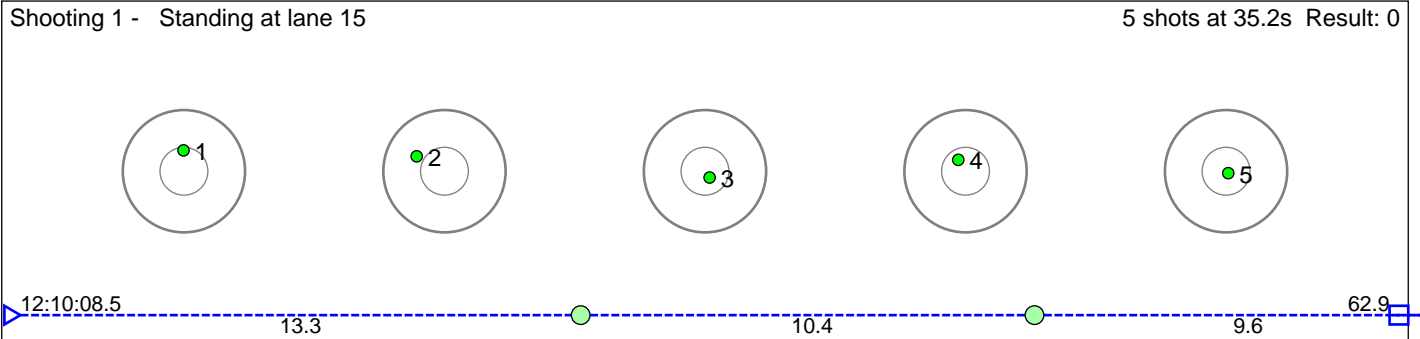

Disclaimer:

These results are unofficial since only the final output from the timing system can provide complete and correct competition results. The graphic plot of each series, presents the location of the shots on each of the five targets. Please observe that the accuracy of the plotting has some limitations due to image resolution and/or printer quality.

16 Mo Kaja HÅ, en

Kvam Langrenn- og Skiskytterklubb

Result: 10

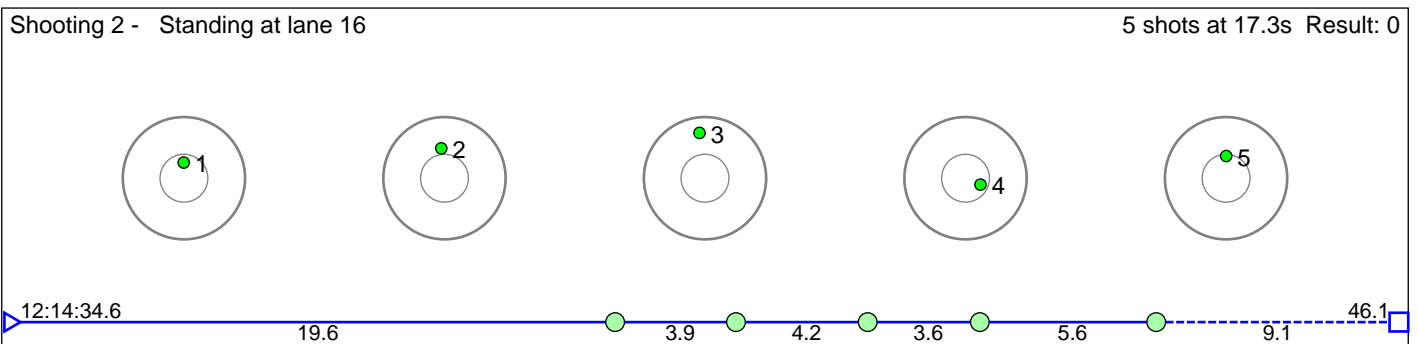
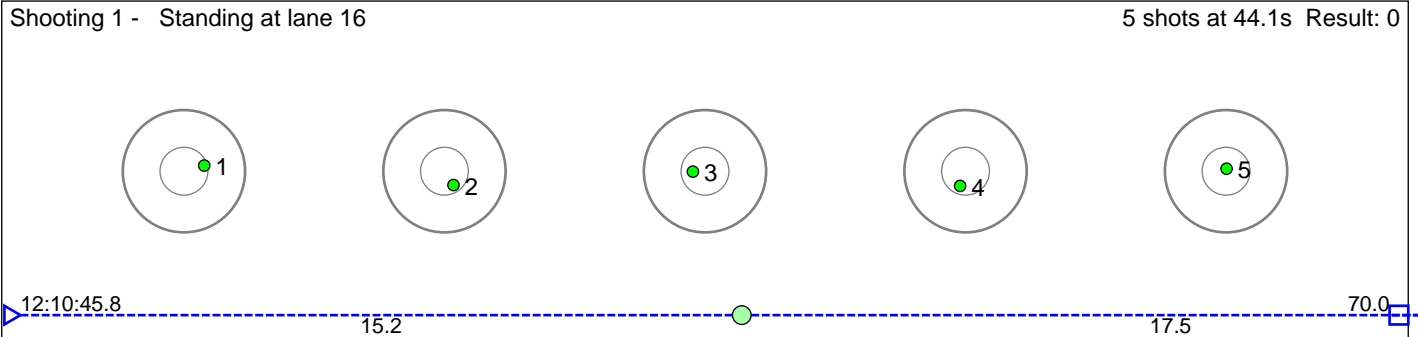

Disclaimer:

These results are unofficial since only the final output from the timing system can provide complete and correct competition results. The graphic plot of each series, presents the location of the shots on each of the five targets. Please observe that the accuracy of the plotting has some limitations due to image resolution and/or printer quality.

17 Hanto Rikke Flatlandsmo

Voss Skiskytterlag

Result: 15

Shooting 1 - Standing at lane 17 5 shots at 34.7s Result: 2

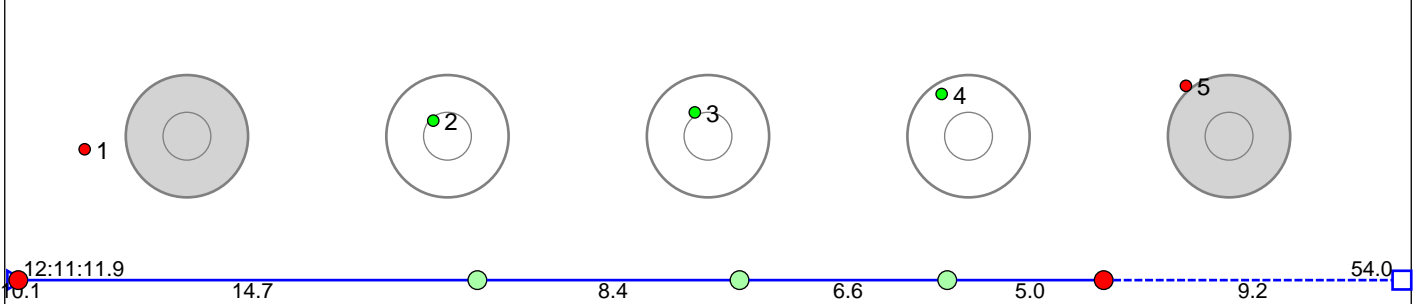

Shooting 2 - Standing at lane 17 5 shots at 40.3s Result: 3

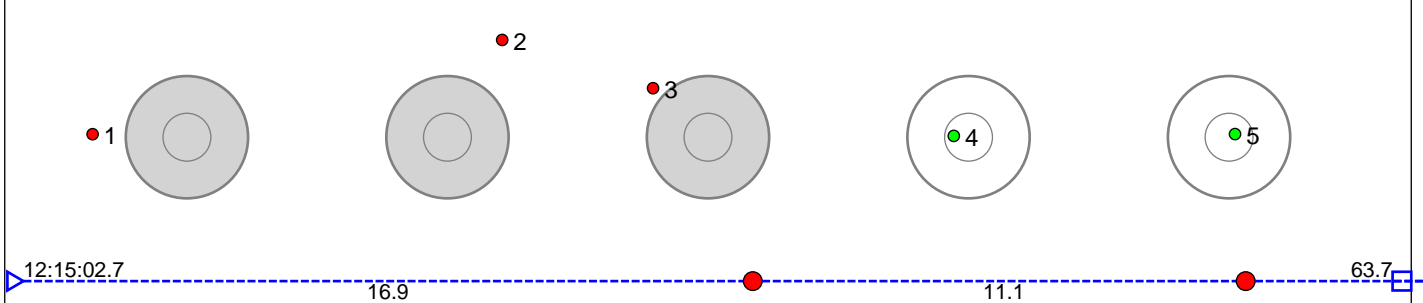

Disclaimer:

These results are unofficial since only the final output from the timing system can provide complete and correct competition results. The graphic plot of each series, presents the location of the shots on each of the five targets. Please observe that the accuracy of the plotting has some limitations due to image resolution and/or printer quality.

18 Soldal Marita Tombre

Kvam Langrenn- og Skiskyttarklubb

Result: 11

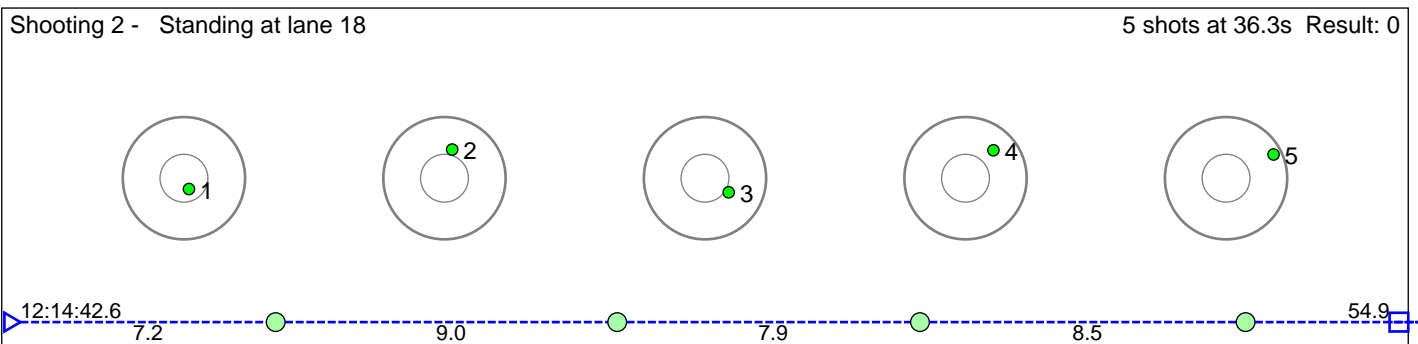
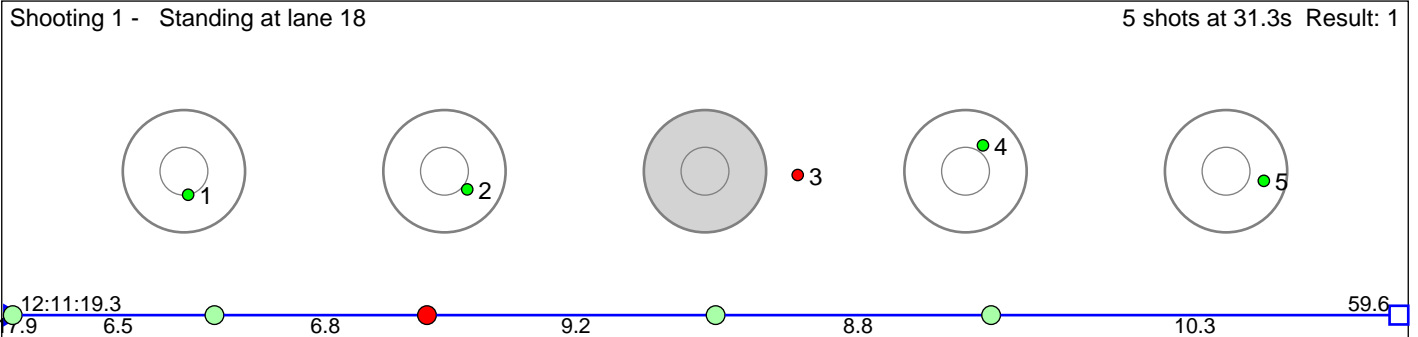

Disclaimer:

These results are unofficial since only the final output from the timing system can provide complete and correct competition results. The graphic plot of each series, presents the location of the shots on each of the five targets. Please observe that the accuracy of the plotting has some limitations due to image resolution and/or printer quality.

20 Olsen Elida Sofie

Odda IL

Result: 11

Shooting 1 - Standing at lane 20

5 shots at 45.0s Result: 1

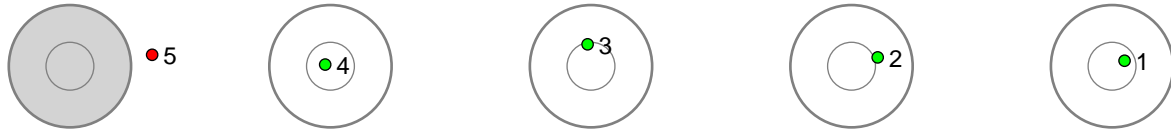

12:15:17.0

33.1

84.3

Shooting 2 - Standing at lane 20

5 shots at 39.1s Result: 0

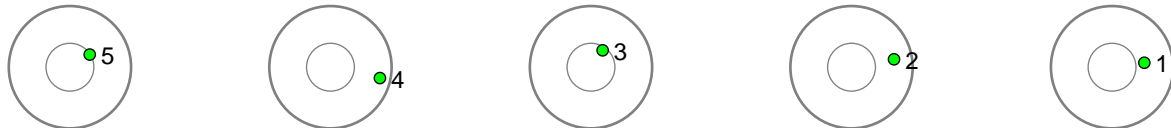

12:22:33.7

95.0

Disclaimer:

These results are unofficial since only the final output from the timing system can provide complete and correct competition results. The graphic plot of each series, presents the location of the shots on each of the five targets. Please observe that the accuracy of the plotting has some limitations due to image resolution and/or printer quality.

21

Result: 10

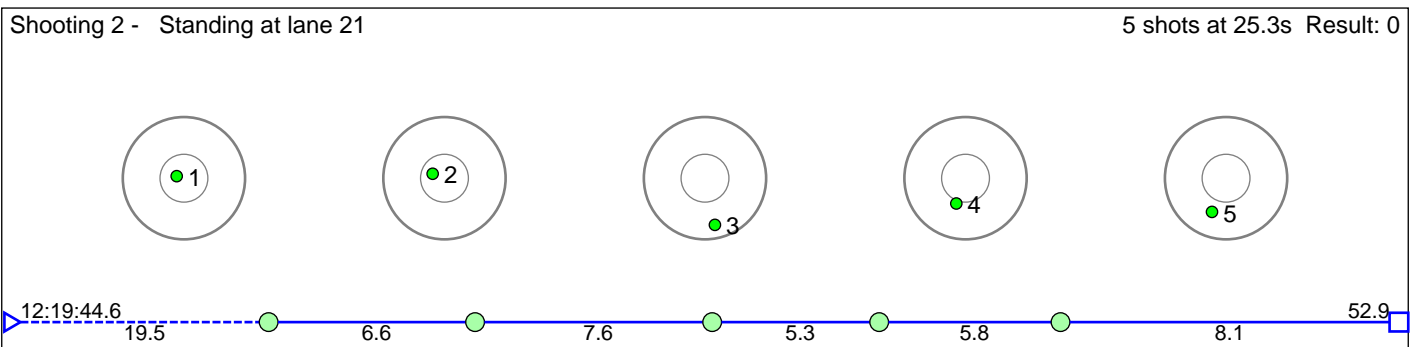
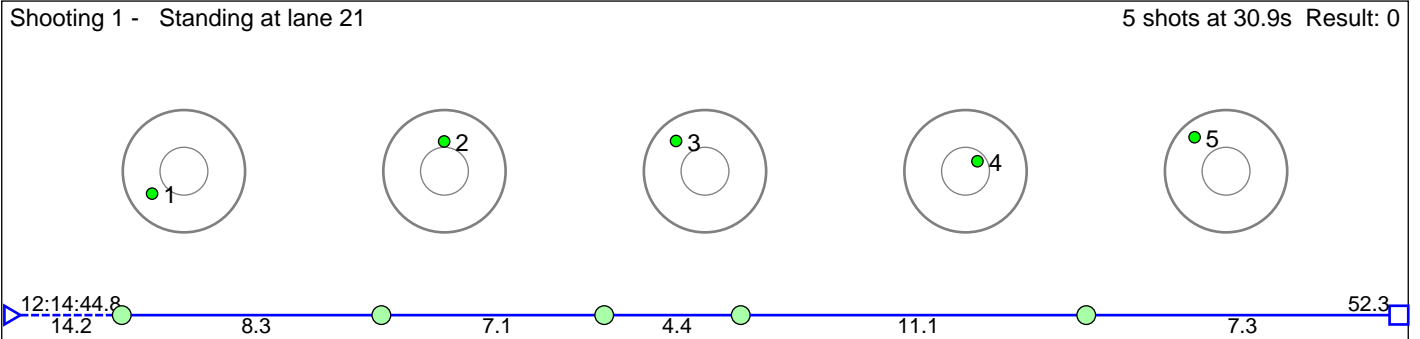

Disclaimer:

These results are unofficial since only the final output from the timing system can provide complete and correct competition results. The graphic plot of each series, presents the location of the shots on each of the five targets. Please observe that the accuracy of the plotting has some limitations due to image resolution and/or printer quality.

26 SÅiten Unn

Voss Skiskytterlag

Result: 17

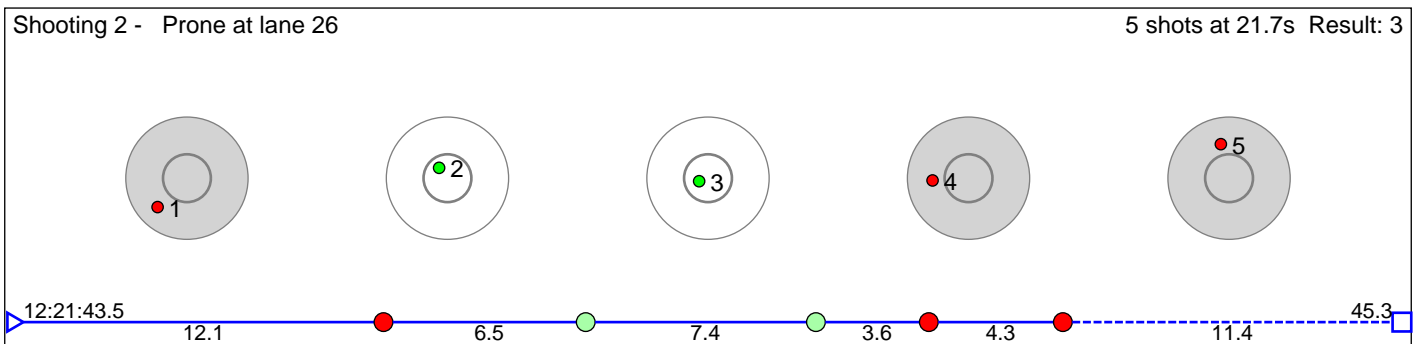
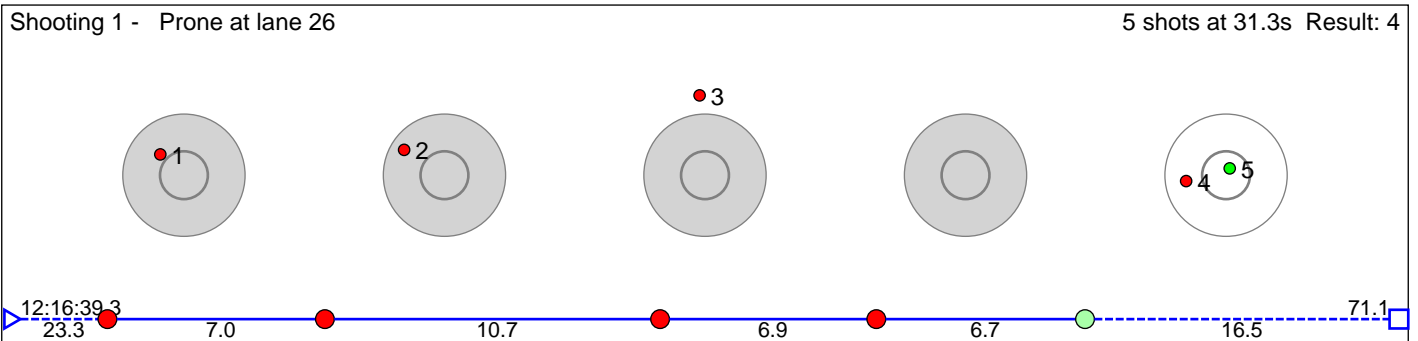

Disclaimer:

These results are unofficial since only the final output from the timing system can provide complete and correct competition results. The graphic plot of each series, presents the location of the shots on each of the five targets. Please observe that the accuracy of the plotting has some limitations due to image resolution and/or printer quality.

27 Fonneland Maylinn Hellene

Kvam Langrenn- og Skiskyttarklubb

Result: 11

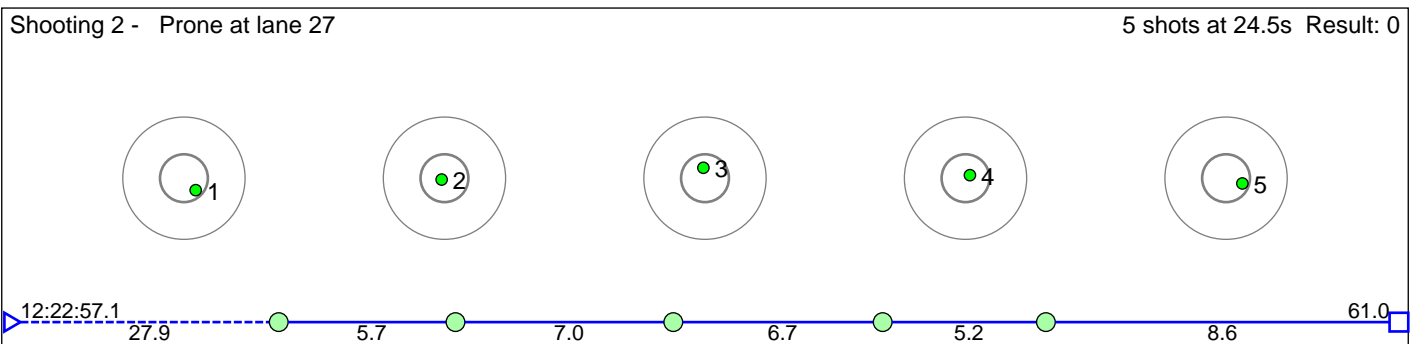
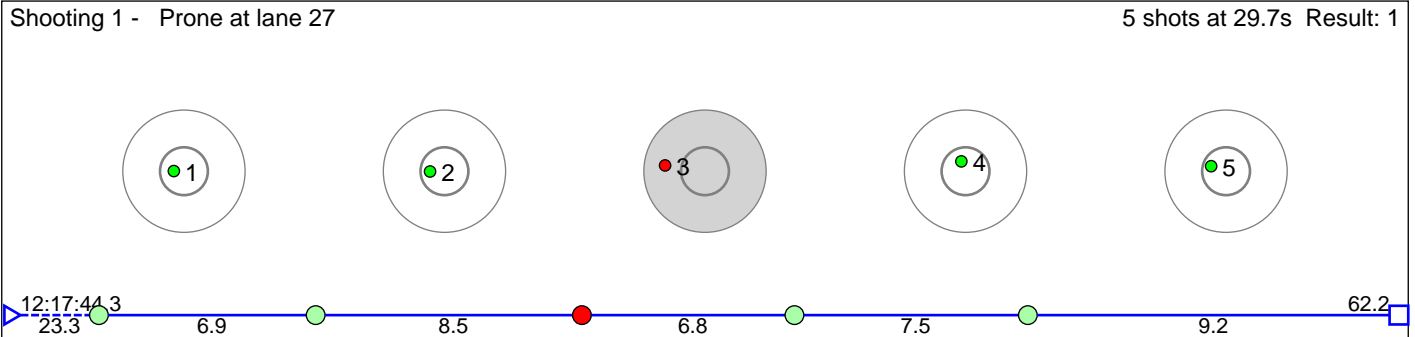

Disclaimer:

These results are unofficial since only the final output from the timing system can provide complete and correct competition results. The graphic plot of each series, presents the location of the shots on each of the five targets. Please observe that the accuracy of the plotting has some limitations due to image resolution and/or printer quality.

28 Sleen-Gullbr   Nicoline

Voss Skiskytterlag

Result: 16

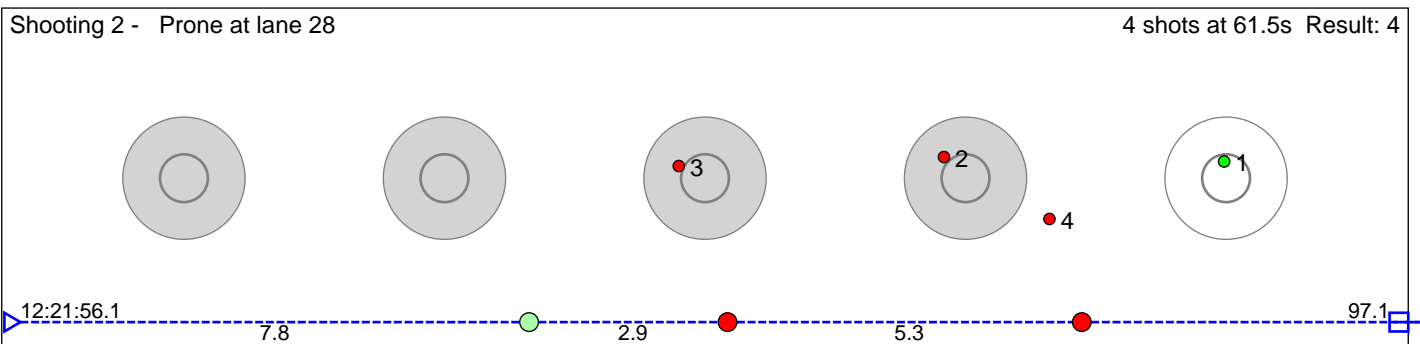
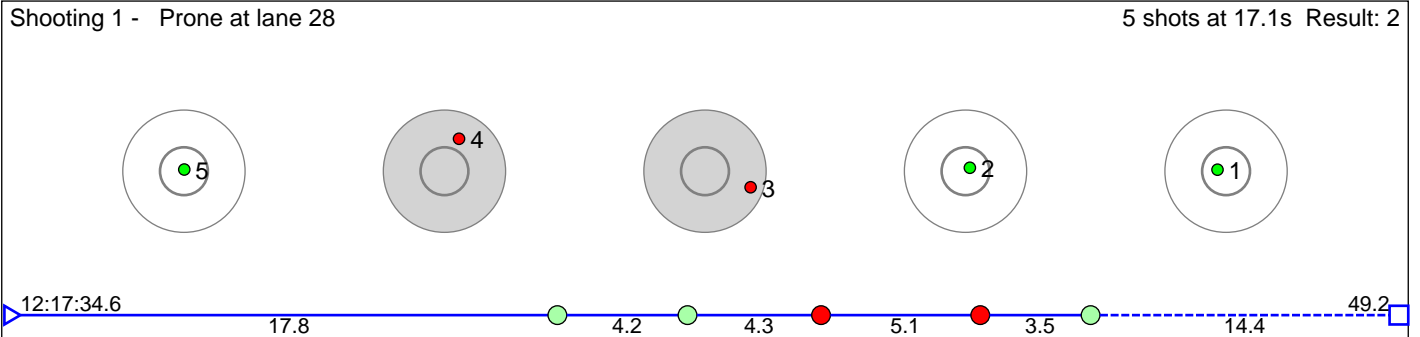

Disclaimer:

These results are unofficial since only the final output from the timing system can provide complete and correct competition results. The graphic plot of each series, presents the location of the shots on each of the five targets. Please observe that the accuracy of the plotting has some limitations due to image resolution and/or printer quality.

29 Kyrvestad Margrethe

Vik IL

Result: 11

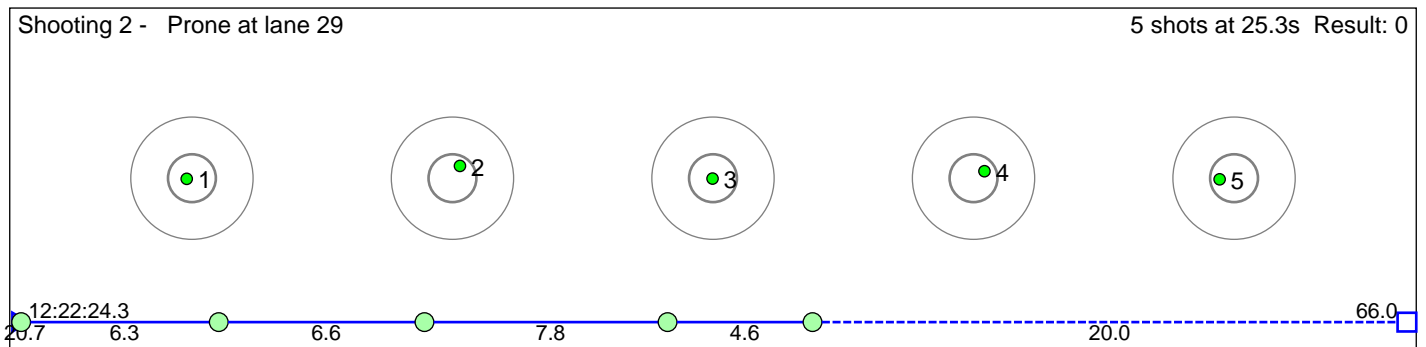
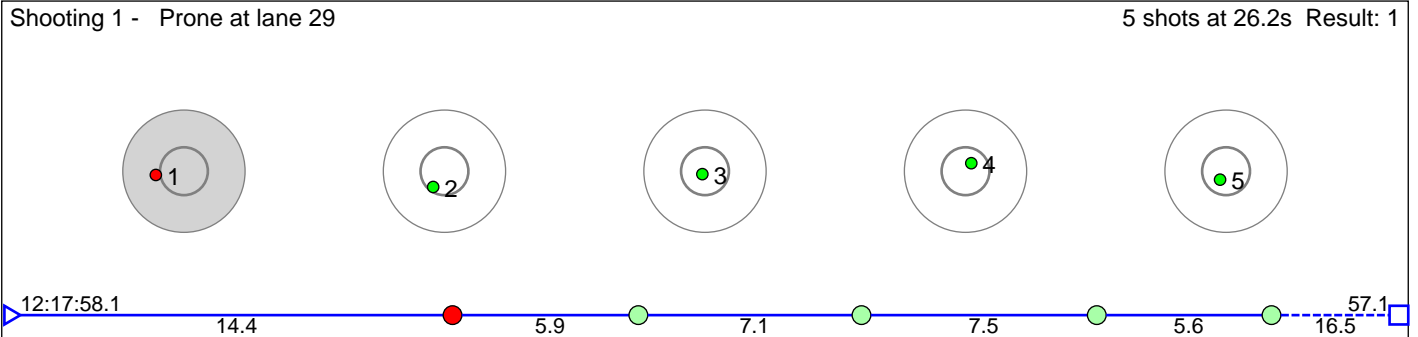

Disclaimer:

These results are unofficial since only the final output from the timing system can provide complete and correct competition results. The graphic plot of each series, presents the location of the shots on each of the five targets. Please observe that the accuracy of the plotting has some limitations due to image resolution and/or printer quality.

30 Hopsnes Ida

Fana IL

Result: 19

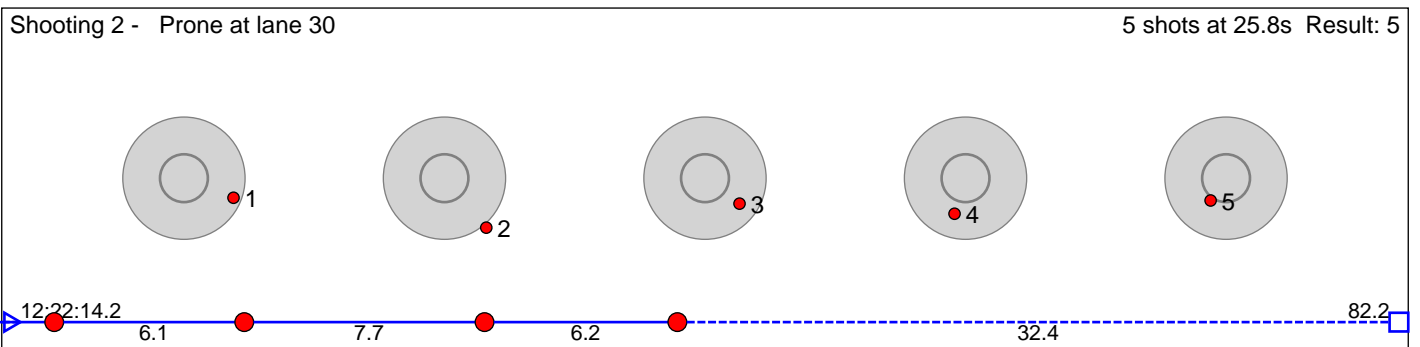
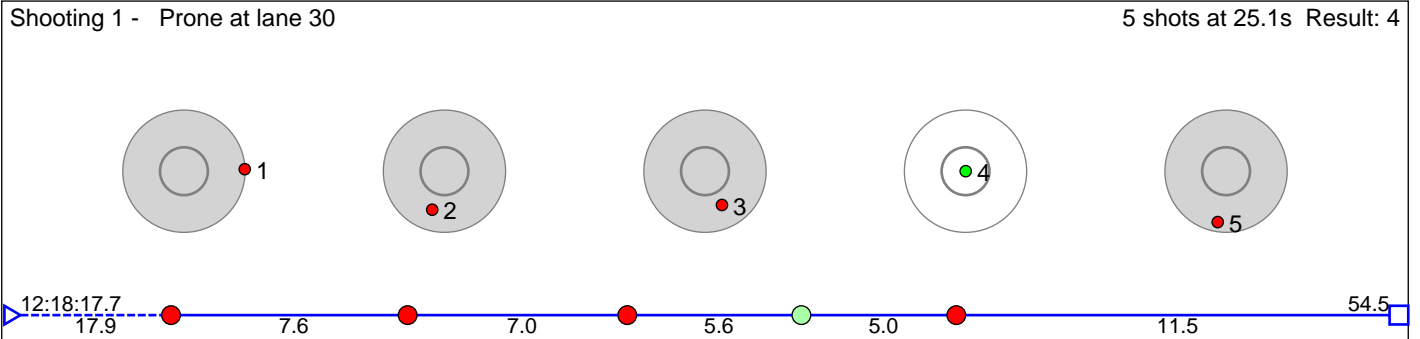

Disclaimer:

These results are unofficial since only the final output from the timing system can provide complete and correct competition results. The graphic plot of each series, presents the location of the shots on each of the five targets. Please observe that the accuracy of the plotting has some limitations due to image resolution and/or printer quality.

31 Norheim Sigrid

Kvam Langrenn- og Skiskyttarklubb

Result: 10

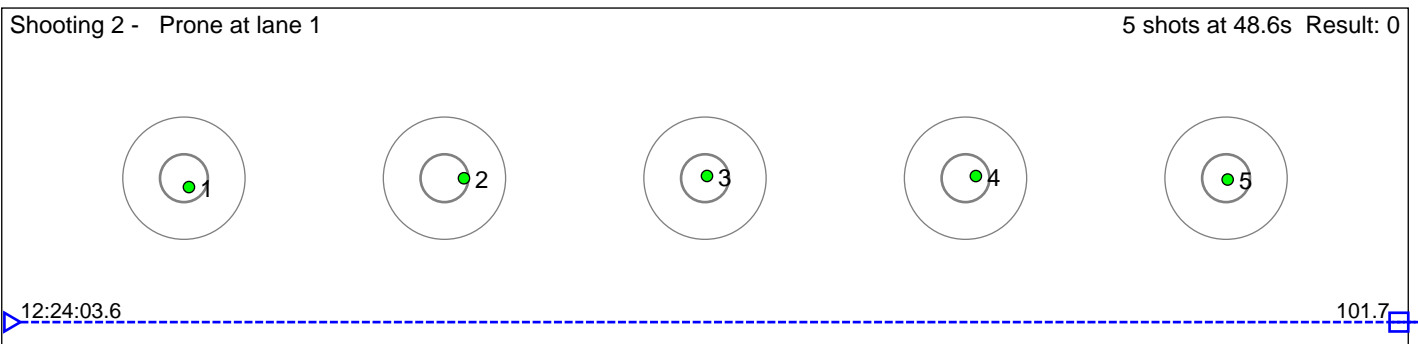
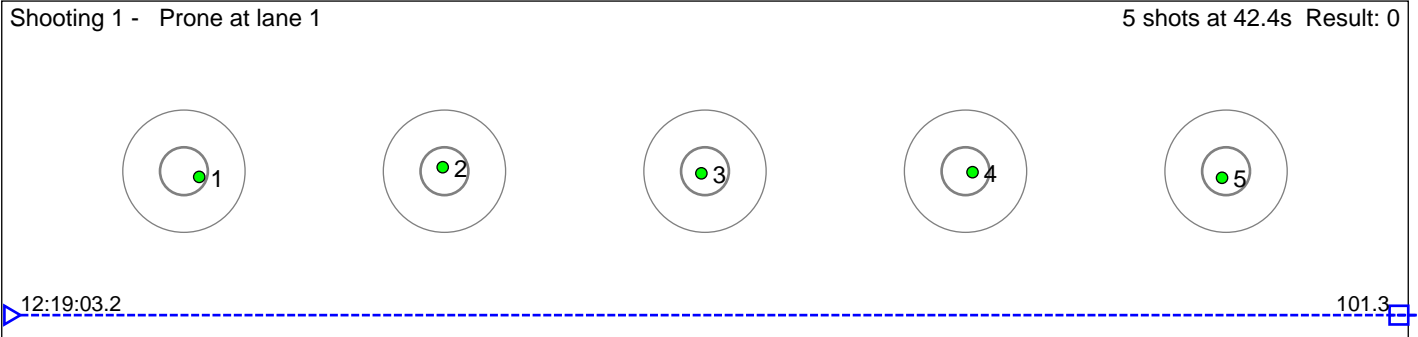

Disclaimer:

These results are unofficial since only the final output from the timing system can provide complete and correct competition results. The graphic plot of each series, presents the location of the shots on each of the five targets. Please observe that the accuracy of the plotting has some limitations due to image resolution and/or printer quality.

32 Utne Amalie Sundal

HÅÏlandsdal IL

Result: 13

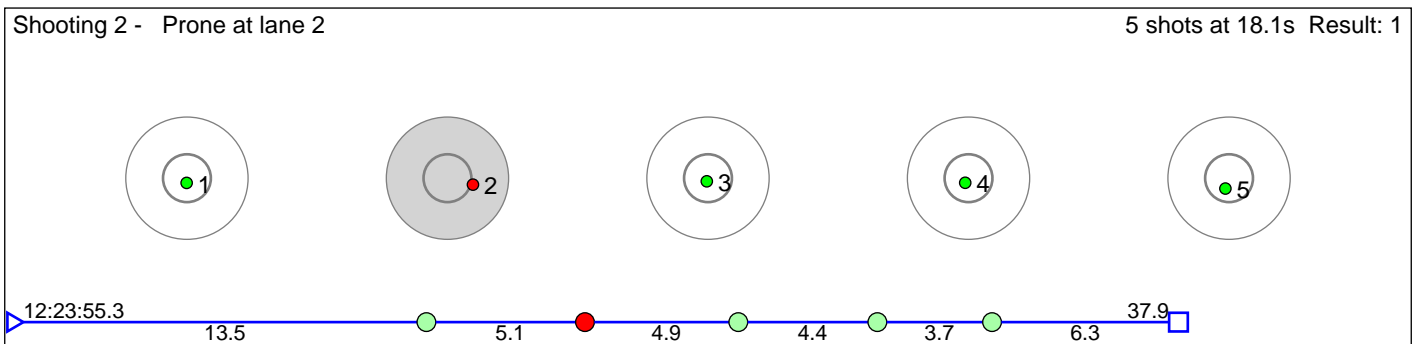
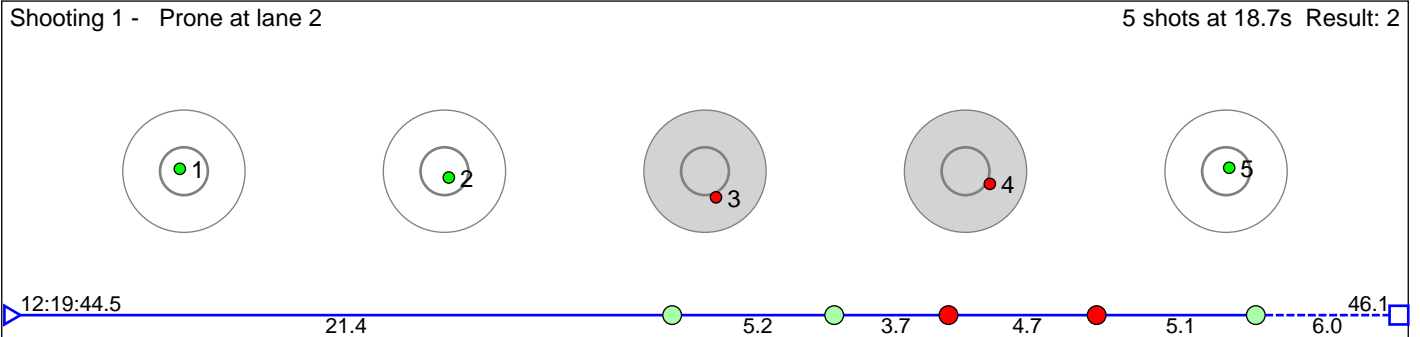

Disclaimer:

These results are unofficial since only the final output from the timing system can provide complete and correct competition results. The graphic plot of each series, presents the location of the shots on each of the five targets. Please observe that the accuracy of the plotting has some limitations due to image resolution and/or printer quality.

33 Kristiansen Sara Istad

Voss Skiskytterlag

Result: 15

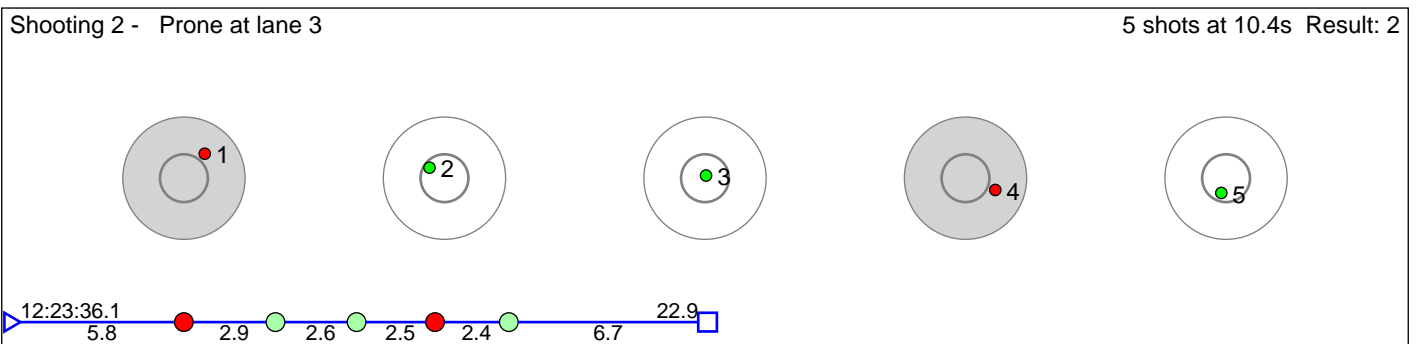
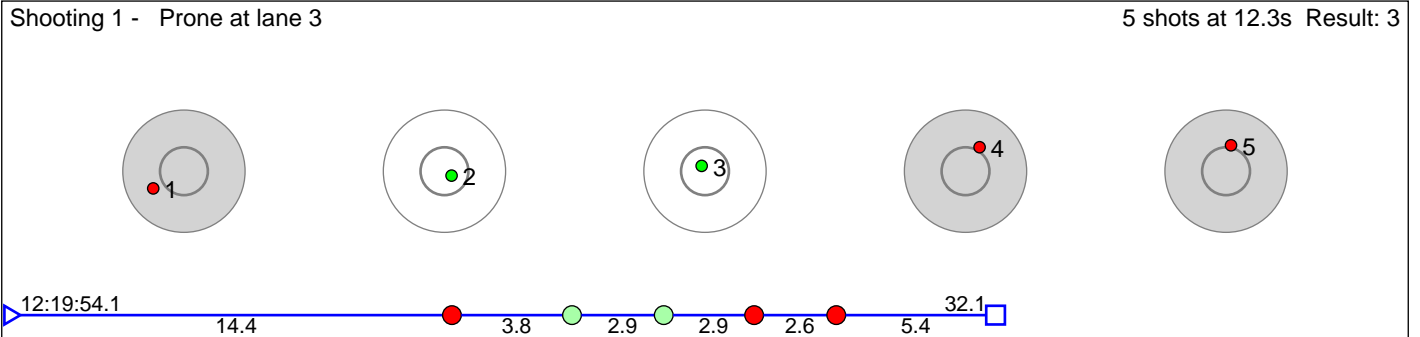

Disclaimer:

These results are unofficial since only the final output from the timing system can provide complete and correct competition results. The graphic plot of each series, presents the location of the shots on each of the five targets. Please observe that the accuracy of the plotting has some limitations due to image resolution and/or printer quality.

34 Totland Tuva Ure

Eldar IL

Result: 10

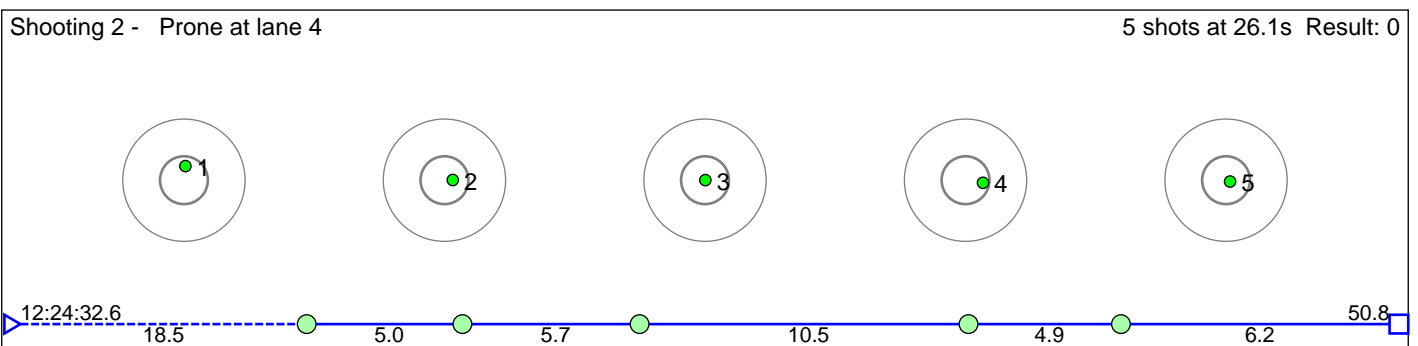
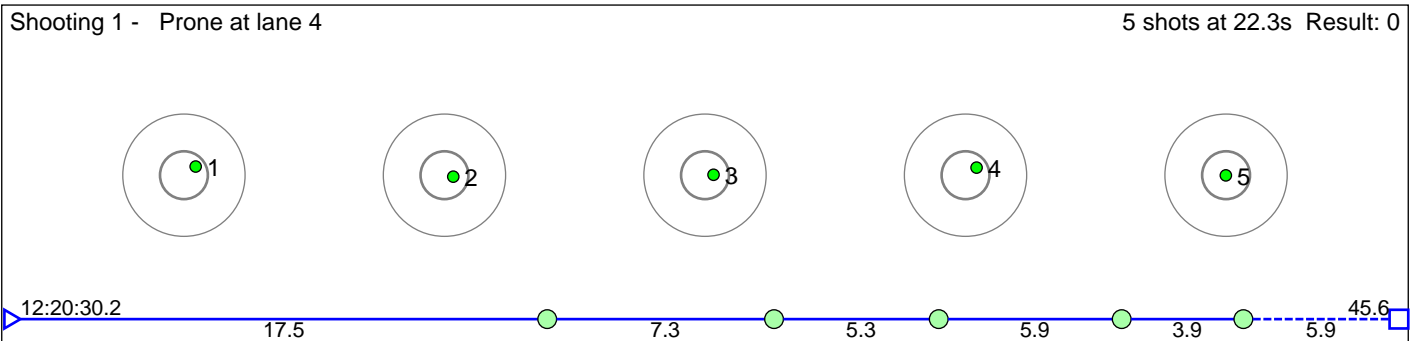

Disclaimer:

These results are unofficial since only the final output from the timing system can provide complete and correct competition results. The graphic plot of each series, presents the location of the shots on each of the five targets. Please observe that the accuracy of the plotting has some limitations due to image resolution and/or printer quality.

35 SÅ, reng Margrethe Gravelstøl

Fana IL

Result: 13

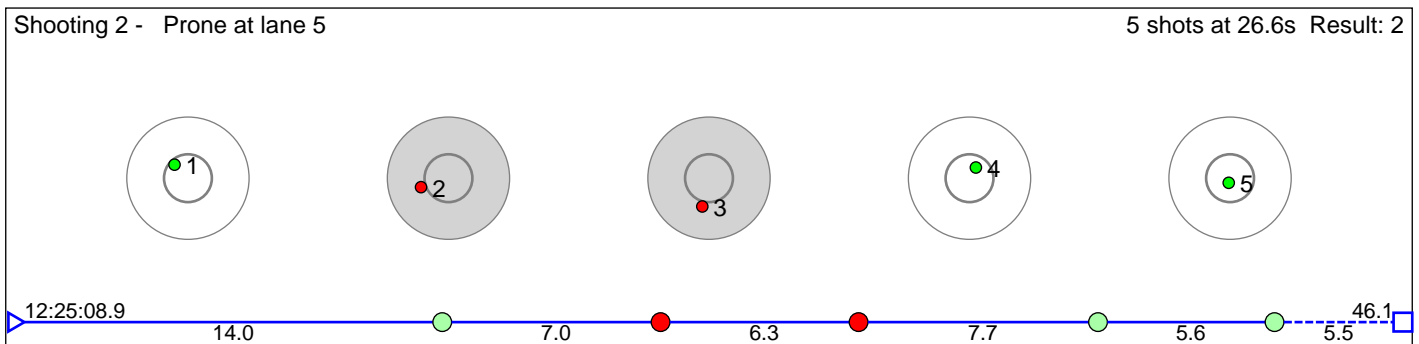
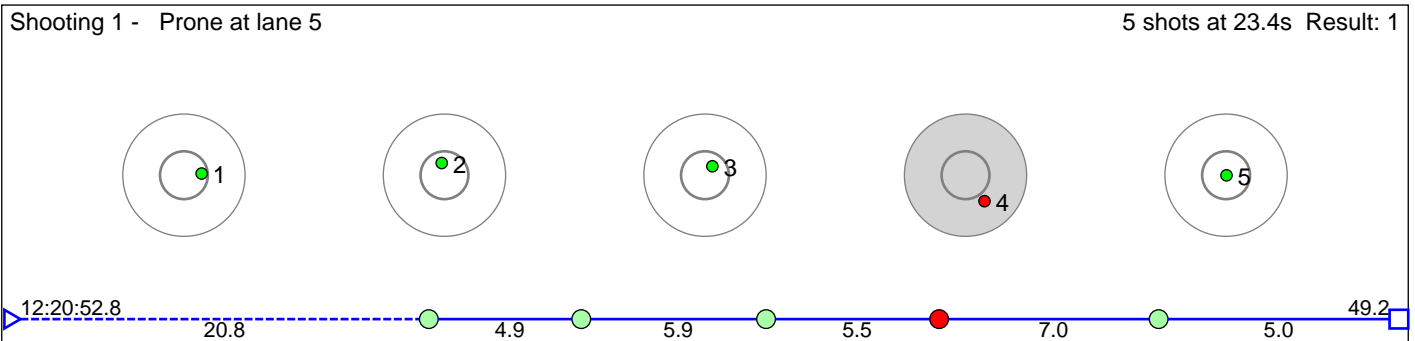

Disclaimer:

These results are unofficial since only the final output from the timing system can provide complete and correct competition results. The graphic plot of each series, presents the location of the shots on each of the five targets. Please observe that the accuracy of the plotting has some limitations due to image resolution and/or printer quality.

37 Hjortland Tomas

HÅÏlandsdal IL

Result: 12

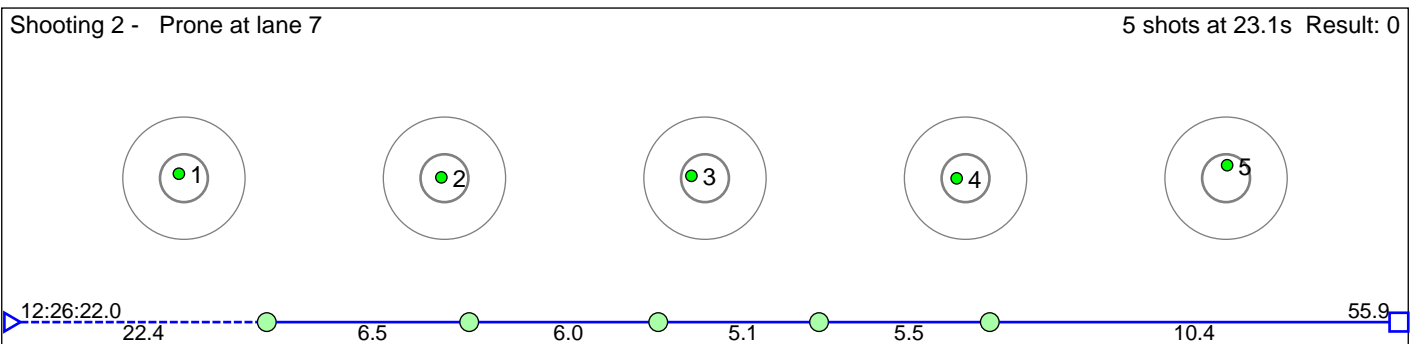
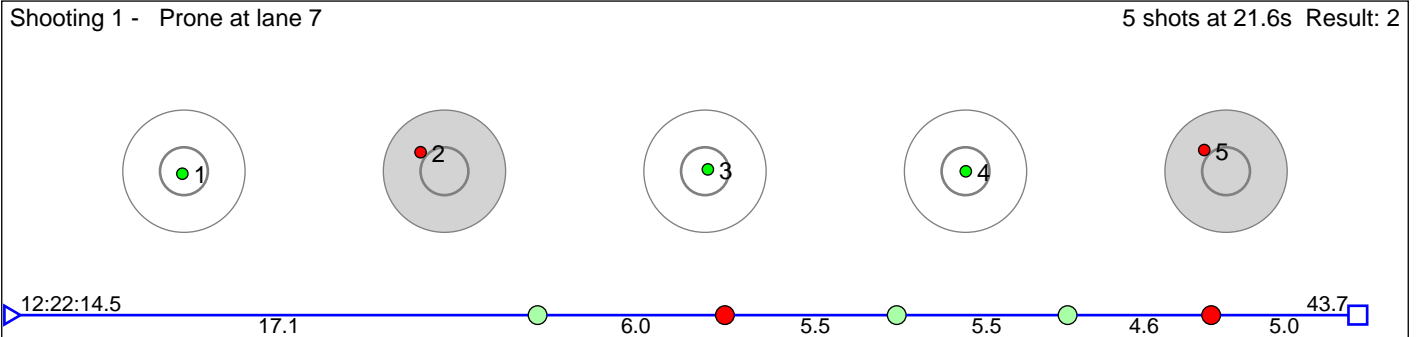

Disclaimer:

These results are unofficial since only the final output from the timing system can provide complete and correct competition results. The graphic plot of each series, presents the location of the shots on each of the five targets. Please observe that the accuracy of the plotting has some limitations due to image resolution and/or printer quality.

38 Lillegraven Torkil Sollien

Voss Skiskytterlag

Result: 17

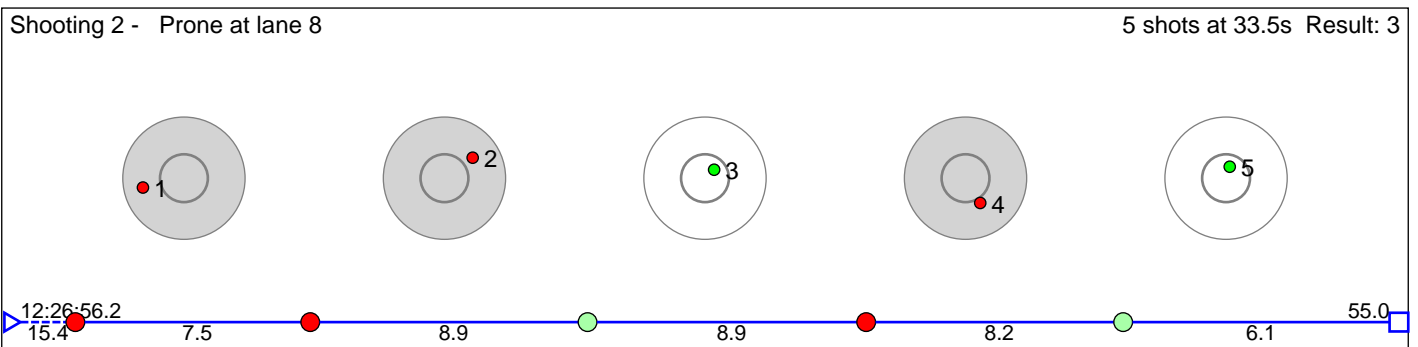
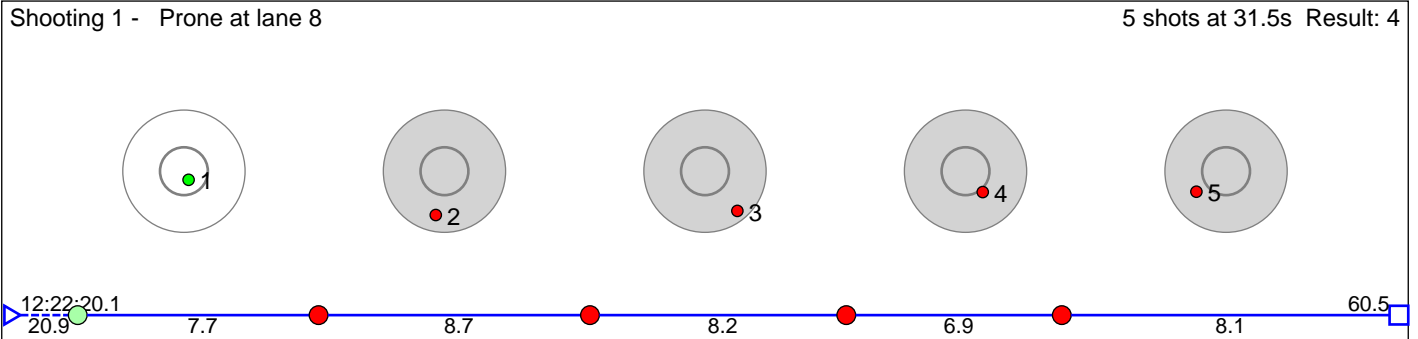

Disclaimer:

These results are unofficial since only the final output from the timing system can provide complete and correct competition results. The graphic plot of each series, presents the location of the shots on each of the five targets. Please observe that the accuracy of the plotting has some limitations due to image resolution and/or printer quality.

39 Utne Peder Sundal

HÅÿlandsdal IL

Result: 13

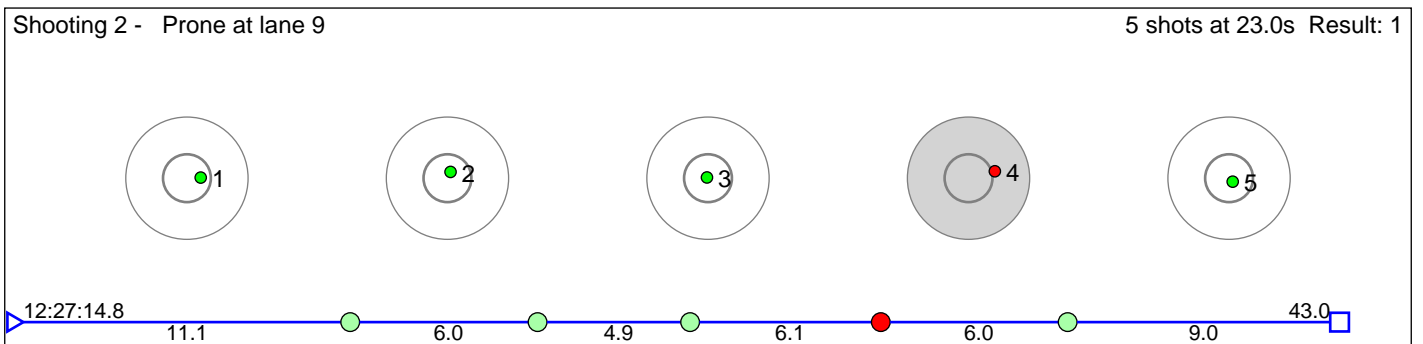
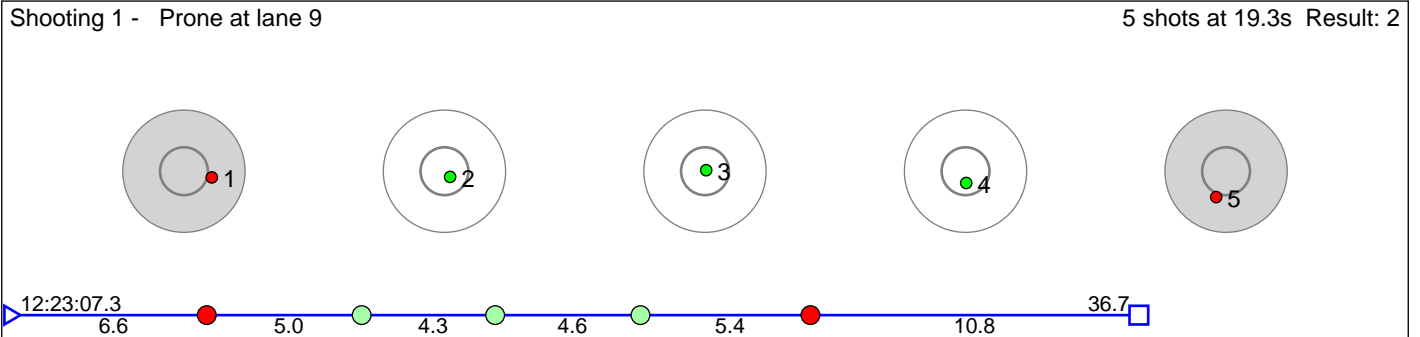

Disclaimer:

These results are unofficial since only the final output from the timing system can provide complete and correct competition results. The graphic plot of each series, presents the location of the shots on each of the five targets. Please observe that the accuracy of the plotting has some limitations due to image resolution and/or printer quality.

40 Jordalen Sindre

Voss Skiskytterlag

Result: 15

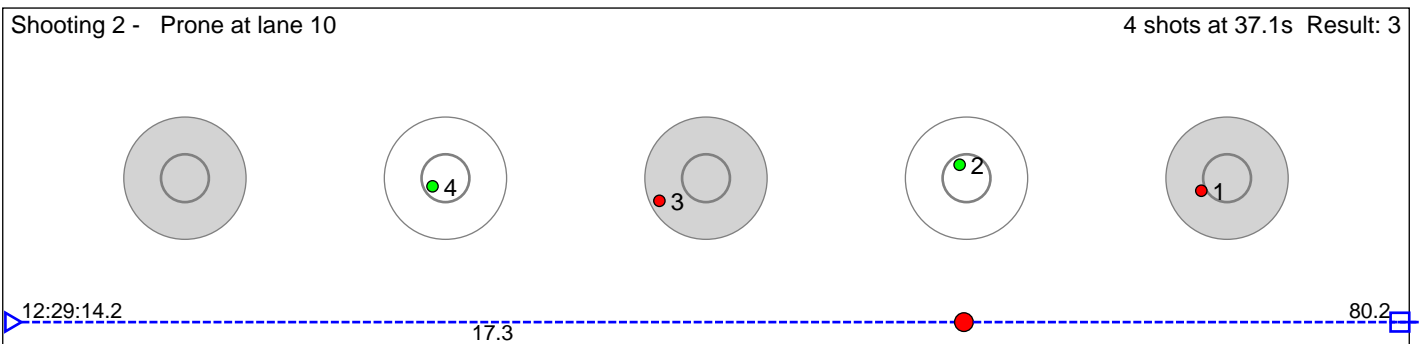
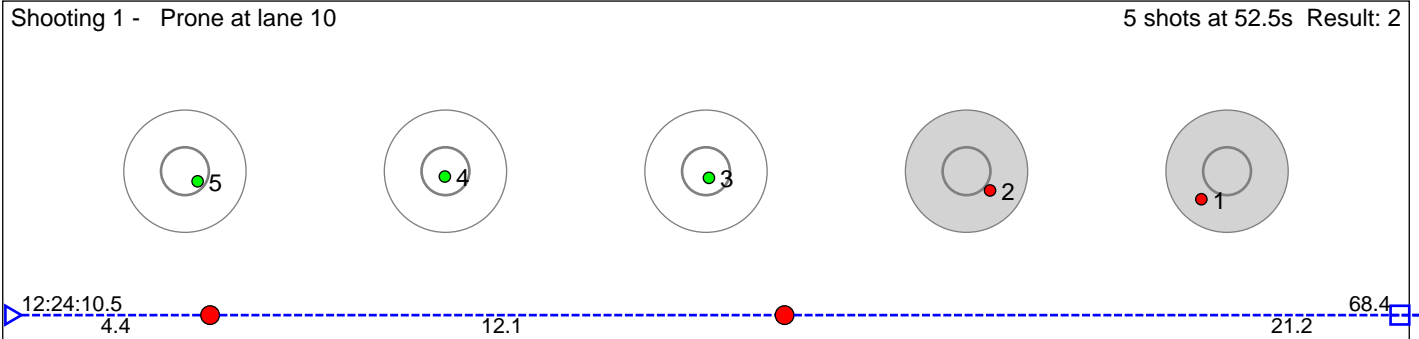

Disclaimer:

These results are unofficial since only the final output from the timing system can provide complete and correct competition results. The graphic plot of each series, presents the location of the shots on each of the five targets. Please observe that the accuracy of the plotting has some limitations due to image resolution and/or printer quality.

41 Lillegraven Sverre Sollien

Voss Skiskytterlag

Result: 15

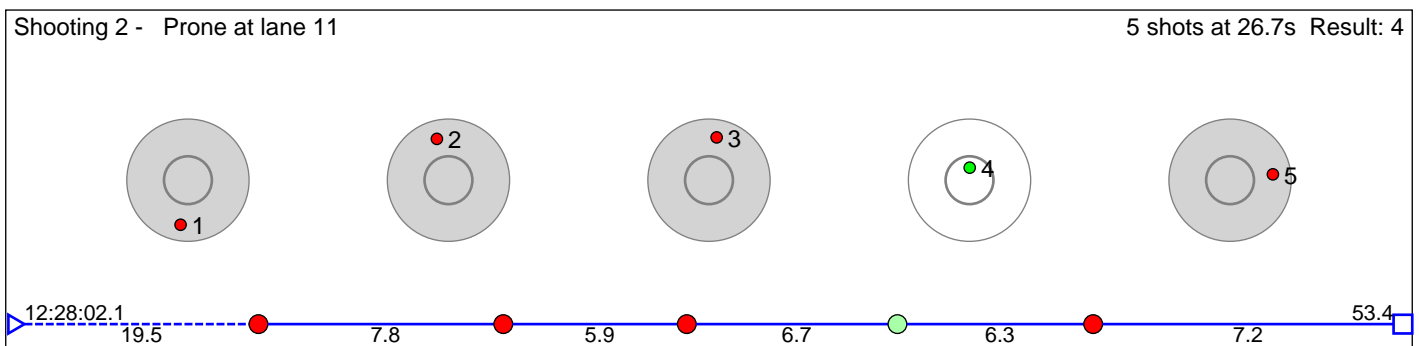
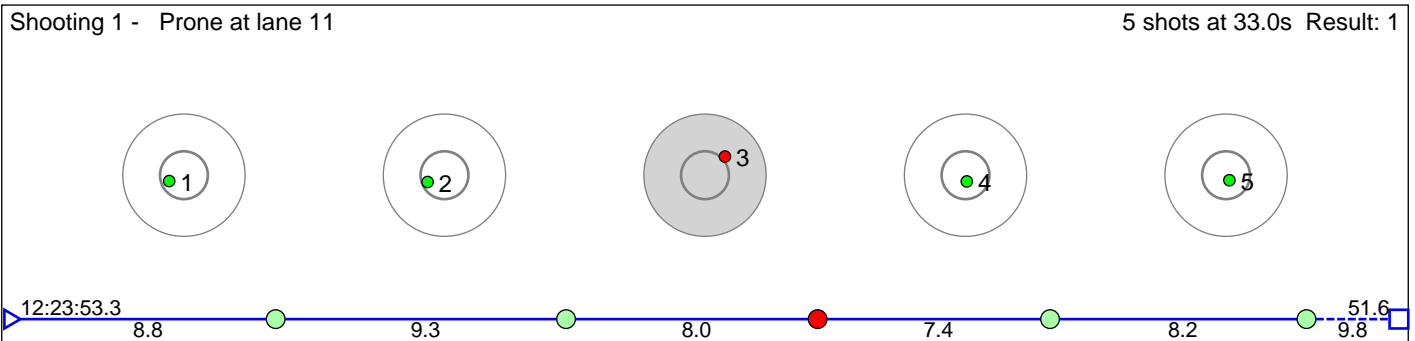

Disclaimer:

These results are unofficial since only the final output from the timing system can provide complete and correct competition results. The graphic plot of each series, presents the location of the shots on each of the five targets. Please observe that the accuracy of the plotting has some limitations due to image resolution and/or printer quality.

42 MÅKestad JÅrgen

Kvam Langrenn- og Skiskyttarklubb

Result: 16

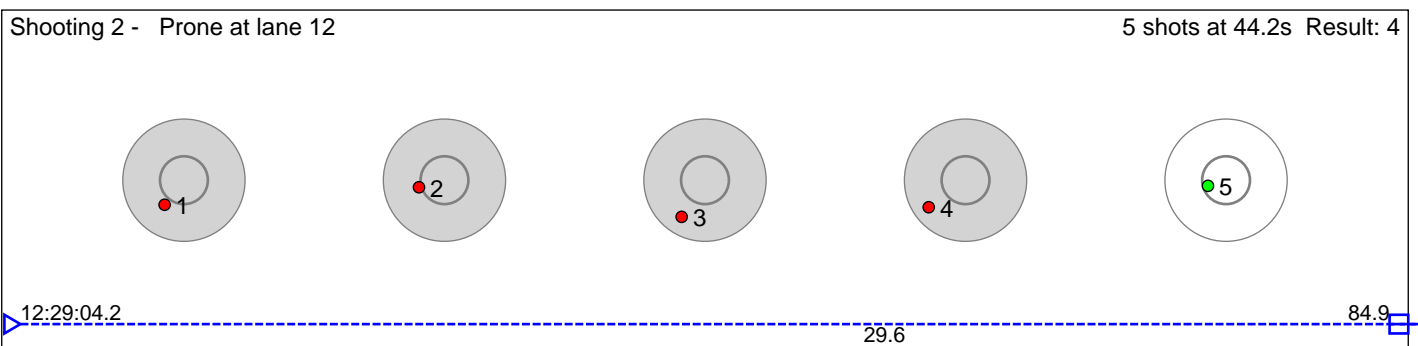
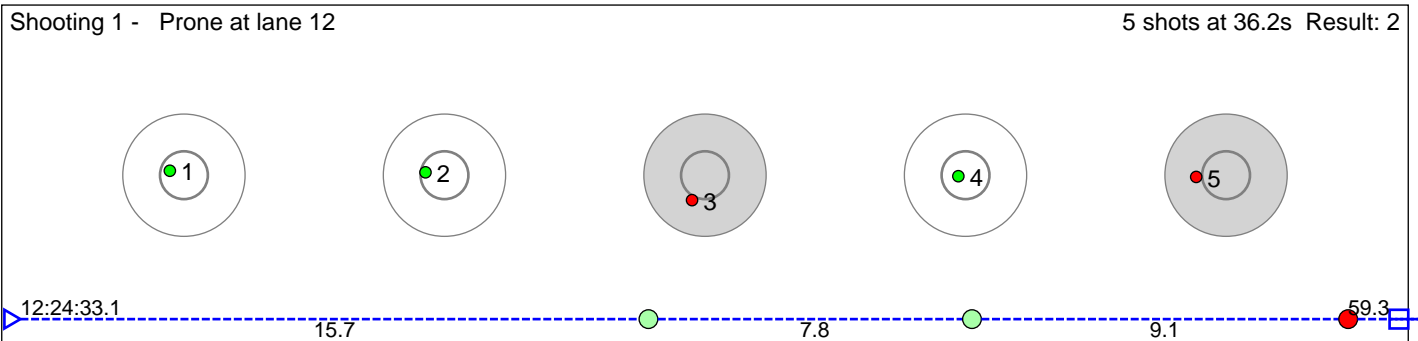

Disclaimer:

These results are unofficial since only the final output from the timing system can provide complete and correct competition results. The graphic plot of each series, presents the location of the shots on each of the five targets. Please observe that the accuracy of the plotting has some limitations due to image resolution and/or printer quality.

45 Mo Synneva Laupsa

Kvam Langrenn- og Skiskyttarklubb

Result: 10

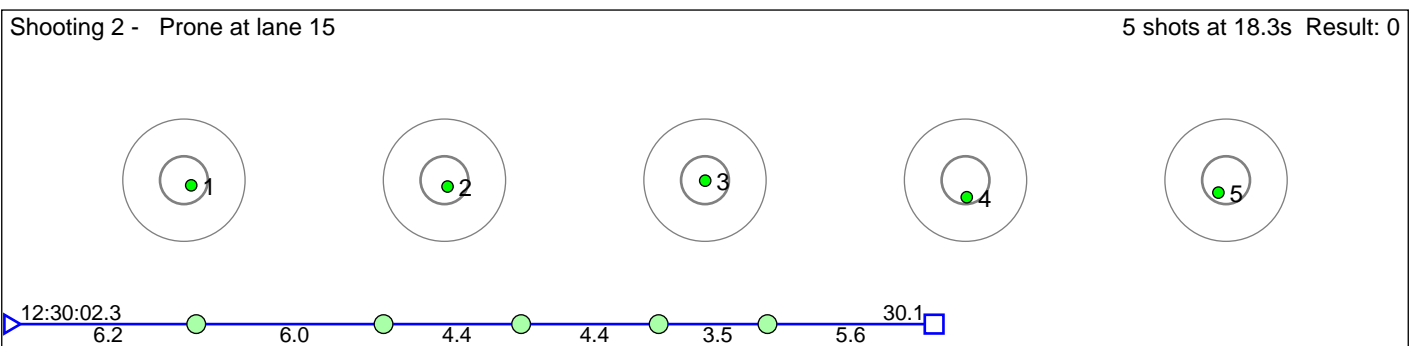
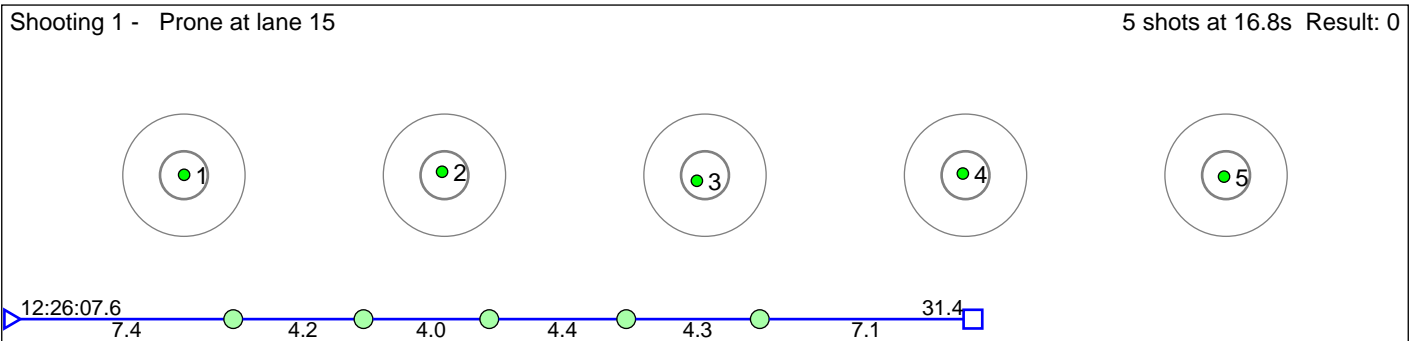

Disclaimer:

These results are unofficial since only the final output from the timing system can provide complete and correct competition results. The graphic plot of each series, presents the location of the shots on each of the five targets. Please observe that the accuracy of the plotting has some limitations due to image resolution and/or printer quality.

46 Ure Eirin

Eldar IL

Result: 16

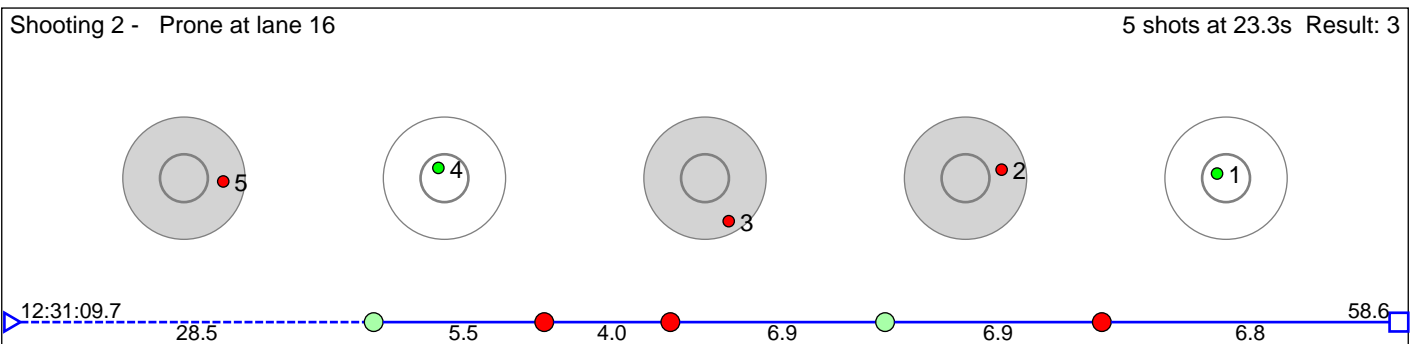
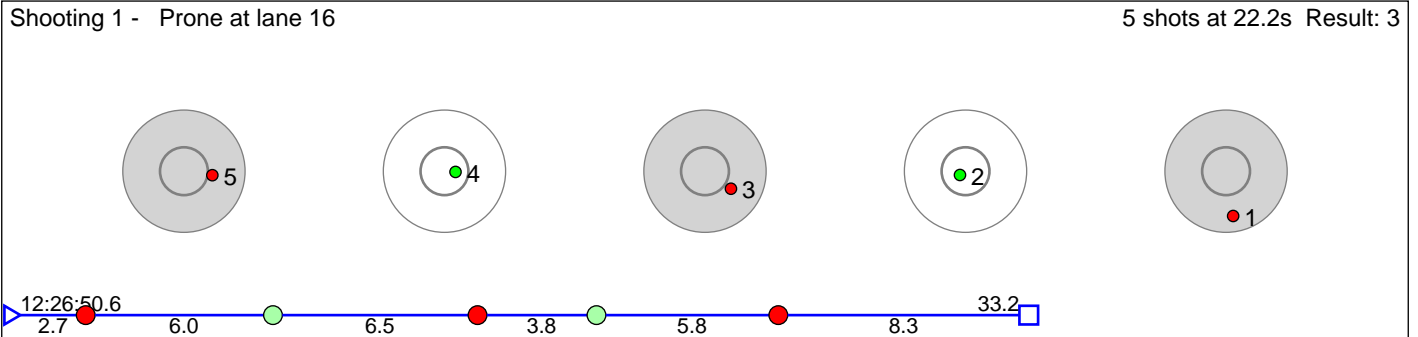

Disclaimer:

These results are unofficial since only the final output from the timing system can provide complete and correct competition results. The graphic plot of each series, presents the location of the shots on each of the five targets. Please observe that the accuracy of the plotting has some limitations due to image resolution and/or printer quality.

47 Kristiansen Maria Istad

Voss Skiskytterlag

Result: 14

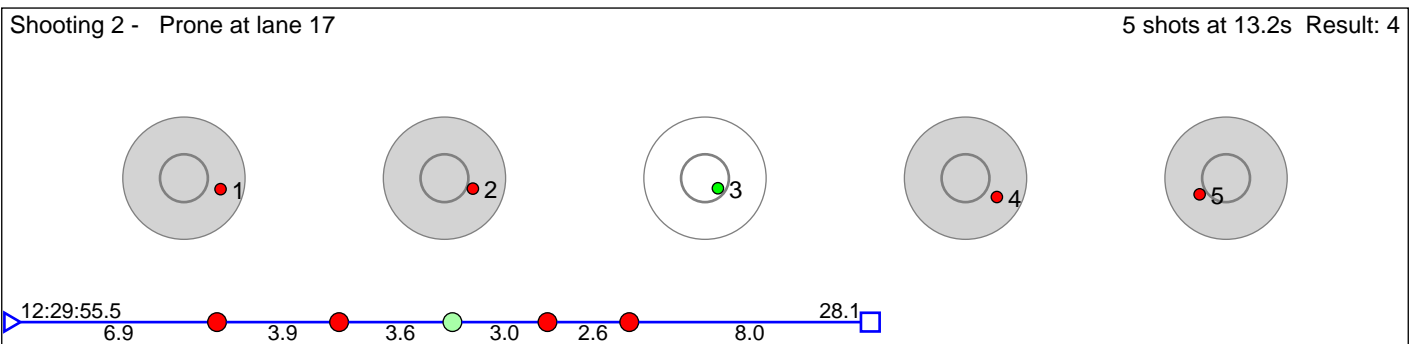
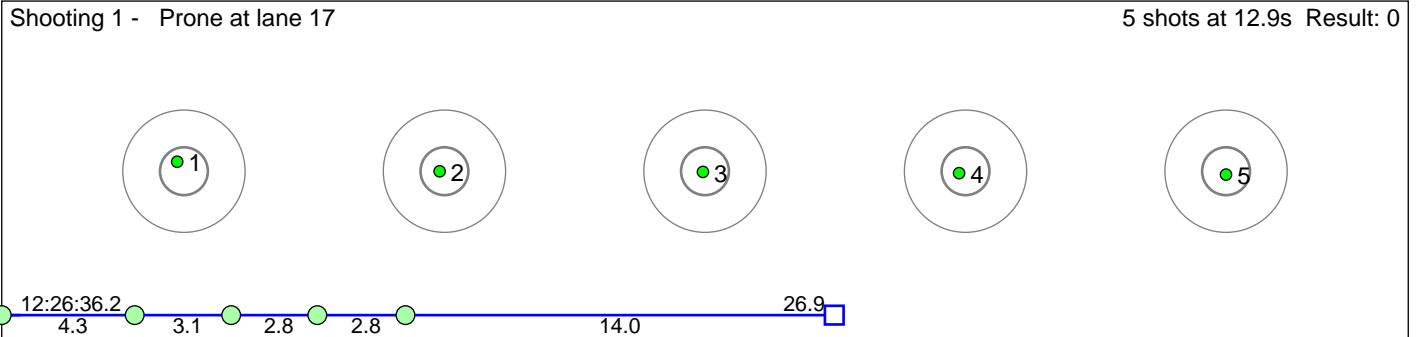

Disclaimer:

These results are unofficial since only the final output from the timing system can provide complete and correct competition results. The graphic plot of each series, presents the location of the shots on each of the five targets. Please observe that the accuracy of the plotting has some limitations due to image resolution and/or printer quality.

49 Fenne Tobias

Voss Skiskytterlag

Result: 10

Shooting 1 - Prone at lane 19 5 shots at 25.6s Result: 0

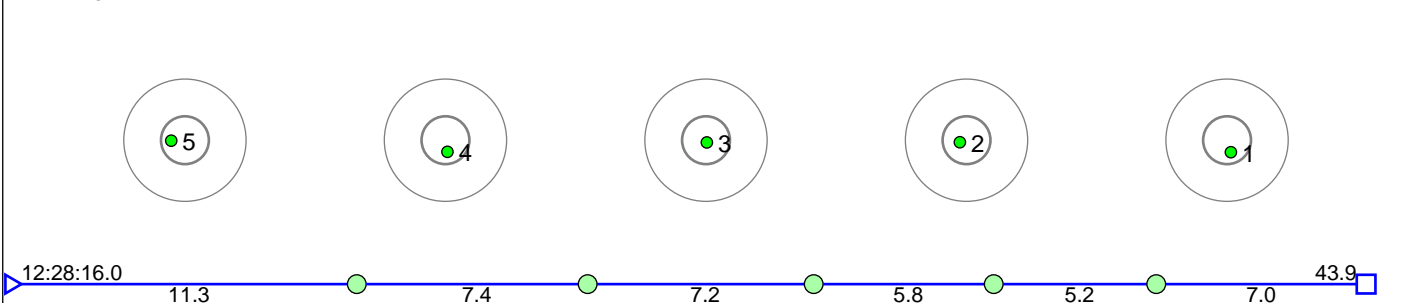

Shooting 2 - Prone at lane 19 5 shots at 34.0s Result: 0

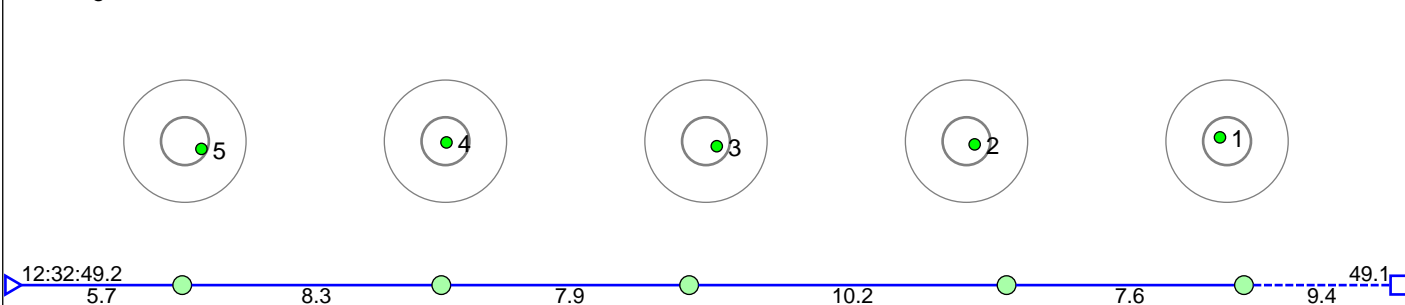

Disclaimer:

These results are unofficial since only the final output from the timing system can provide complete and correct competition results. The graphic plot of each series, presents the location of the shots on each of the five targets. Please observe that the accuracy of the plotting has some limitations due to image resolution and/or printer quality.

50 Gjerme Henrik Haugen

Voss Skiskytterlag

Result: 16

Shooting 1 - Prone at lane 20 5 shots at 17.7s Result: 4

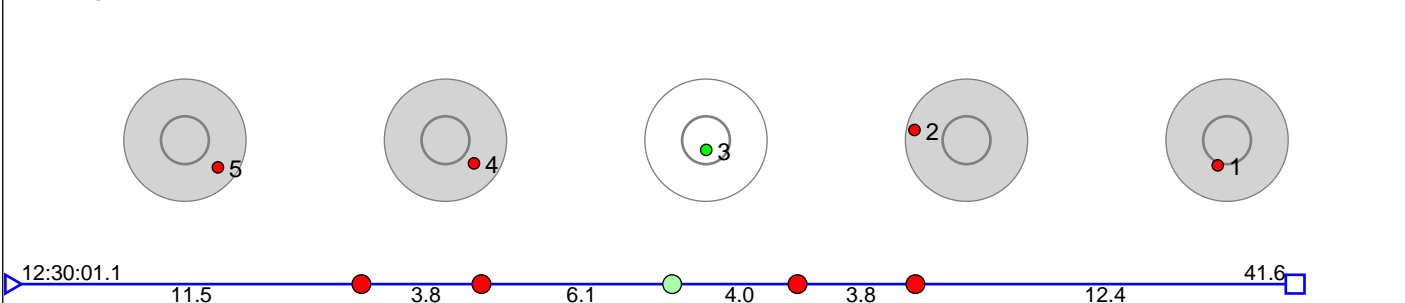

Shooting 2 - Prone at lane 20 5 shots at 22.3s Result: 2

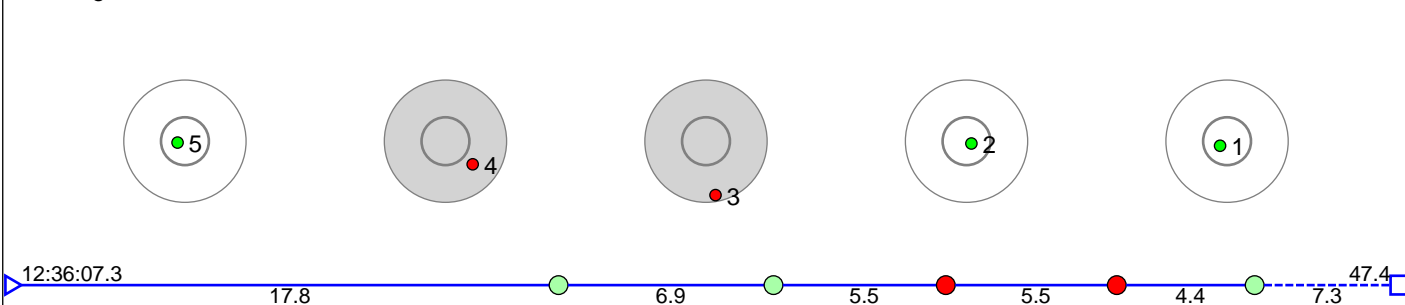

Disclaimer:

These results are unofficial since only the final output from the timing system can provide complete and correct competition results. The graphic plot of each series, presents the location of the shots on each of the five targets. Please observe that the accuracy of the plotting has some limitations due to image resolution and/or printer quality.

51 Folkestad Mathias Caceres

HÅÿlandsdal IL

Result: 12

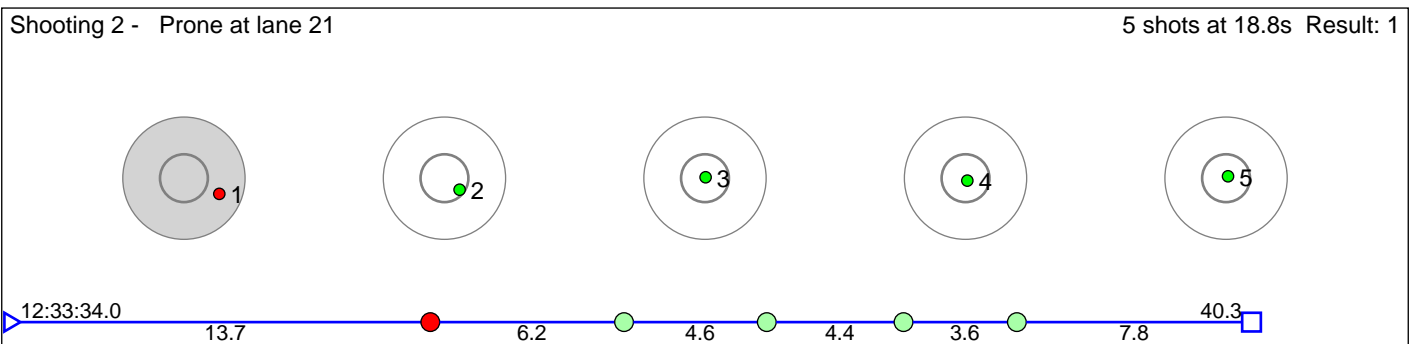
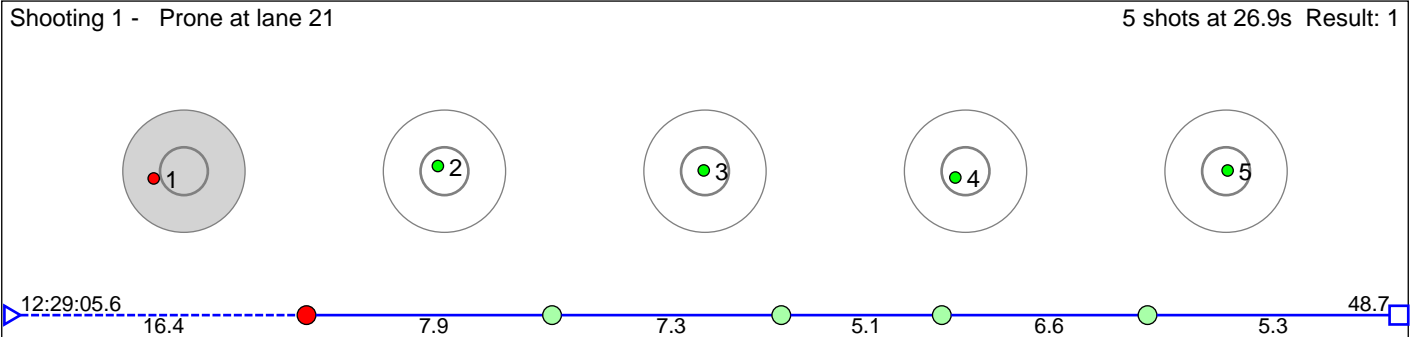

Disclaimer:

These results are unofficial since only the final output from the timing system can provide complete and correct competition results. The graphic plot of each series, presents the location of the shots on each of the five targets. Please observe that the accuracy of the plotting has some limitations due to image resolution and/or printer quality.

52 MÅTTER Balthasar

Kvam Langrenn- og Skiskyttarklubb

Result: 13

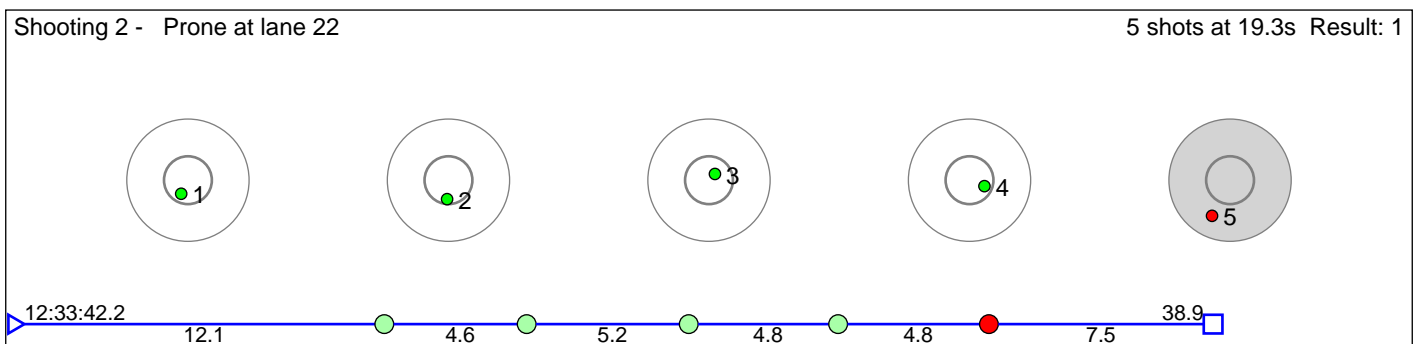
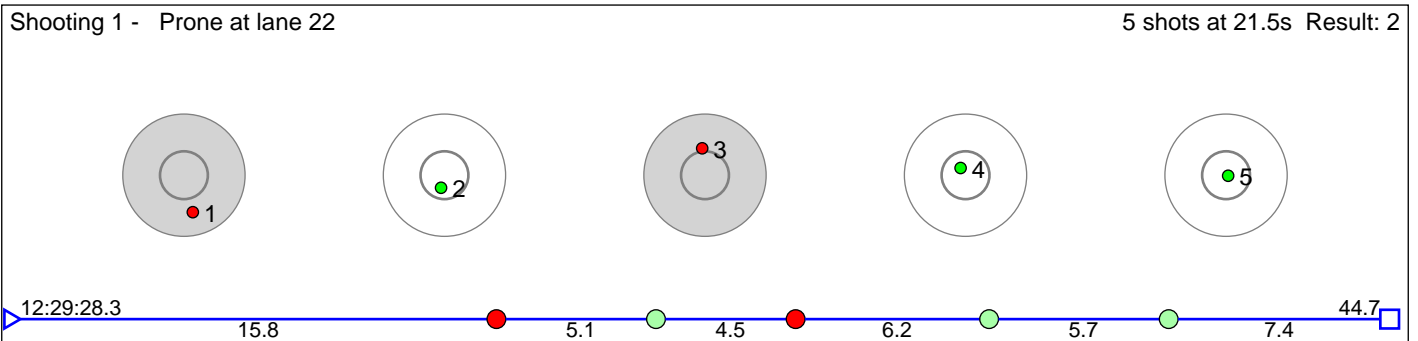

Disclaimer:

These results are unofficial since only the final output from the timing system can provide complete and correct competition results. The graphic plot of each series, presents the location of the shots on each of the five targets. Please observe that the accuracy of the plotting has some limitations due to image resolution and/or printer quality.

57

Result: 13

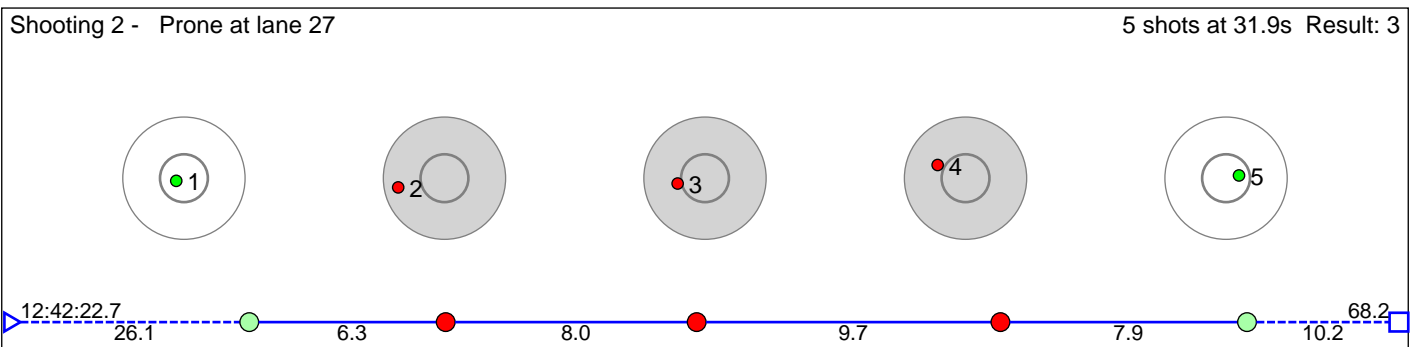
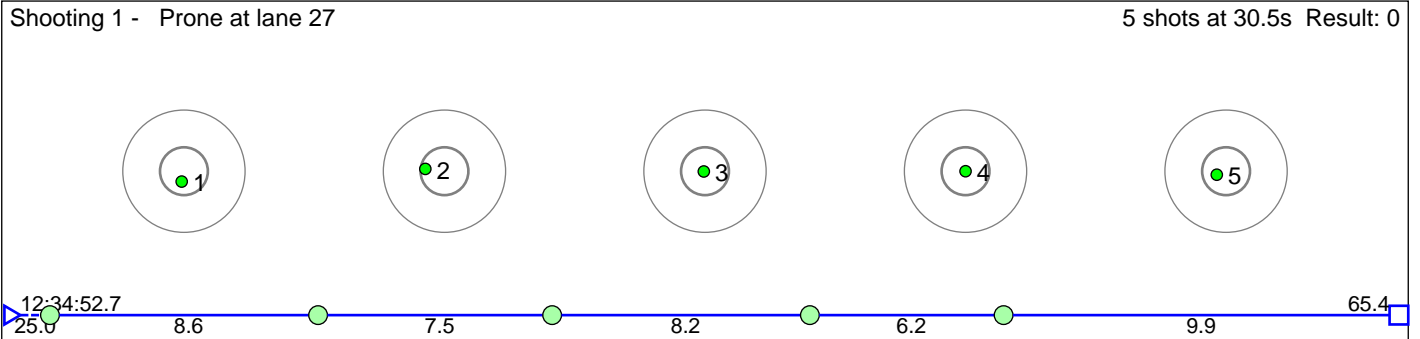

Disclaimer:

These results are unofficial since only the final output from the timing system can provide complete and correct competition results. The graphic plot of each series, presents the location of the shots on each of the five targets. Please observe that the accuracy of the plotting has some limitations due to image resolution and/or printer quality.

58 Utne Cecilie Sundal

HÅÿlandsdal IL

Result: 18

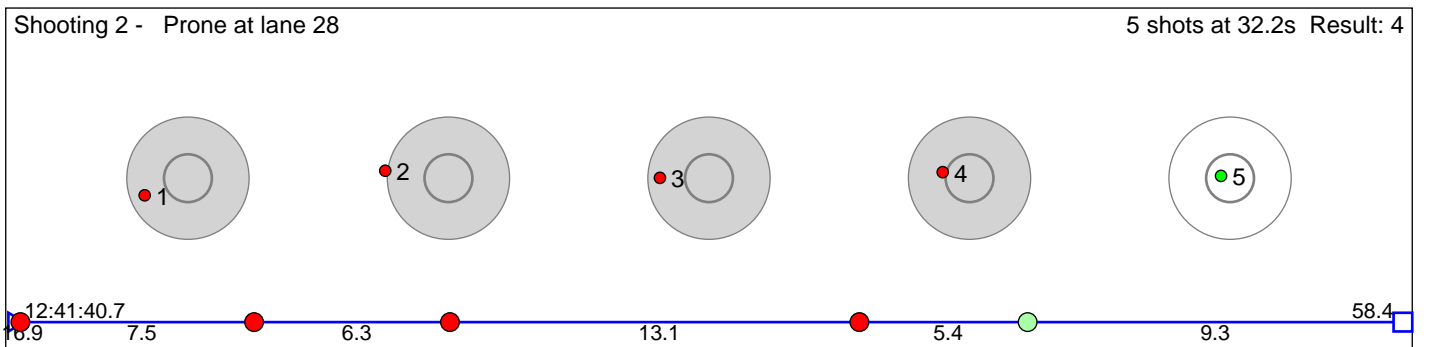
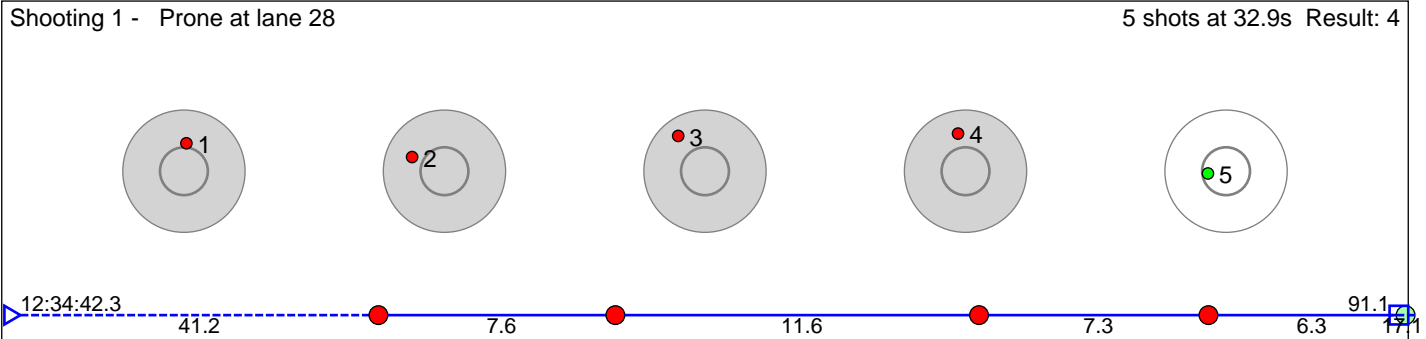

Disclaimer:

These results are unofficial since only the final output from the timing system can provide complete and correct competition results. The graphic plot of each series, presents the location of the shots on each of the five targets. Please observe that the accuracy of the plotting has some limitations due to image resolution and/or printer quality.

60 Gjerald Guro Blikberg

Eldar IL

Result: 17

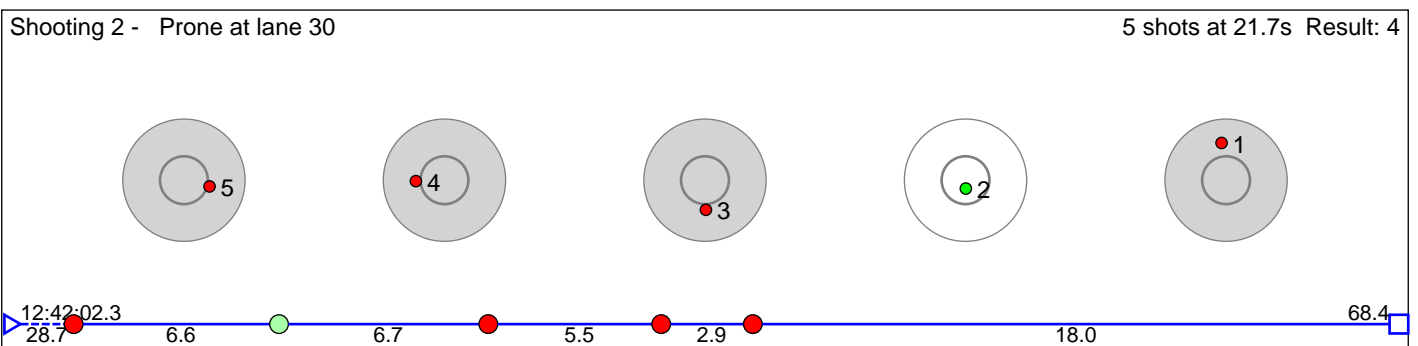
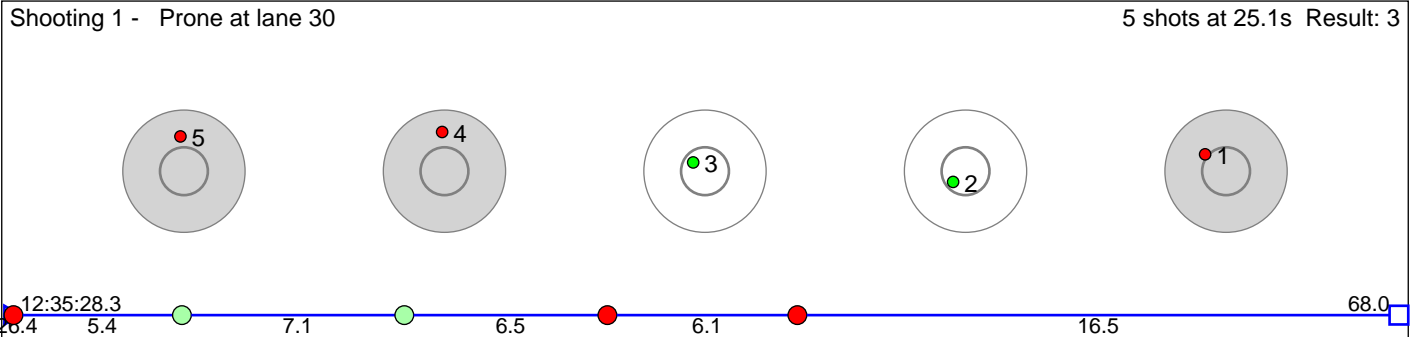

Disclaimer:

These results are unofficial since only the final output from the timing system can provide complete and correct competition results. The graphic plot of each series, presents the location of the shots on each of the five targets. Please observe that the accuracy of the plotting has some limitations due to image resolution and/or printer quality.

62 Abrahamsson Ludwig Gustaf

Odda IL

Result: 15

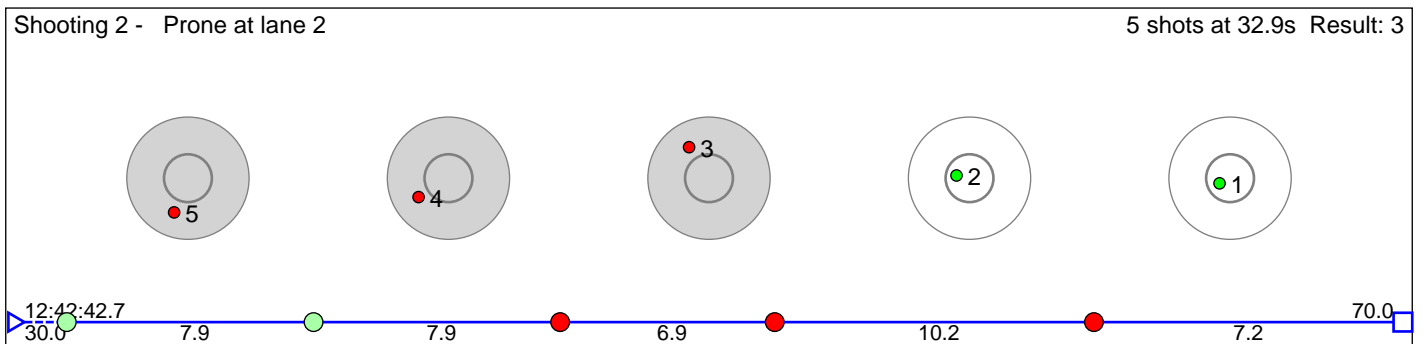
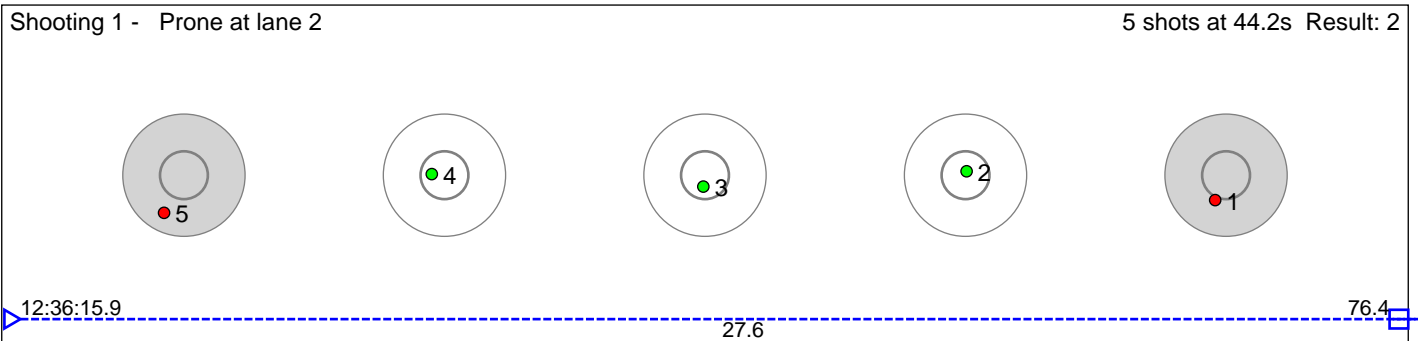

Disclaimer:

These results are unofficial since only the final output from the timing system can provide complete and correct competition results. The graphic plot of each series, presents the location of the shots on each of the five targets. Please observe that the accuracy of the plotting has some limitations due to image resolution and/or printer quality.

63 LÃyning Sigurd Oma

Odda IL

Result: 15

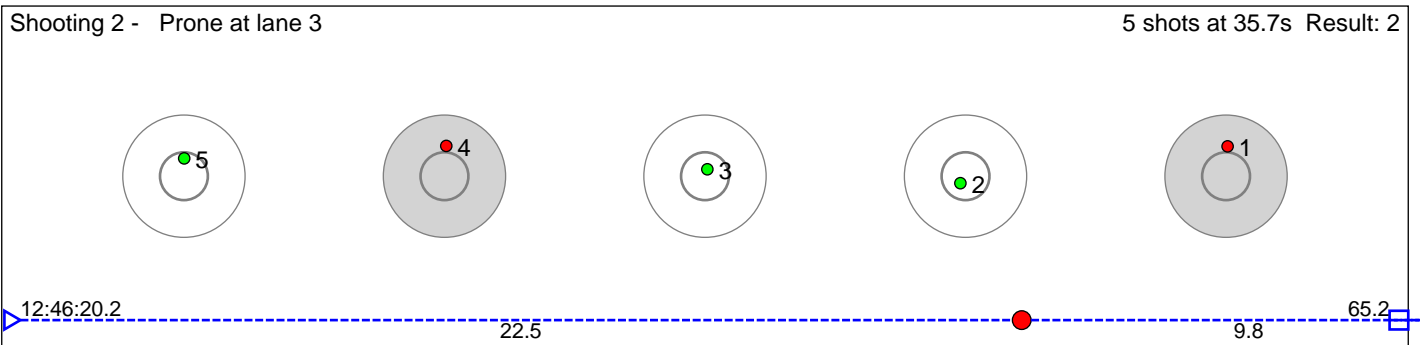
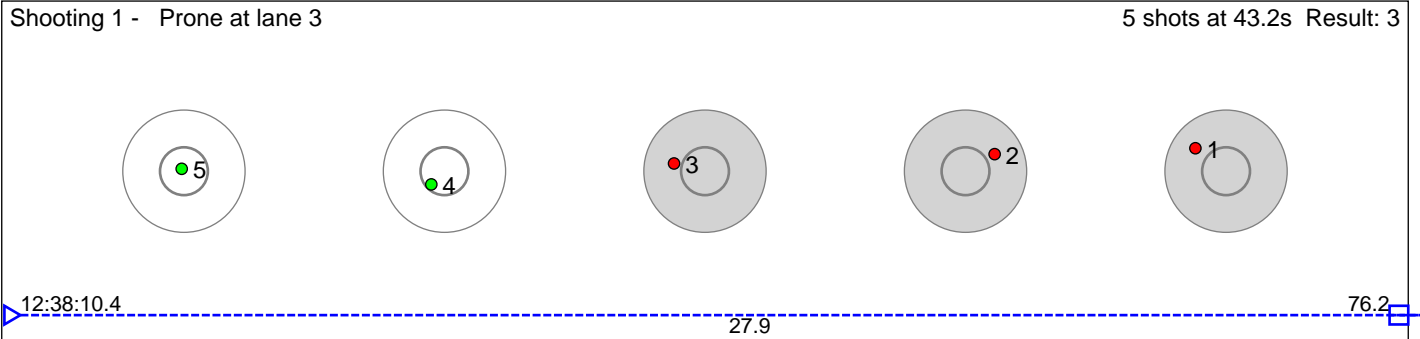

Disclaimer:

These results are unofficial since only the final output from the timing system can provide complete and correct competition results. The graphic plot of each series, presents the location of the shots on each of the five targets. Please observe that the accuracy of the plotting has some limitations due to image resolution and/or printer quality.

64 Abrahamsson Edwin Gustaf

Odda IL

Result: 18

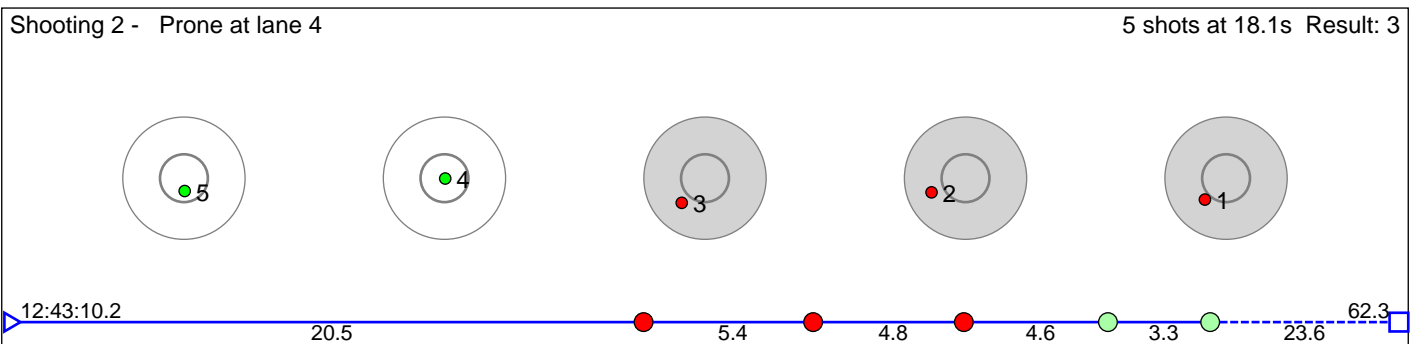
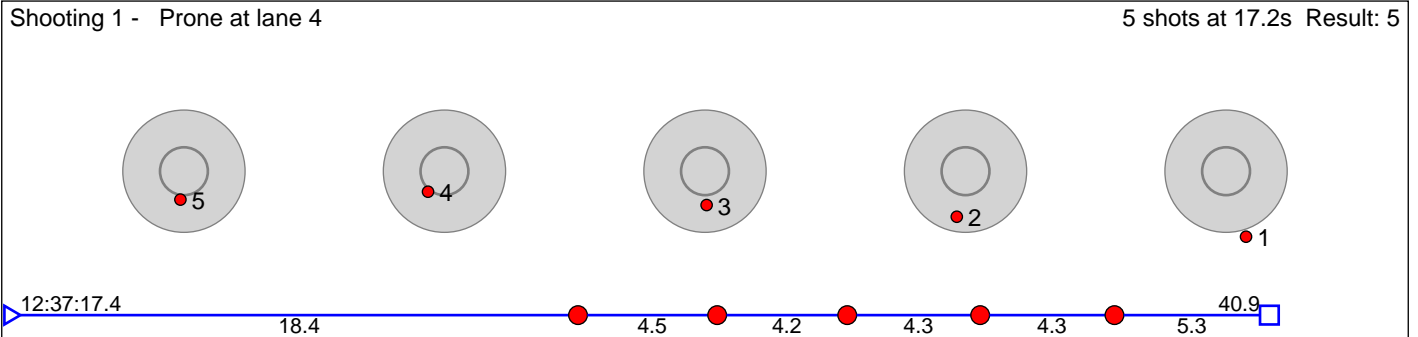

Disclaimer:

These results are unofficial since only the final output from the timing system can provide complete and correct competition results. The graphic plot of each series, presents the location of the shots on each of the five targets. Please observe that the accuracy of the plotting has some limitations due to image resolution and/or printer quality.

65 RÅ_d Nicolai Å svang

HÅ¶landsdal IL

Result: 13

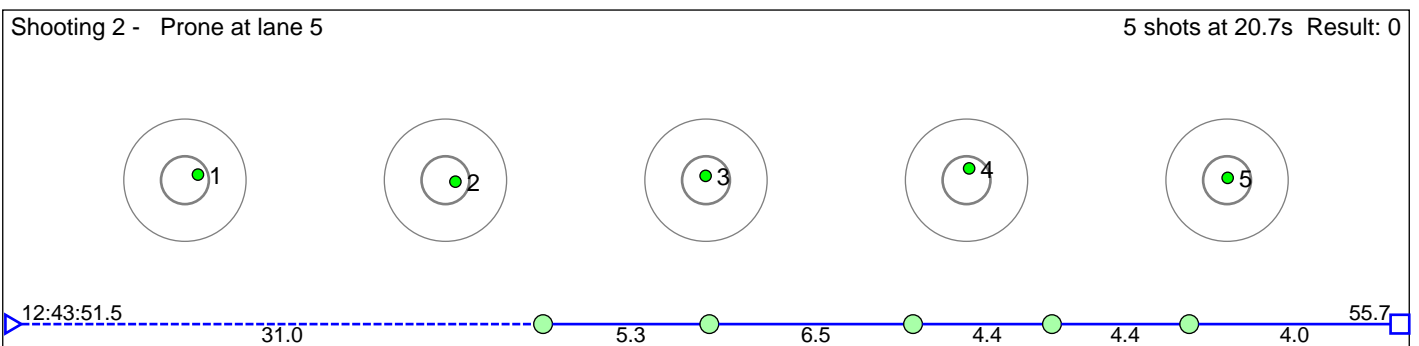
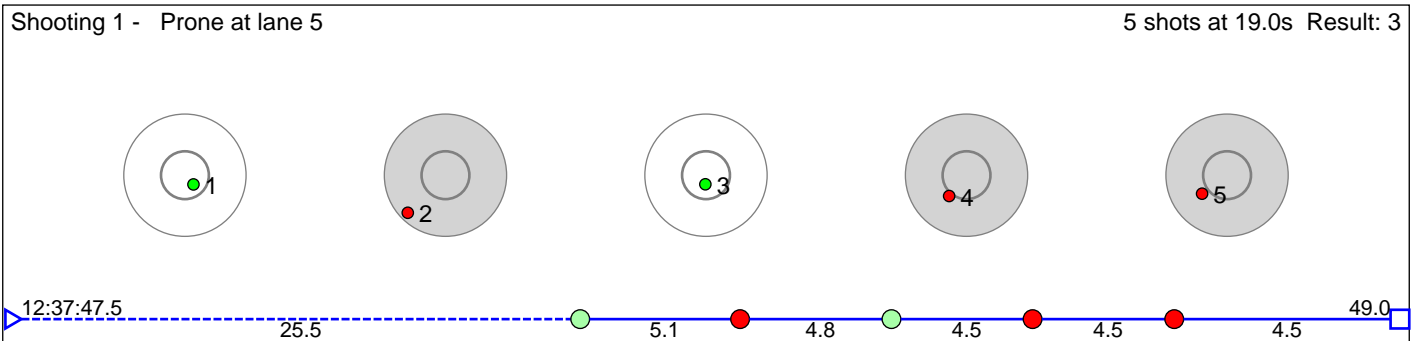

Disclaimer:

These results are unofficial since only the final output from the timing system can provide complete and correct competition results. The graphic plot of each series, presents the location of the shots on each of the five targets. Please observe that the accuracy of the plotting has some limitations due to image resolution and/or printer quality.

67 Tveite Ingrid Knapstad

Eldar IL

Result: 15

Shooting 1 - Prone at lane 7 5 shots at 29.6s Result: 2

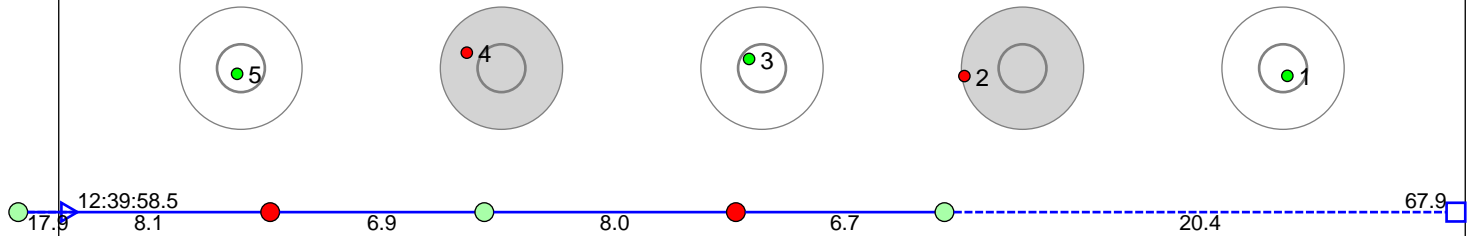

Shooting 2 - Prone at lane 7 5 shots at 33.5s Result: 3

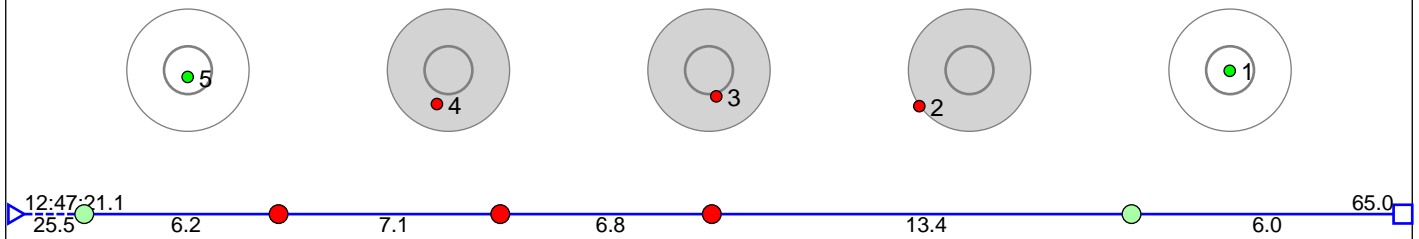

Disclaimer:

These results are unofficial since only the final output from the timing system can provide complete and correct competition results. The graphic plot of each series, presents the location of the shots on each of the five targets. Please observe that the accuracy of the plotting has some limitations due to image resolution and/or printer quality.

68 Skagen Celine Fosse

Vik IL

Result: 15

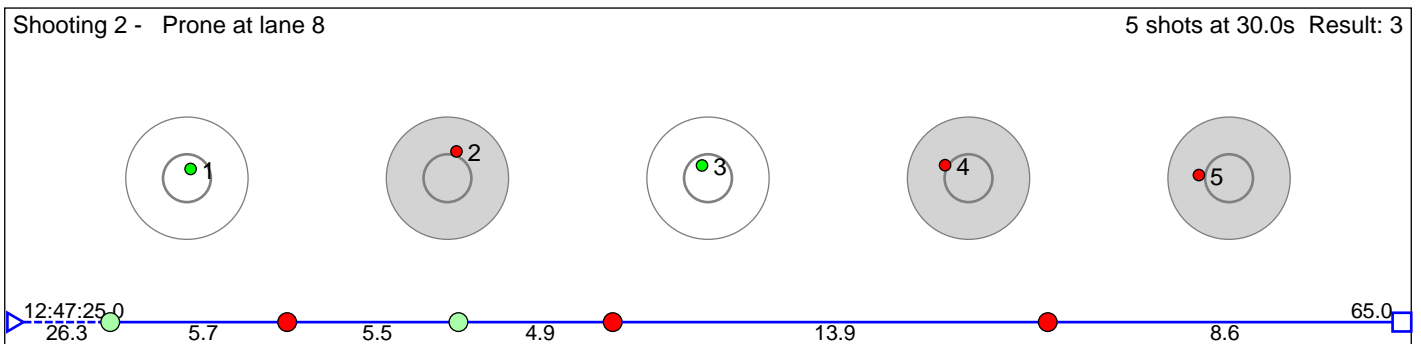
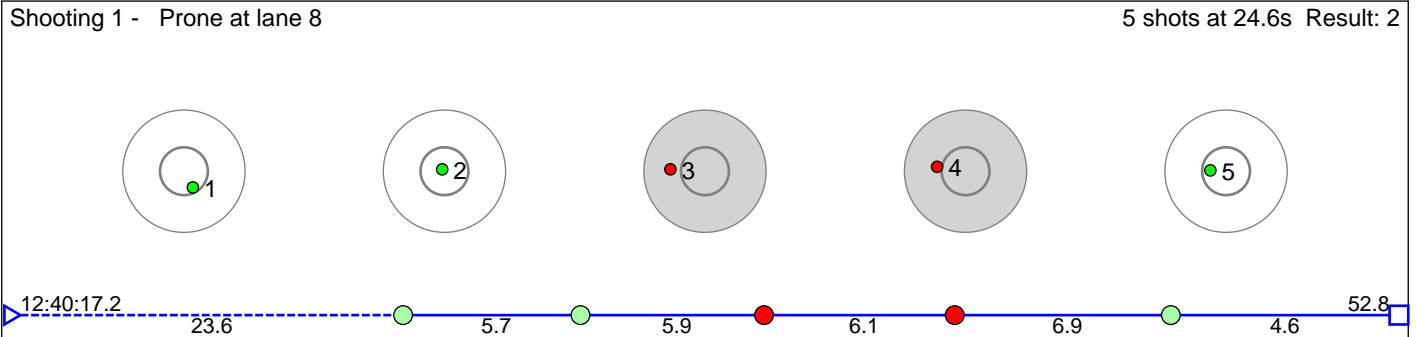

Disclaimer:

These results are unofficial since only the final output from the timing system can provide complete and correct competition results. The graphic plot of each series, presents the location of the shots on each of the five targets. Please observe that the accuracy of the plotting has some limitations due to image resolution and/or printer quality.

70 MÅLLer Philomene

Kvam Langrenn- og Skiskyttarklubb

Result: 19

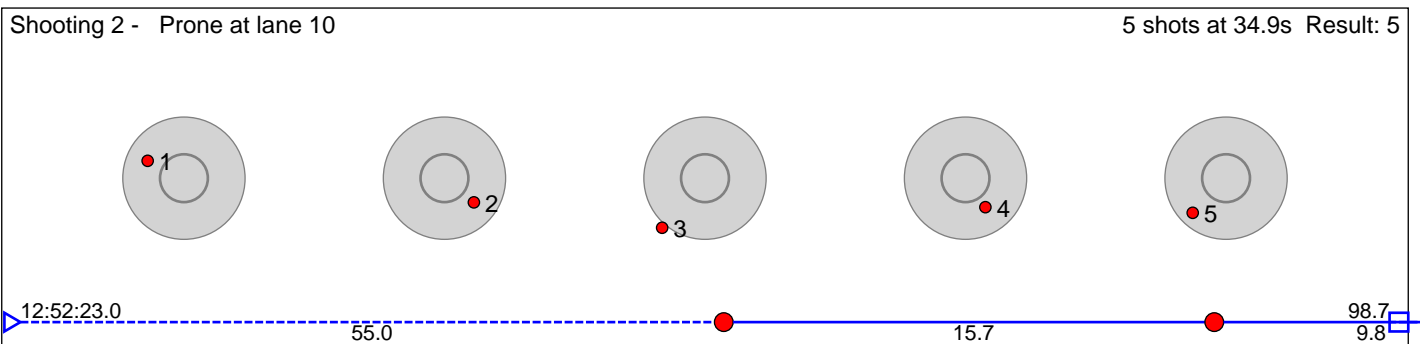
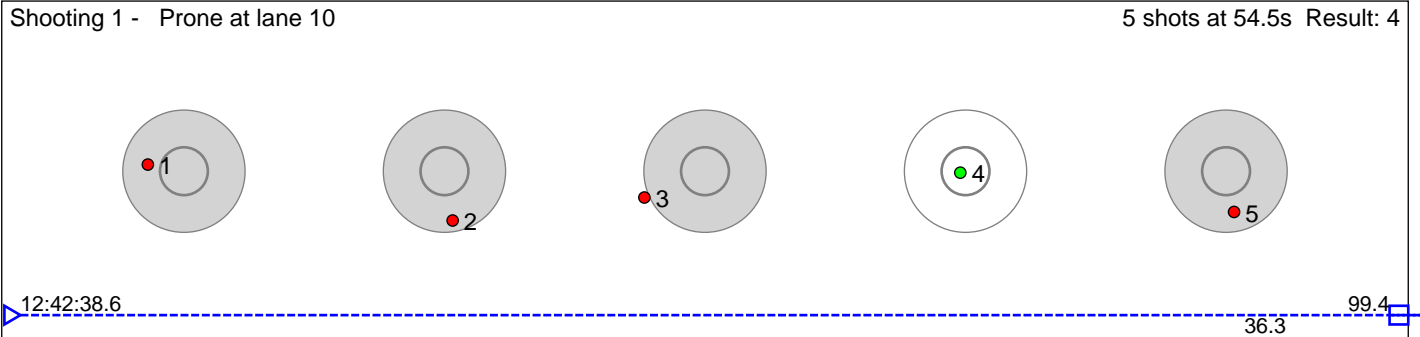

Disclaimer:

These results are unofficial since only the final output from the timing system can provide complete and correct competition results. The graphic plot of each series, presents the location of the shots on each of the five targets. Please observe that the accuracy of the plotting has some limitations due to image resolution and/or printer quality.

71

Result: 14

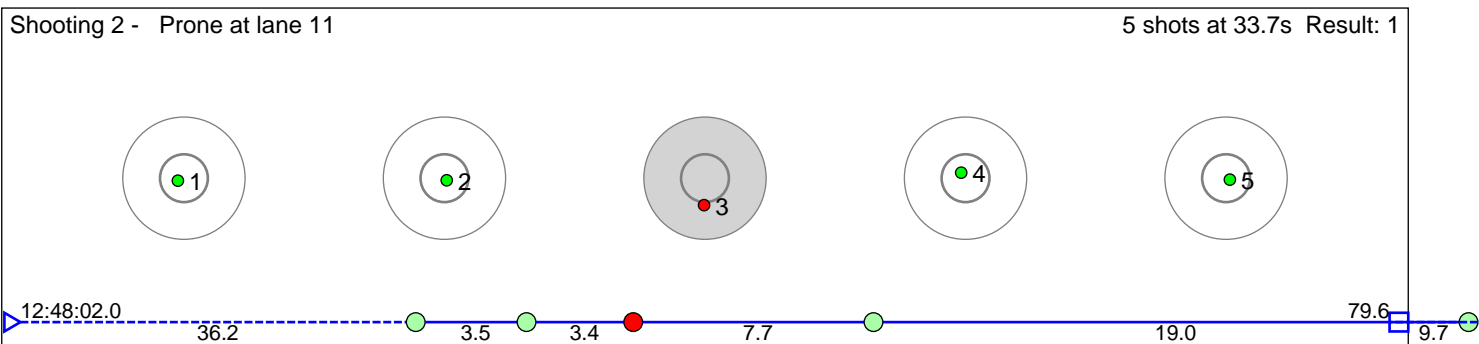
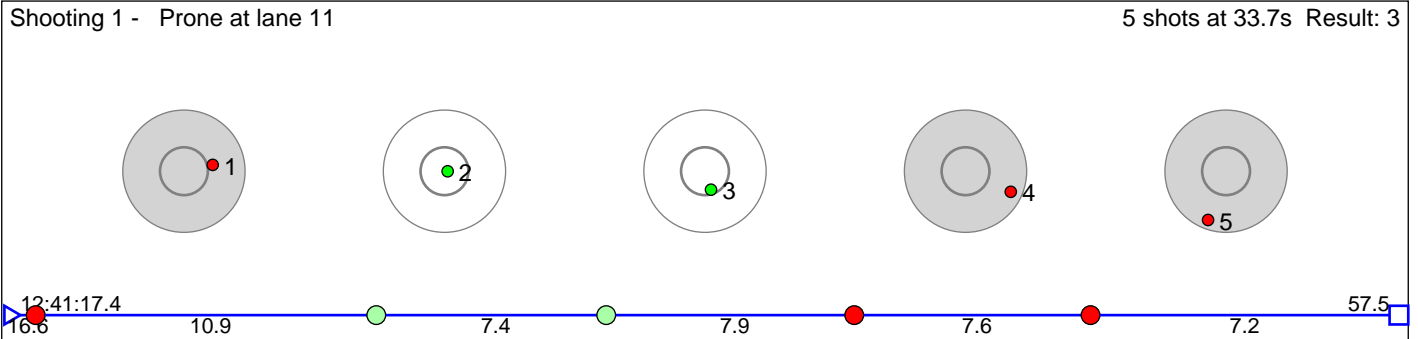

Disclaimer:

These results are unofficial since only the final output from the timing system can provide complete and correct competition results. The graphic plot of each series, presents the location of the shots on each of the five targets. Please observe that the accuracy of the plotting has some limitations due to image resolution and/or printer quality.

72 Femsteinevik Gitle

HÅÿlandsdal IL

Result: 14

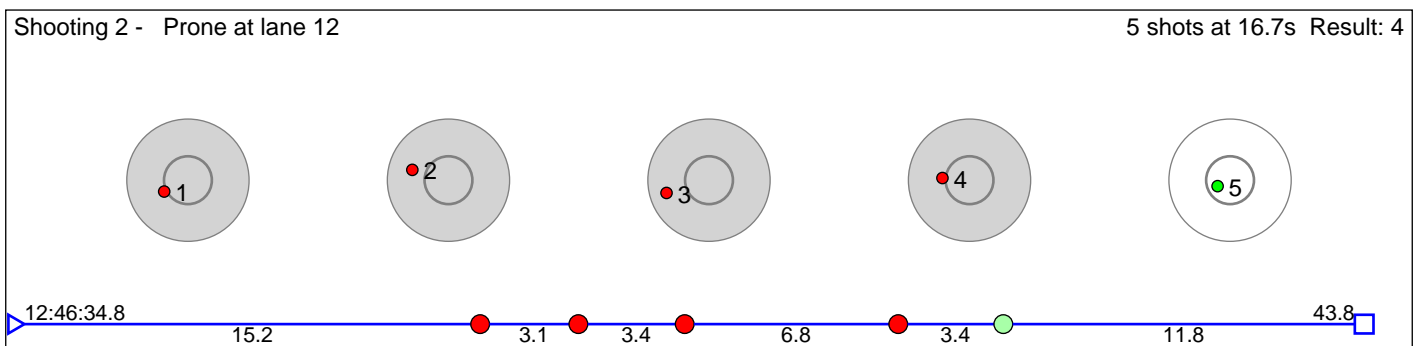
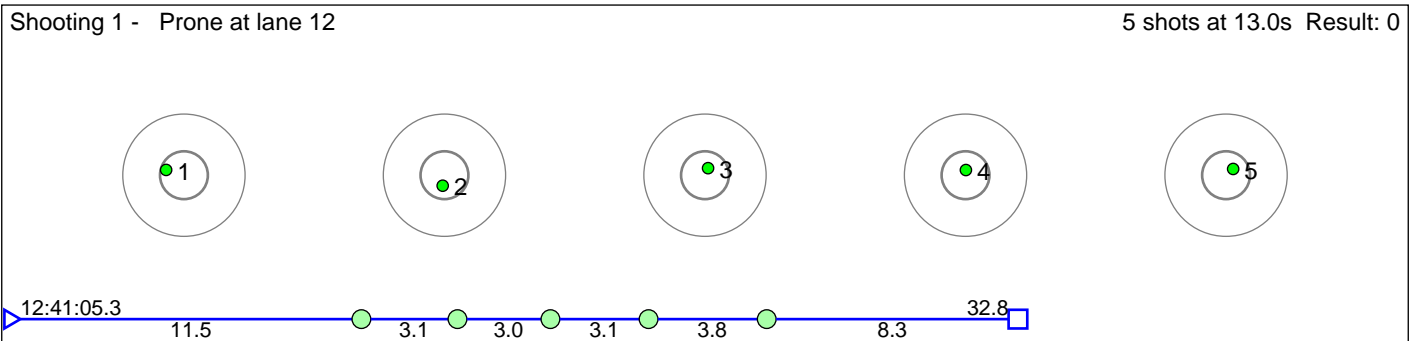

Disclaimer:

These results are unofficial since only the final output from the timing system can provide complete and correct competition results. The graphic plot of each series, presents the location of the shots on each of the five targets. Please observe that the accuracy of the plotting has some limitations due to image resolution and/or printer quality.

73 Hemre Oskar Stoknes

Voss Skiskytterlag

Result: 17

Shooting 1 - Prone at lane 13 5 shots at 21.4s Result: 3

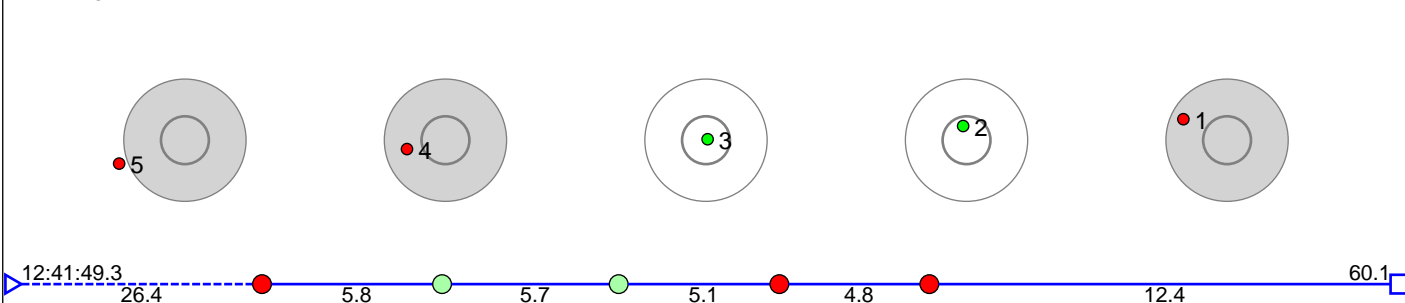

Shooting 2 - Prone at lane 13 5 shots at 23.5s Result: 4

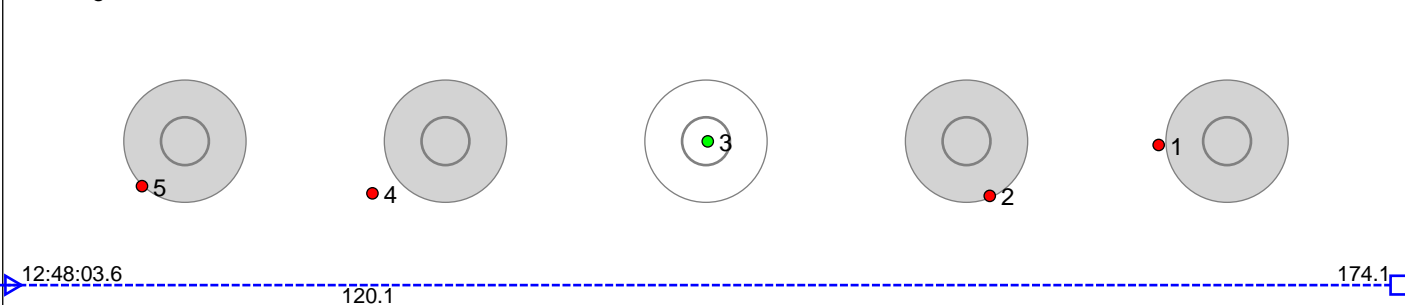

Disclaimer:

These results are unofficial since only the final output from the timing system can provide complete and correct competition results. The graphic plot of each series, presents the location of the shots on each of the five targets. Please observe that the accuracy of the plotting has some limitations due to image resolution and/or printer quality.

75 Halvorsen Ingeborg Henanger

HÅÏlandsdal IL

Result: 11

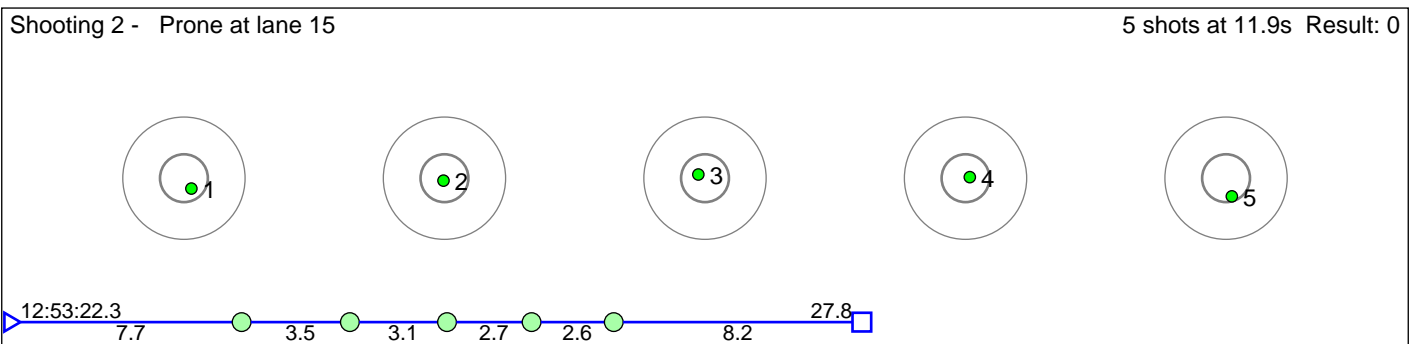
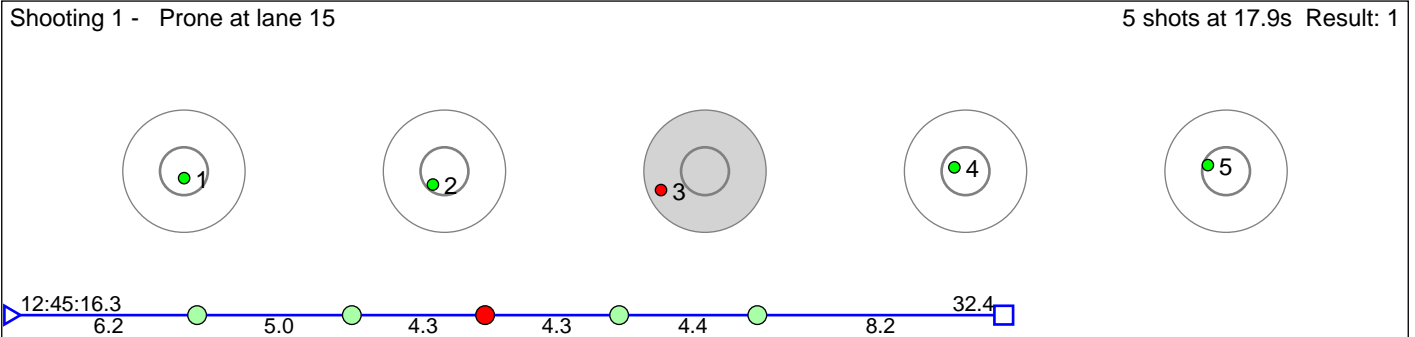

Disclaimer:

These results are unofficial since only the final output from the timing system can provide complete and correct competition results. The graphic plot of each series, presents the location of the shots on each of the five targets. Please observe that the accuracy of the plotting has some limitations due to image resolution and/or printer quality.

76 Garverhaugen Symra Emilia

Fana IL

Result: 13

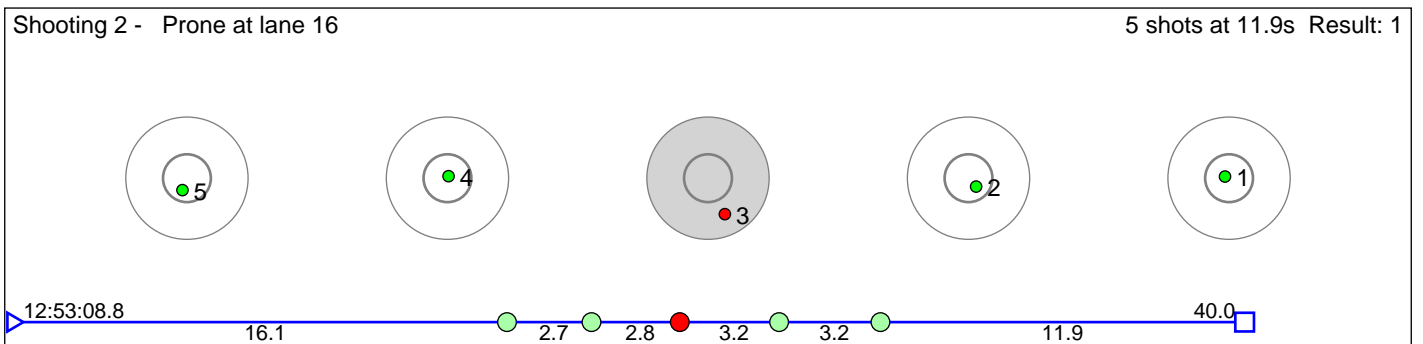
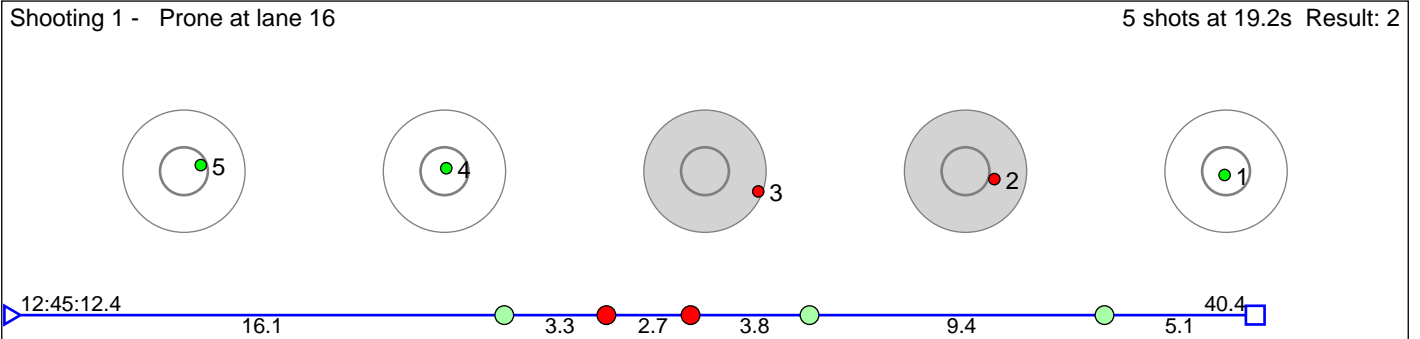

Disclaimer:

These results are unofficial since only the final output from the timing system can provide complete and correct competition results. The graphic plot of each series, presents the location of the shots on each of the five targets. Please observe that the accuracy of the plotting has some limitations due to image resolution and/or printer quality.

78 Kvelvane Abel Tronerud

Voss Skiskytterlag

Result: 12

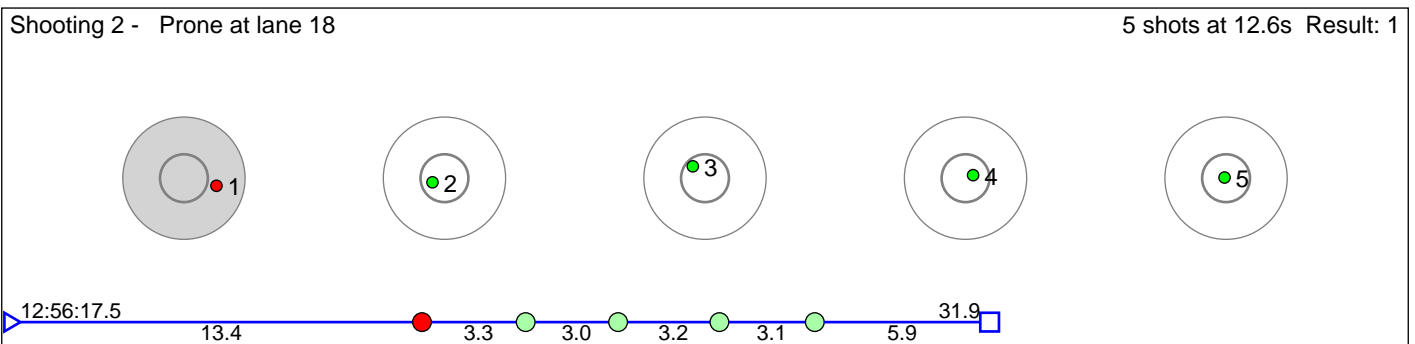
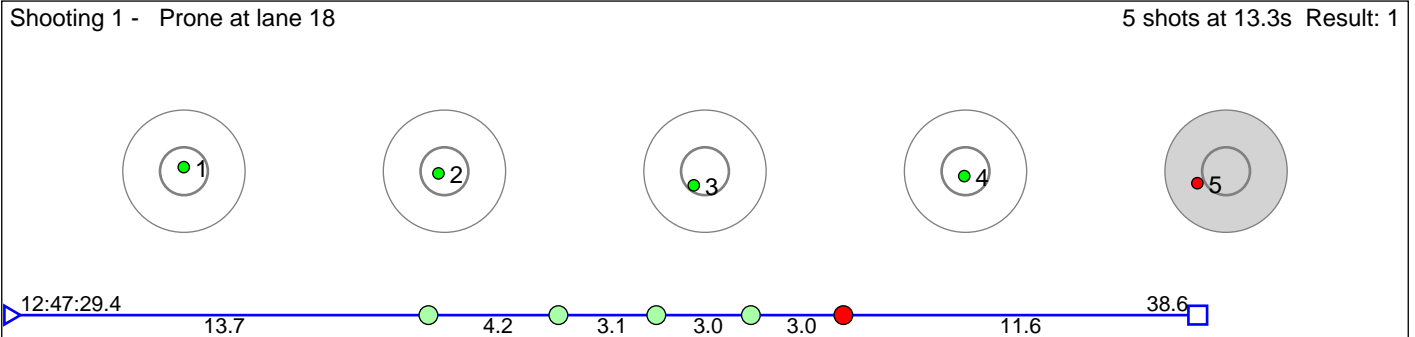

Disclaimer:

These results are unofficial since only the final output from the timing system can provide complete and correct competition results. The graphic plot of each series, presents the location of the shots on each of the five targets. Please observe that the accuracy of the plotting has some limitations due to image resolution and/or printer quality.

79 Ulvund Eirik

Eldar IL

Result: 13

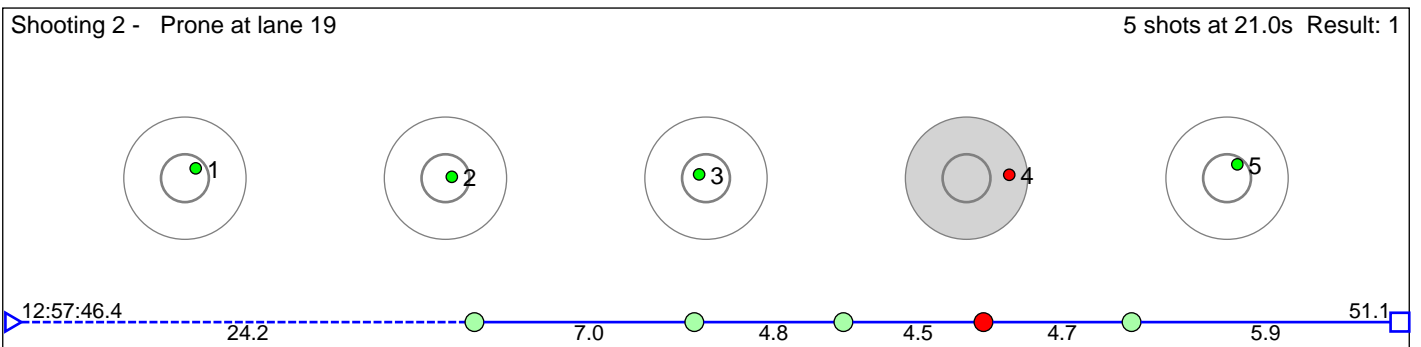
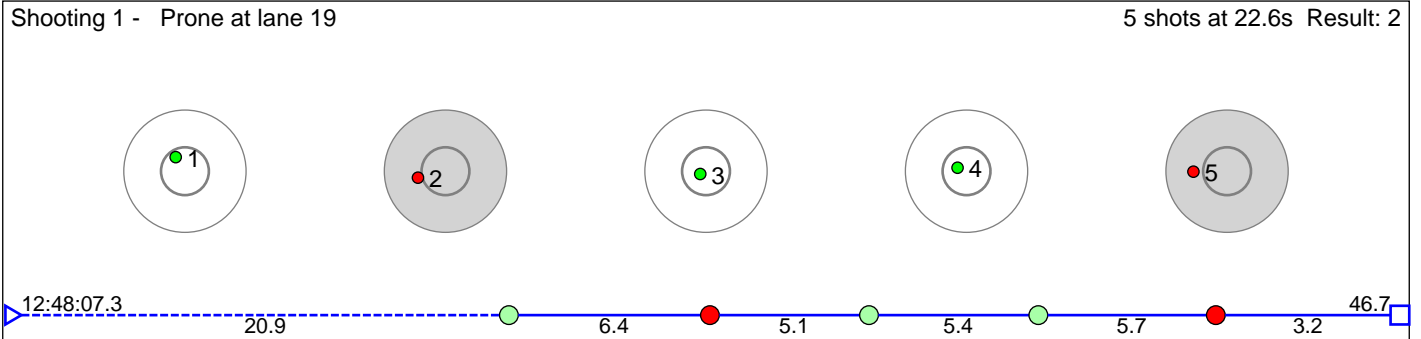

Disclaimer:

These results are unofficial since only the final output from the timing system can provide complete and correct competition results. The graphic plot of each series, presents the location of the shots on each of the five targets. Please observe that the accuracy of the plotting has some limitations due to image resolution and/or printer quality.

80 Gjerald Emil Blikberg

Eldar IL

Result: 16

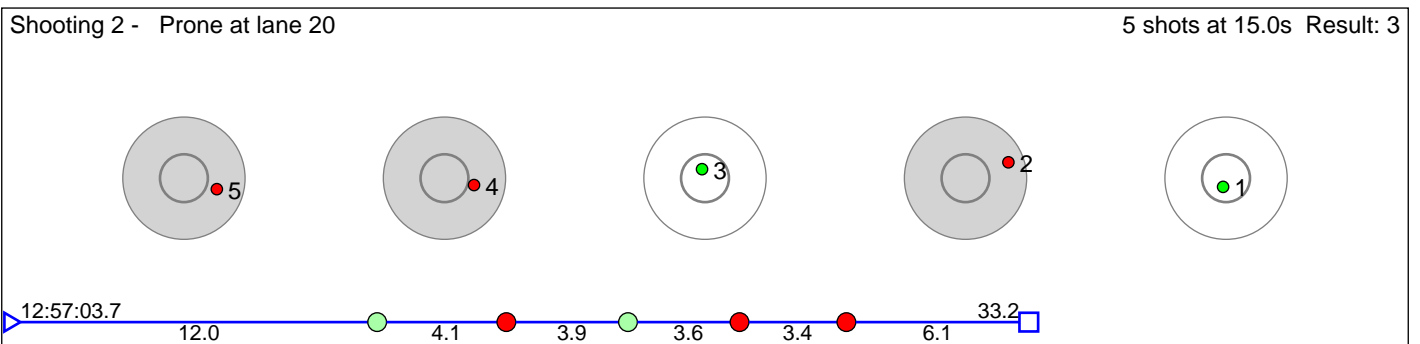
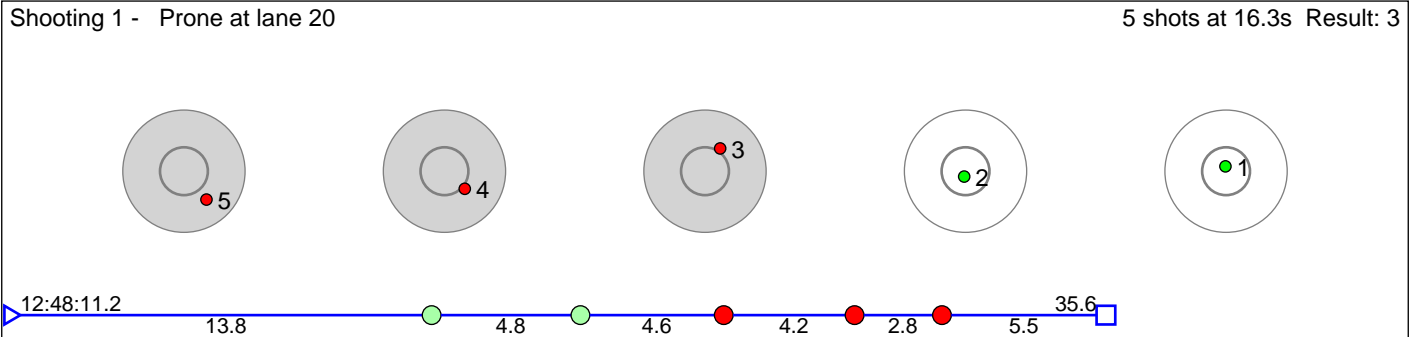

Disclaimer:

These results are unofficial since only the final output from the timing system can provide complete and correct competition results. The graphic plot of each series, presents the location of the shots on each of the five targets. Please observe that the accuracy of the plotting has some limitations due to image resolution and/or printer quality.

82 LÃyning Rannveig Oma

Odda IL

Result: 14

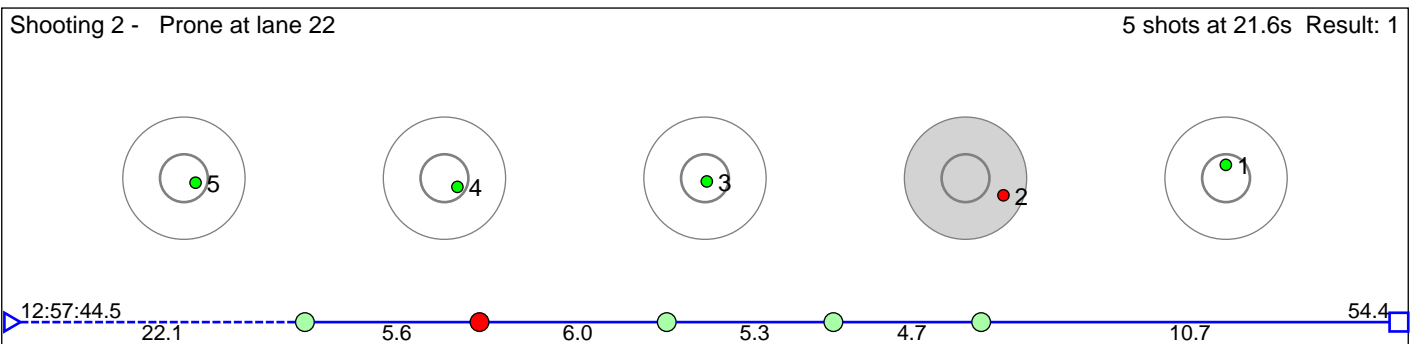
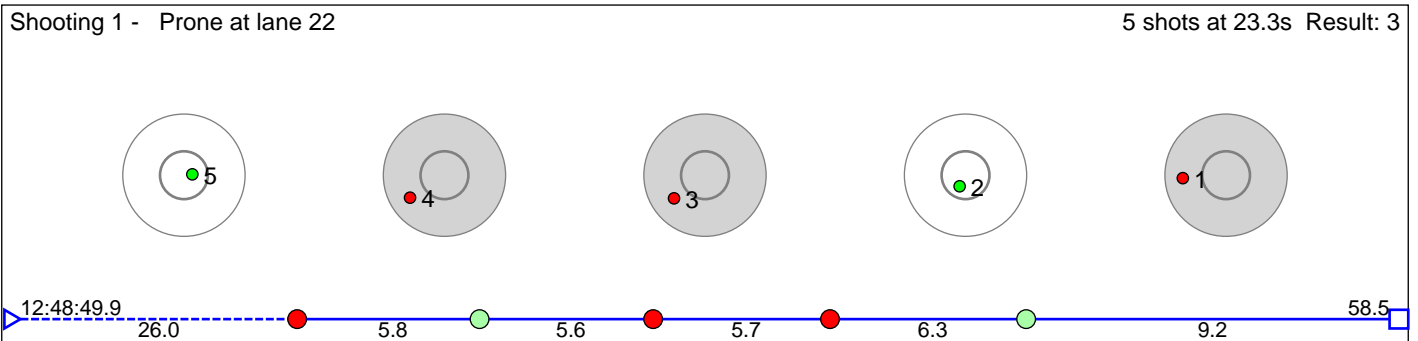

Disclaimer:

These results are unofficial since only the final output from the timing system can provide complete and correct competition results. The graphic plot of each series, presents the location of the shots on each of the five targets. Please observe that the accuracy of the plotting has some limitations due to image resolution and/or printer quality.

83 Eide Hilda Viskjer

Odda IL

Result: 11

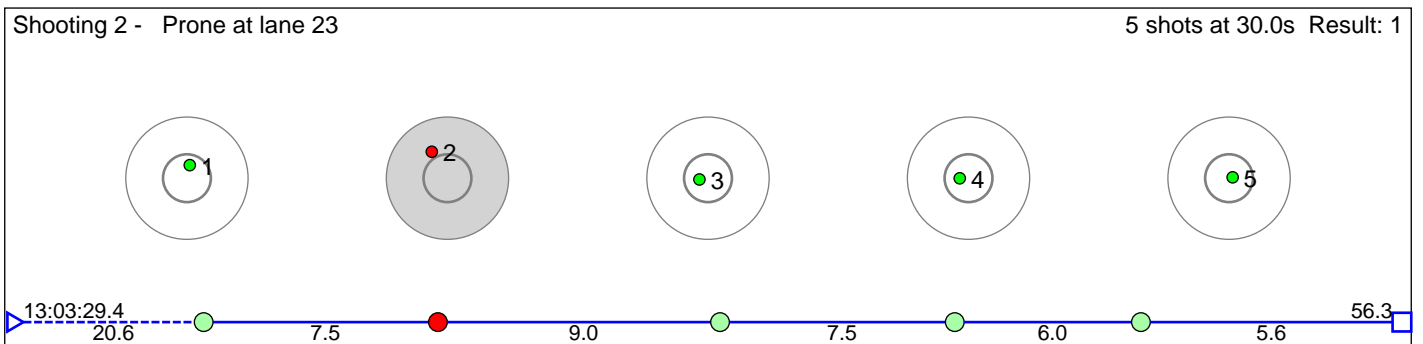
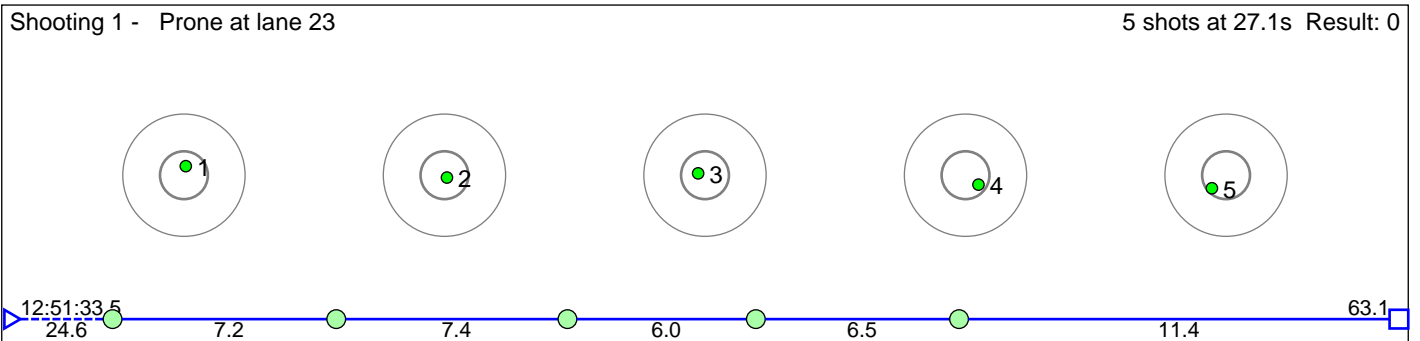

Disclaimer:

These results are unofficial since only the final output from the timing system can provide complete and correct competition results. The graphic plot of each series, presents the location of the shots on each of the five targets. Please observe that the accuracy of the plotting has some limitations due to image resolution and/or printer quality.

85 Hopsnes Kristin

Fana IL

Result: 12

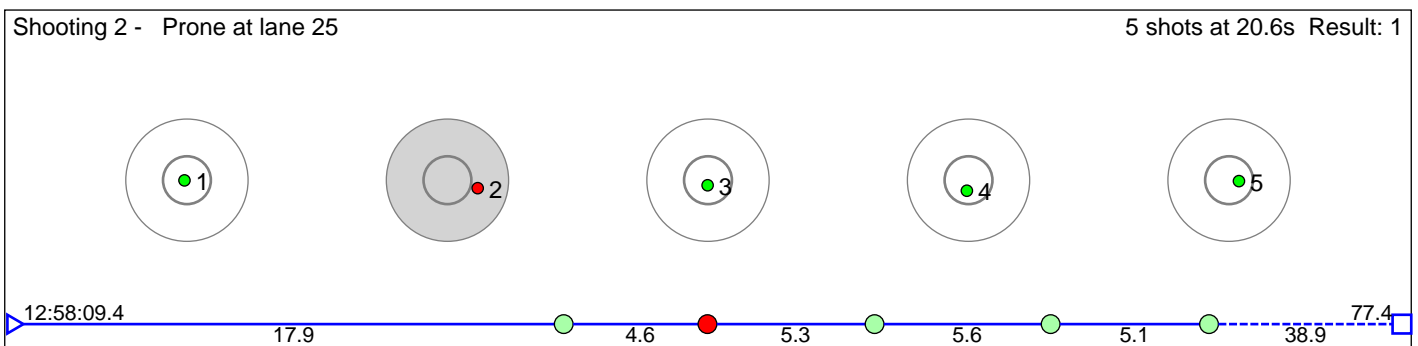
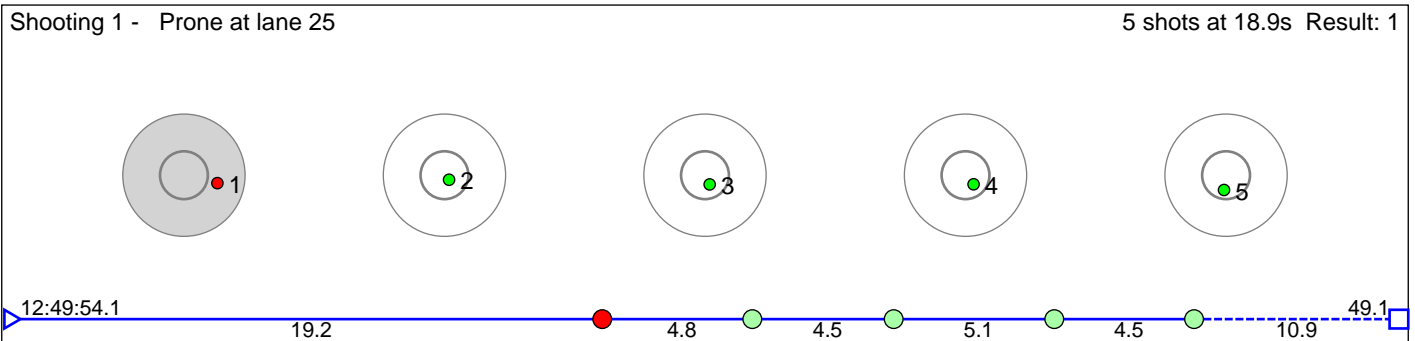

Disclaimer:

These results are unofficial since only the final output from the timing system can provide complete and correct competition results. The graphic plot of each series, presents the location of the shots on each of the five targets. Please observe that the accuracy of the plotting has some limitations due to image resolution and/or printer quality.

87 SÅ, reng Mathias Gravelstølter

Fana IL

Result: 14

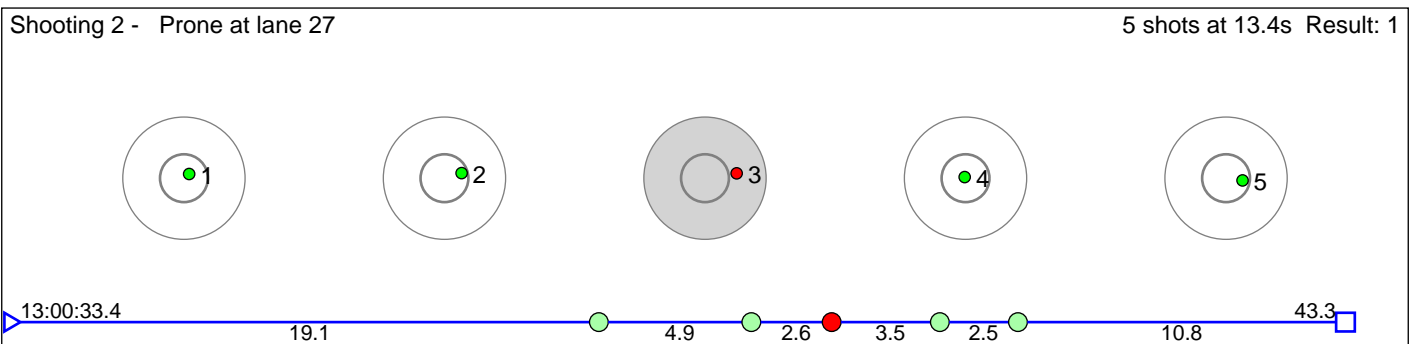
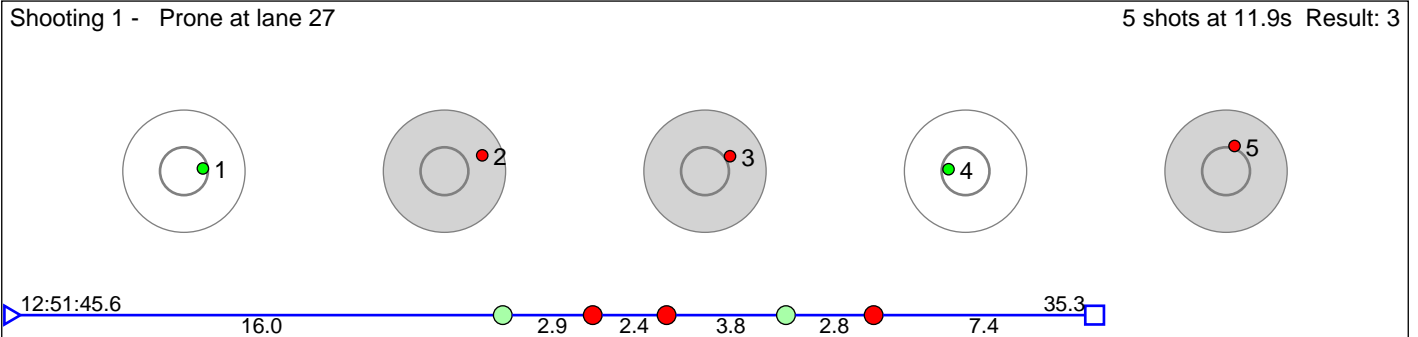

Disclaimer:

These results are unofficial since only the final output from the timing system can provide complete and correct competition results. The graphic plot of each series, presents the location of the shots on each of the five targets. Please observe that the accuracy of the plotting has some limitations due to image resolution and/or printer quality.

88 RÅ_d Alexander Å svang

HÅlandsdal IL

Result: 17

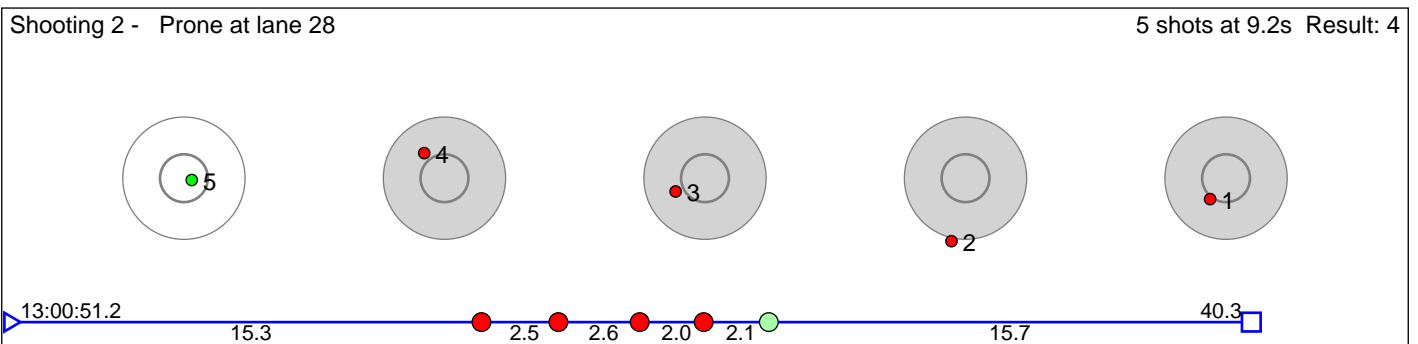
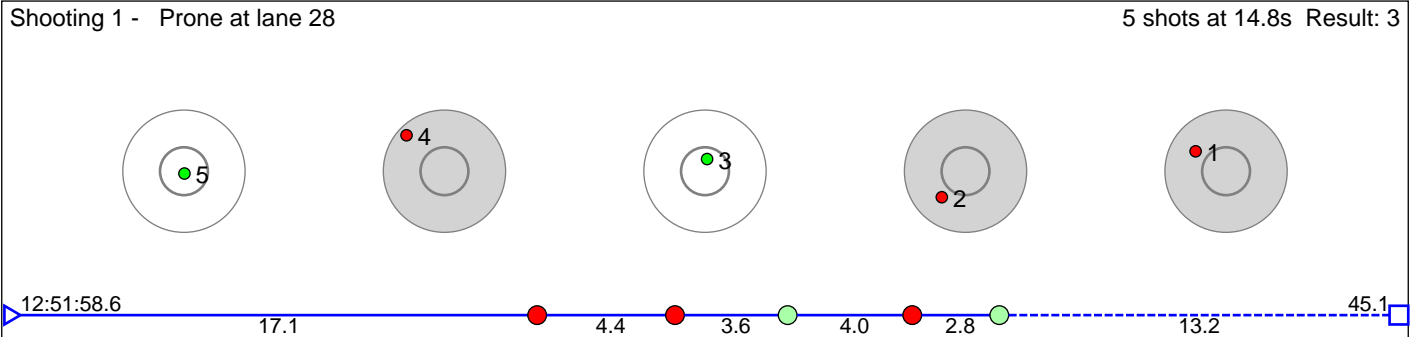

Disclaimer:

These results are unofficial since only the final output from the timing system can provide complete and correct competition results. The graphic plot of each series, presents the location of the shots on each of the five targets. Please observe that the accuracy of the plotting has some limitations due to image resolution and/or printer quality.

92 Vaksdal Kristian Fosse

Voss Skiskytterlag

Result: 13

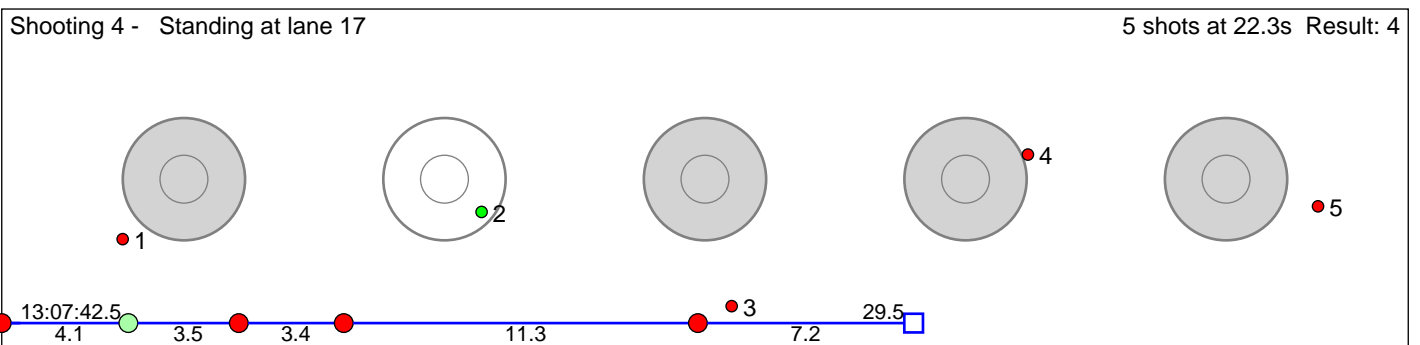
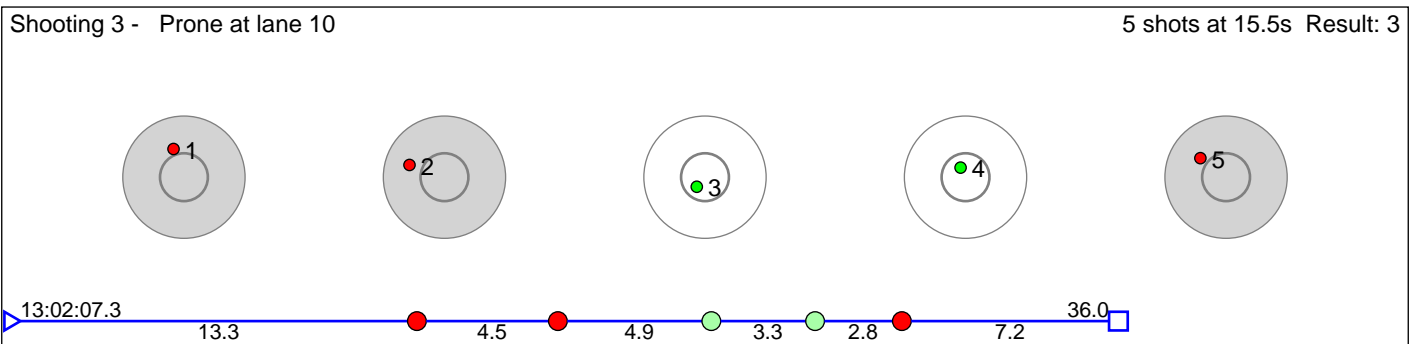
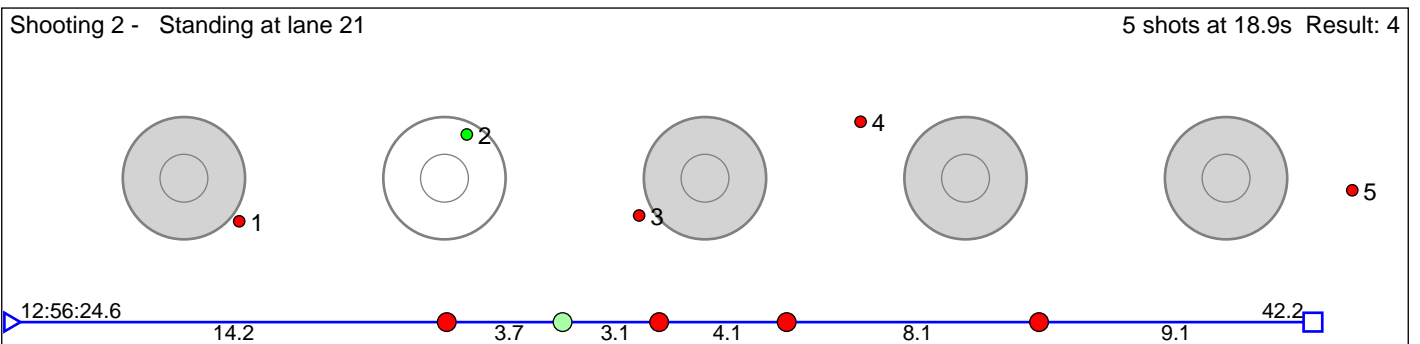
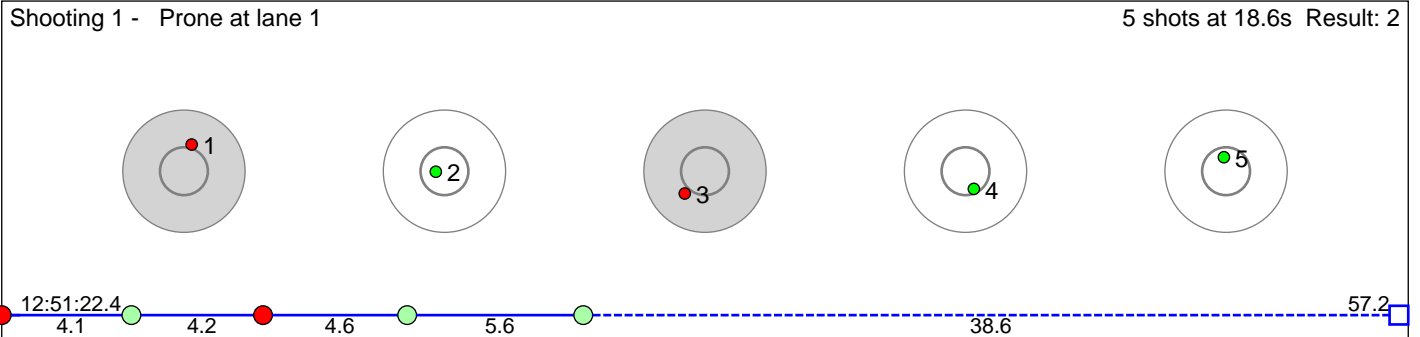

Disclaimer:

These results are unofficial since only the final output from the timing system can provide complete and correct competition results. The graphic plot of each series, presents the location of the shots on each of the five targets. Please observe that the accuracy of the plotting has some limitations due to image resolution and/or printer quality.

93 Vik Sander Tennebekk

Voss IL

Result: 3

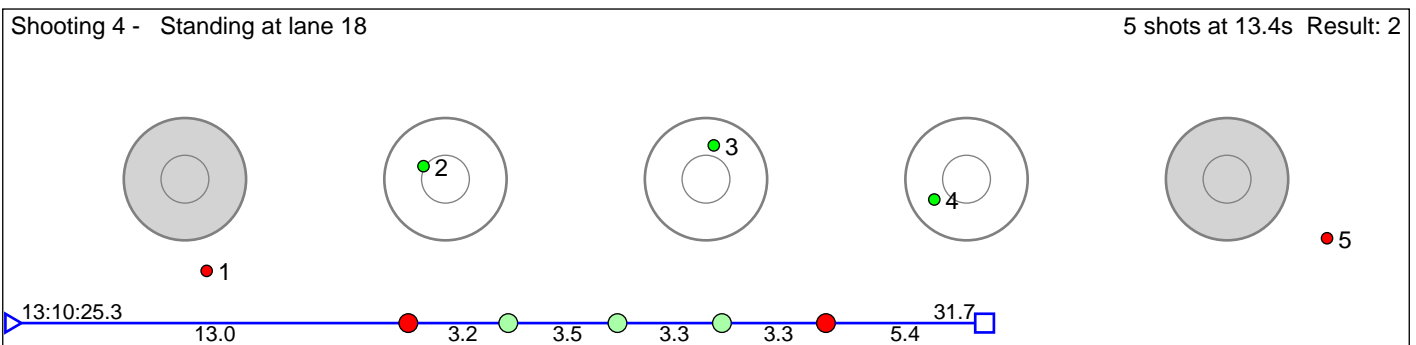
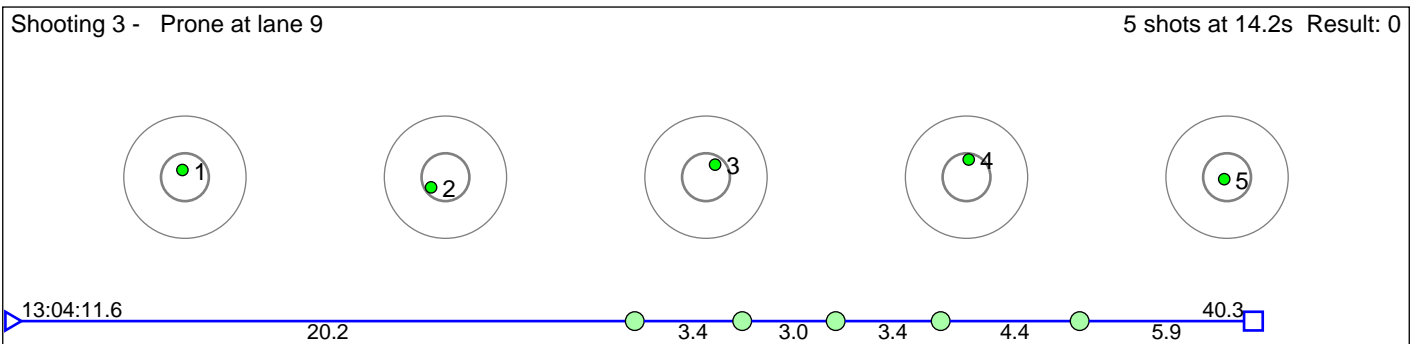
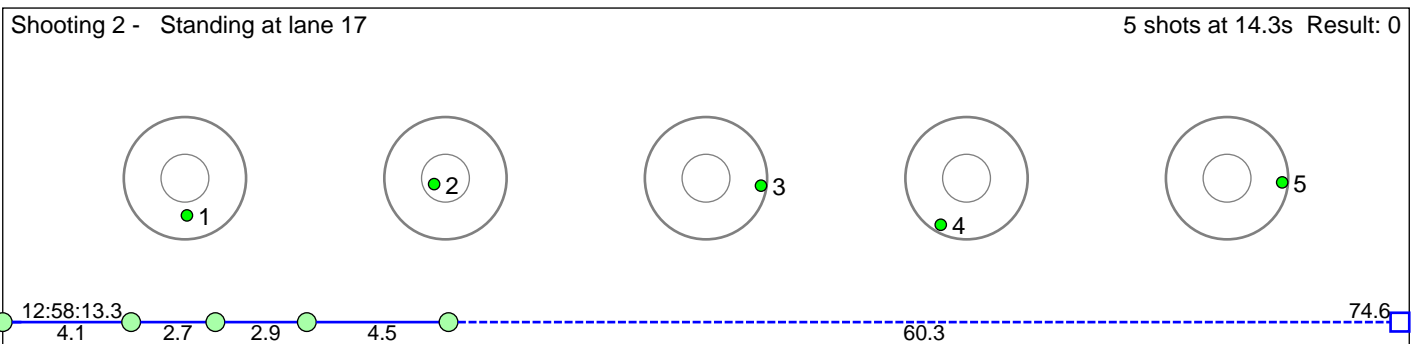
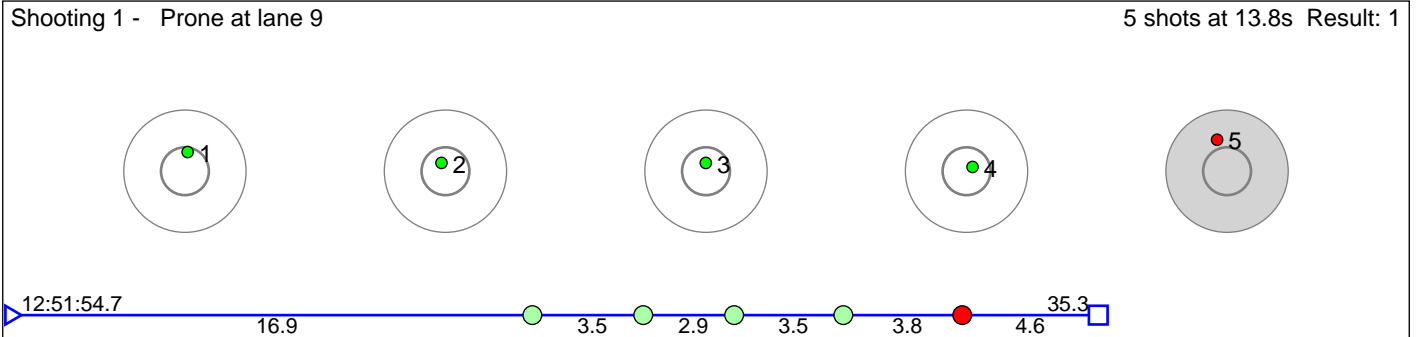

Disclaimer:

These results are unofficial since only the final output from the timing system can provide complete and correct competition results. The graphic plot of each series, presents the location of the shots on each of the five targets. Please observe that the accuracy of the plotting has some limitations due to image resolution and/or printer quality.

95 Almeland Andrea SÃ¸rheim

Kvam Langrenn- og Skiskyttarklubb

Result: 6

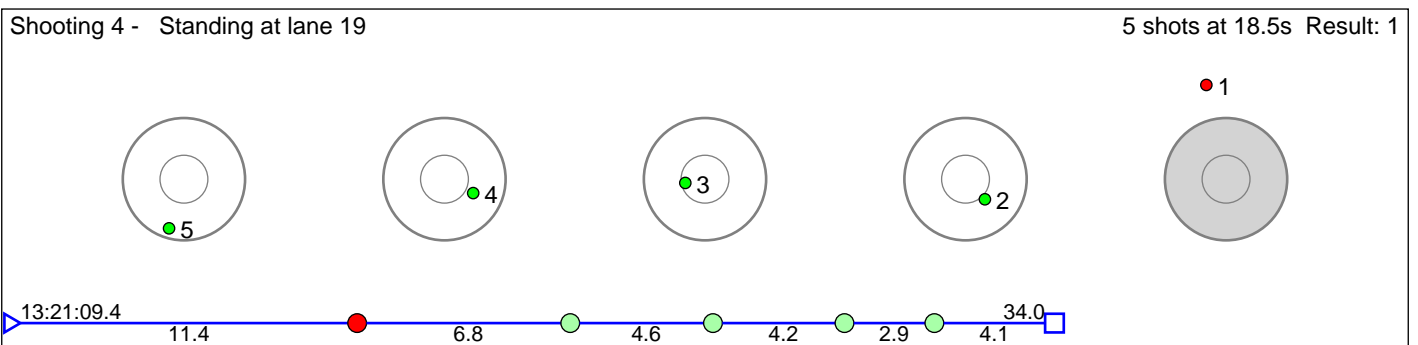
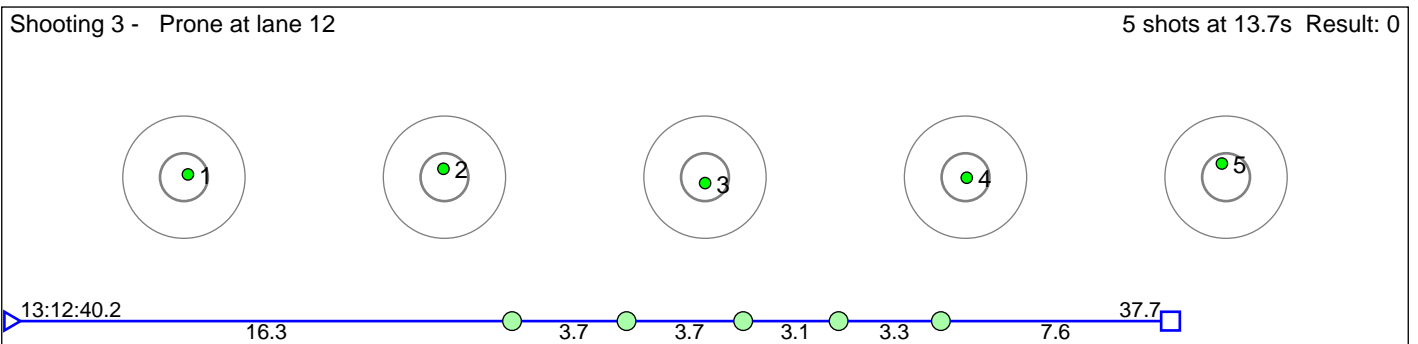
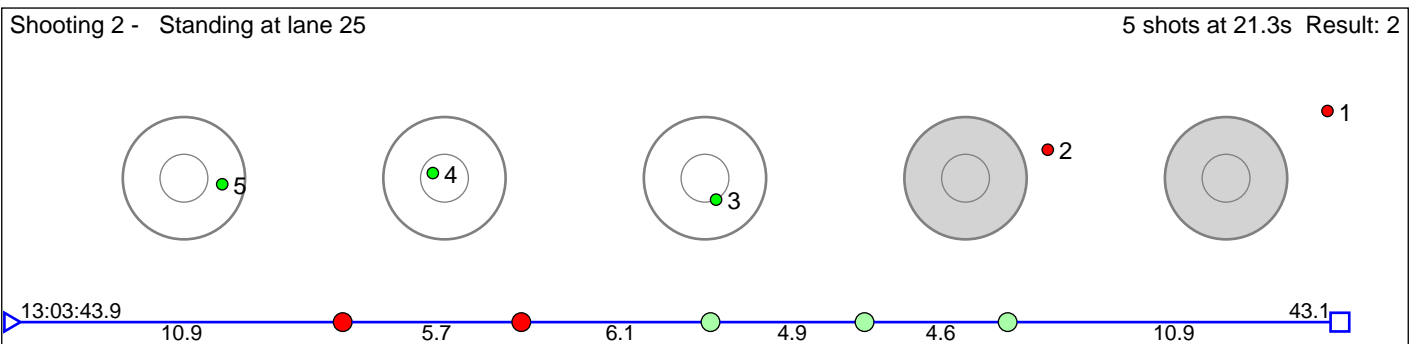
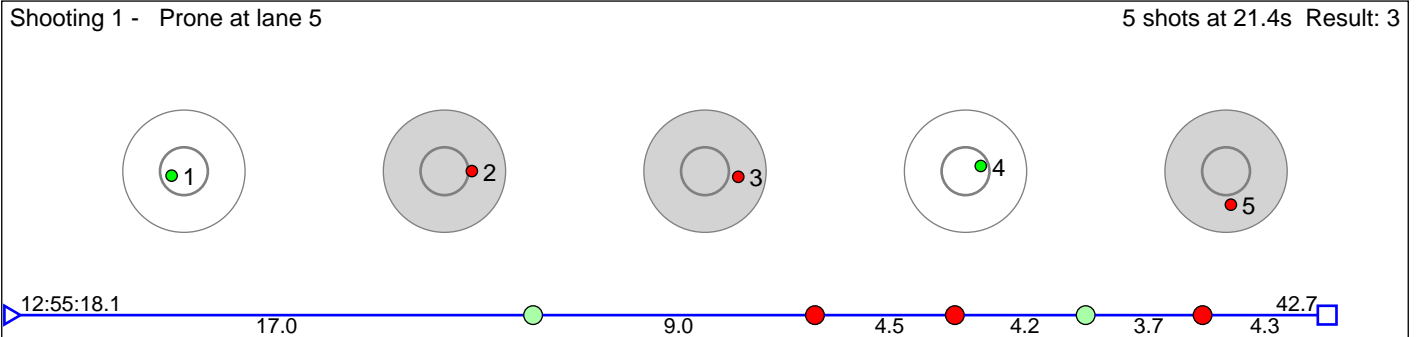

Disclaimer:

These results are unofficial since only the final output from the timing system can provide complete and correct competition results. The graphic plot of each series, presents the location of the shots on each of the five targets. Please observe that the accuracy of the plotting has some limitations due to image resolution and/or printer quality.

96 Mo Hedda HÅ, en

Kvam Langrenn- og Skiskyttarklubb

Result: 4

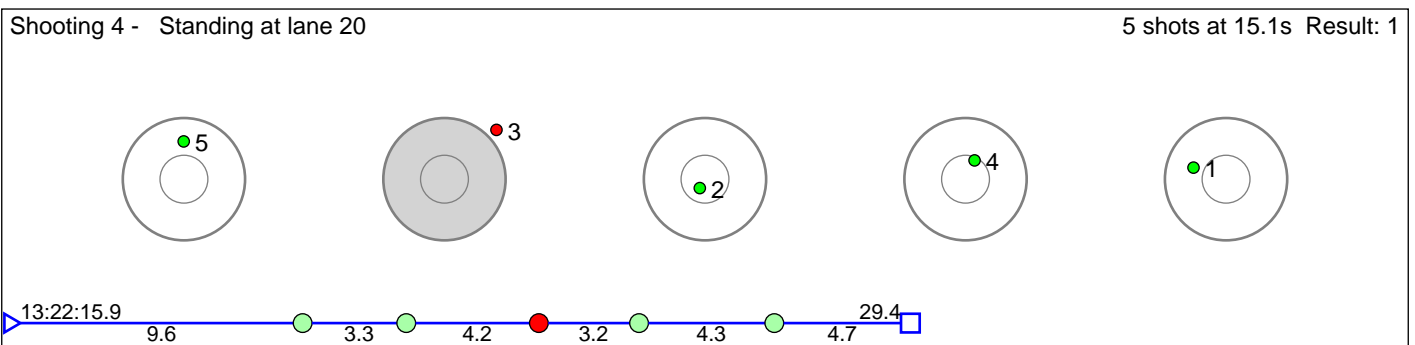
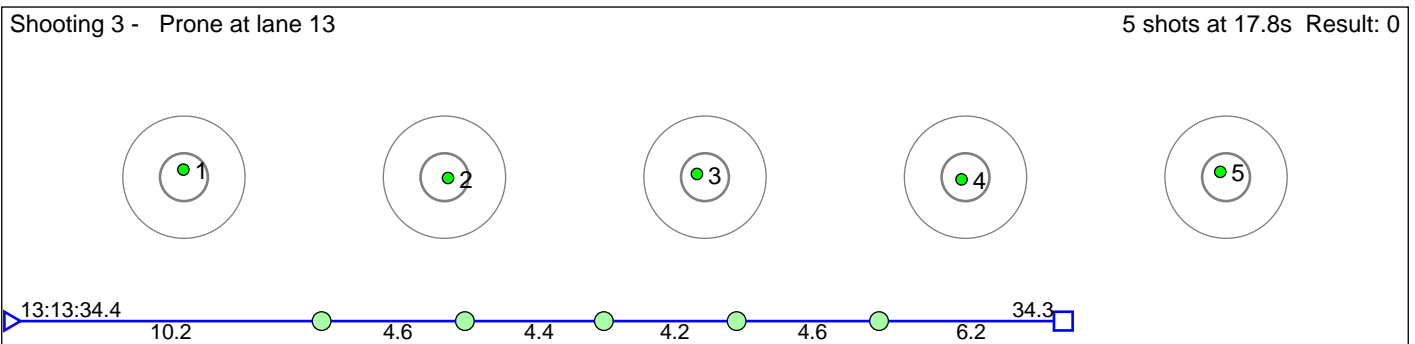
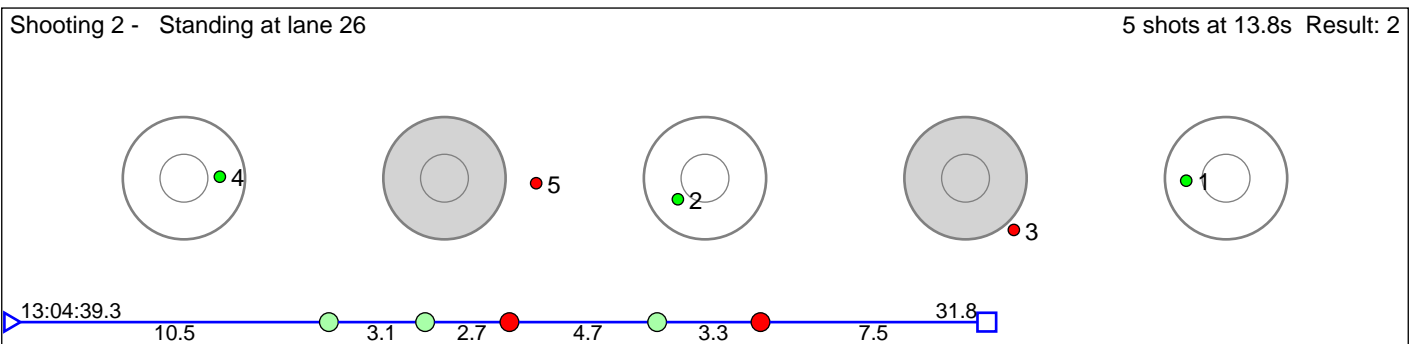
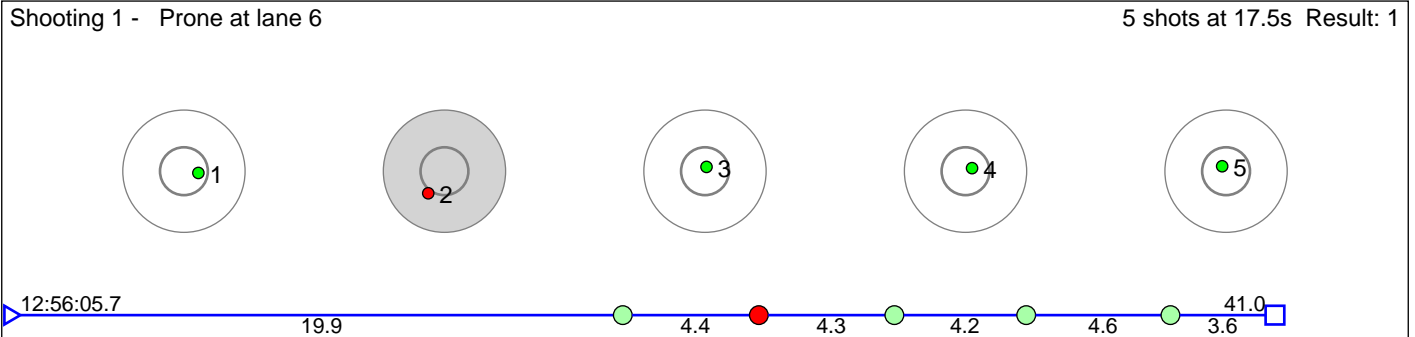

Disclaimer:

These results are unofficial since only the final output from the timing system can provide complete and correct competition results. The graphic plot of each series, presents the location of the shots on each of the five targets. Please observe that the accuracy of the plotting has some limitations due to image resolution and/or printer quality.

97 Garverhaugen Juni Iselin

Fana IL

Result: 6

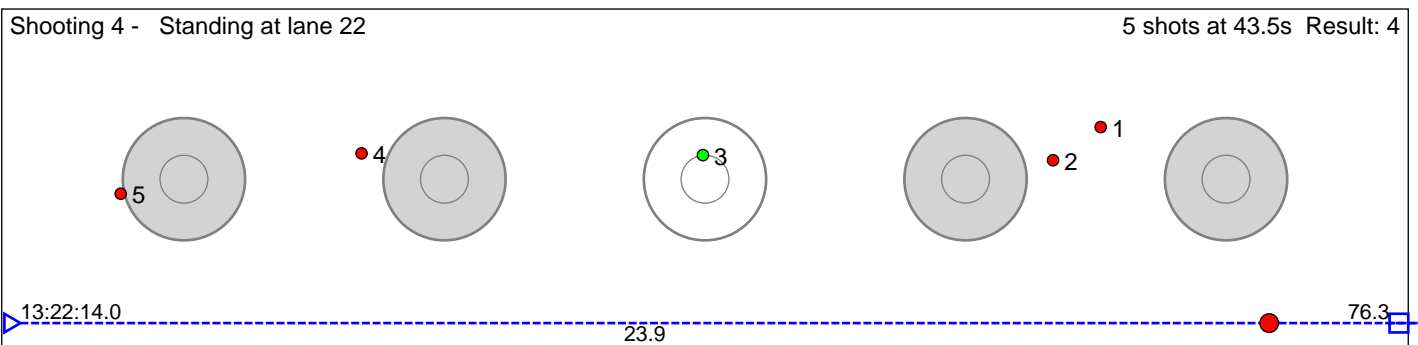
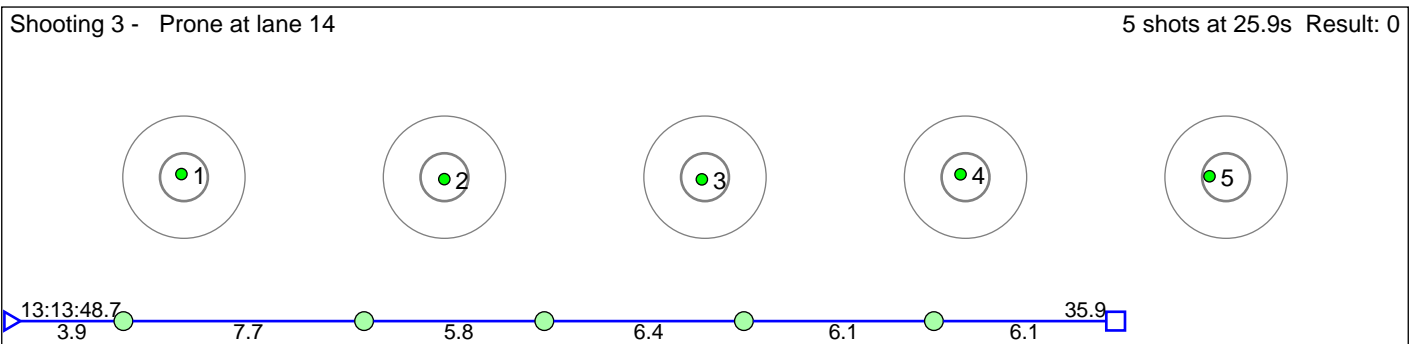
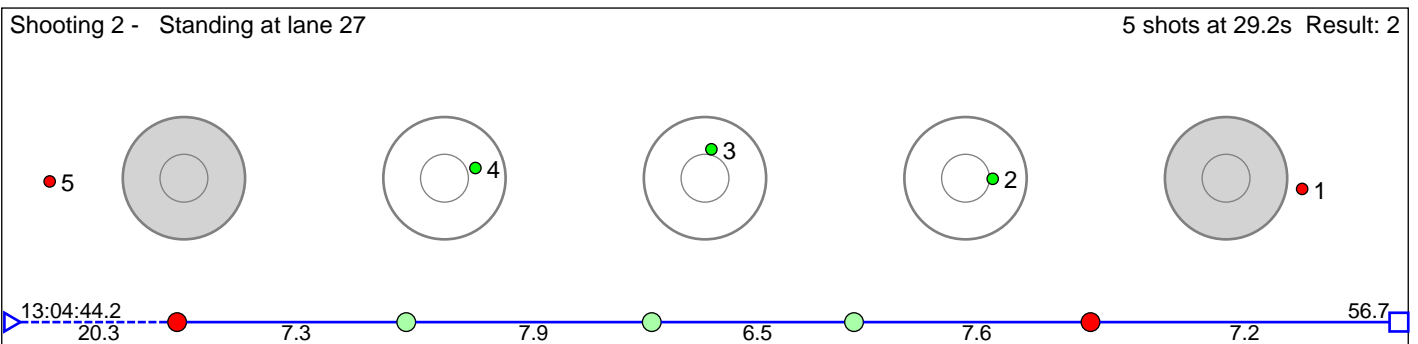
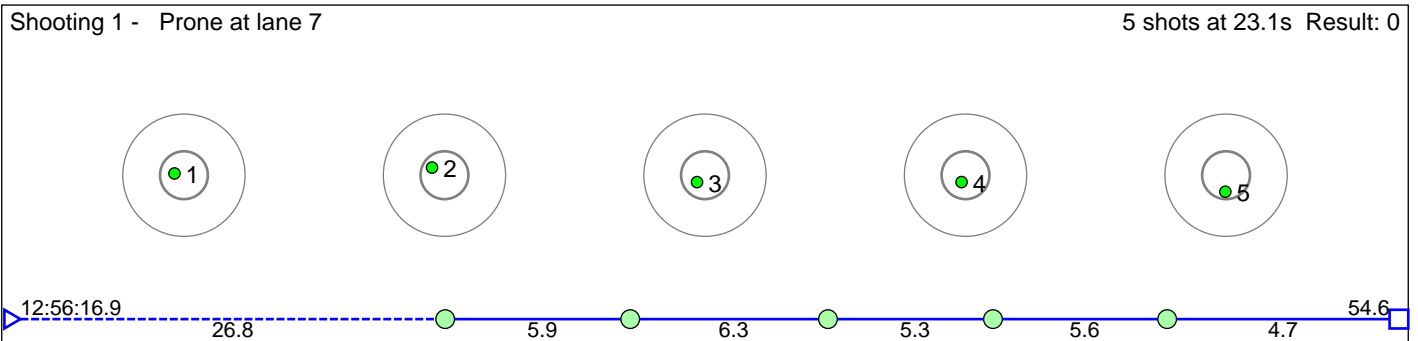

Disclaimer:

These results are unofficial since only the final output from the timing system can provide complete and correct competition results. The graphic plot of each series, presents the location of the shots on each of the five targets. Please observe that the accuracy of the plotting has some limitations due to image resolution and/or printer quality.

98 Jordal Ida FlatabÃ,

Odda IL

Result: 5

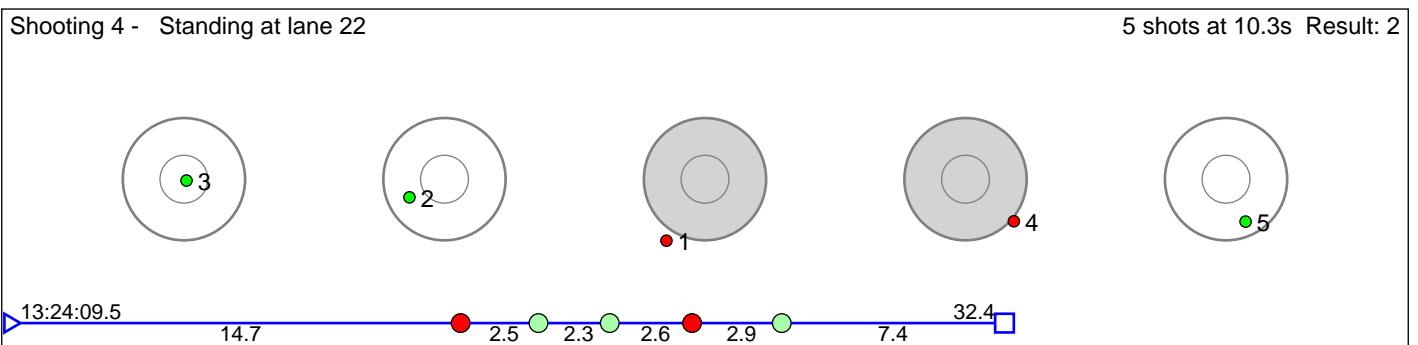
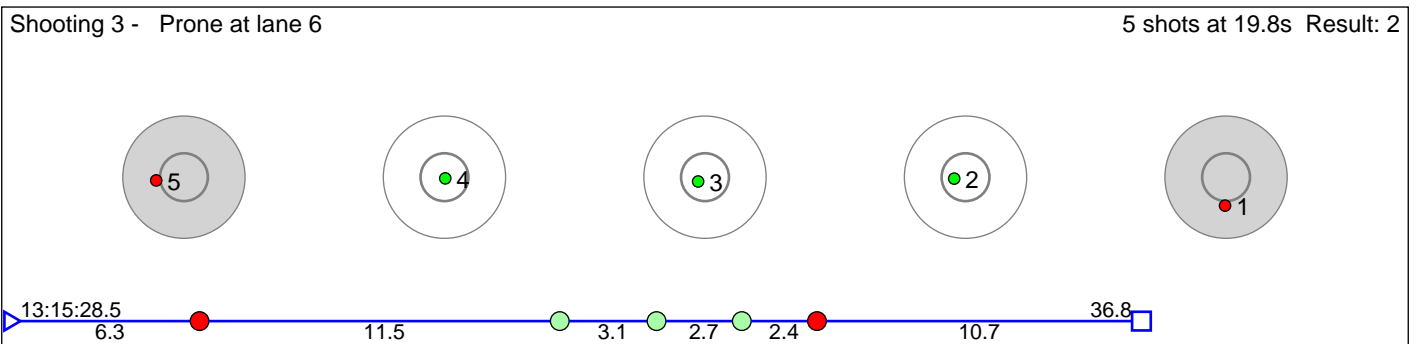
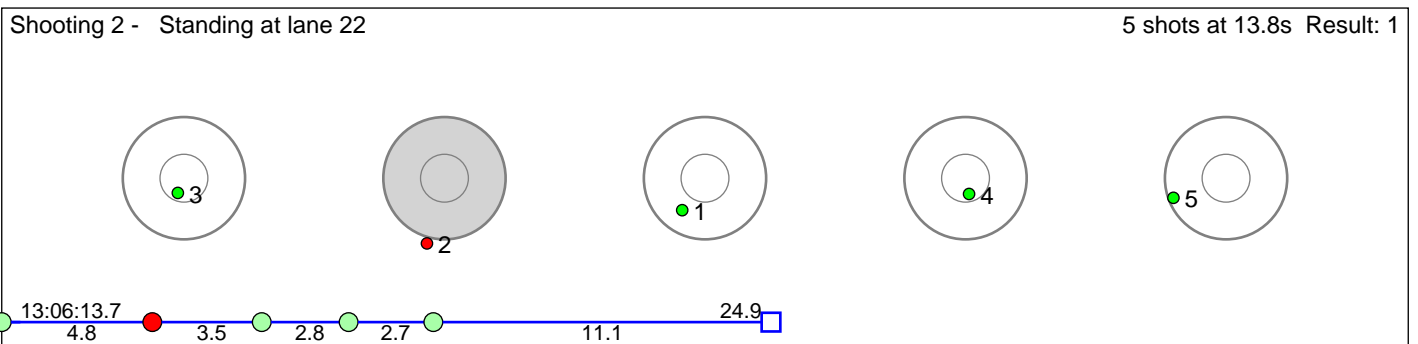
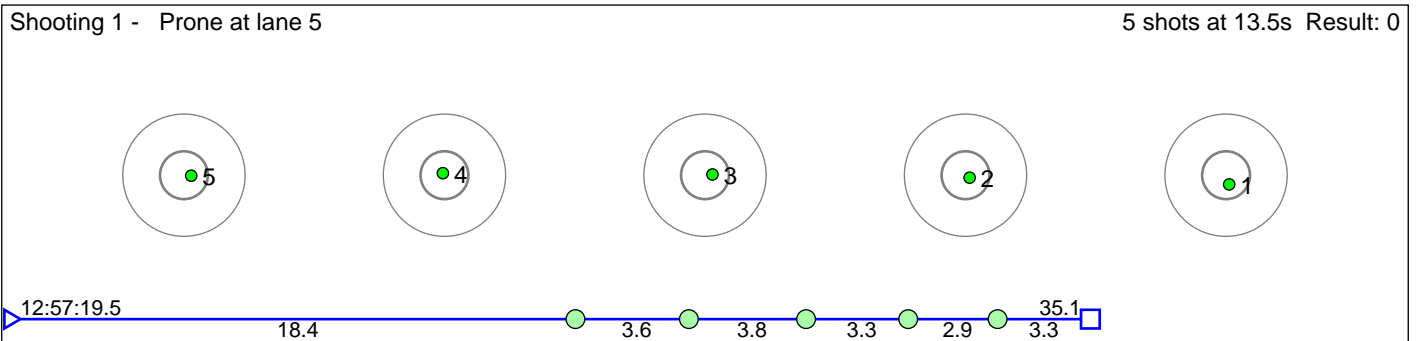

Disclaimer:

These results are unofficial since only the final output from the timing system can provide complete and correct competition results. The graphic plot of each series, presents the location of the shots on each of the five targets. Please observe that the accuracy of the plotting has some limitations due to image resolution and/or printer quality.

100 SÅ, Ilesvik Isak Solli

HÅÏlandsdal IL

Result: 6

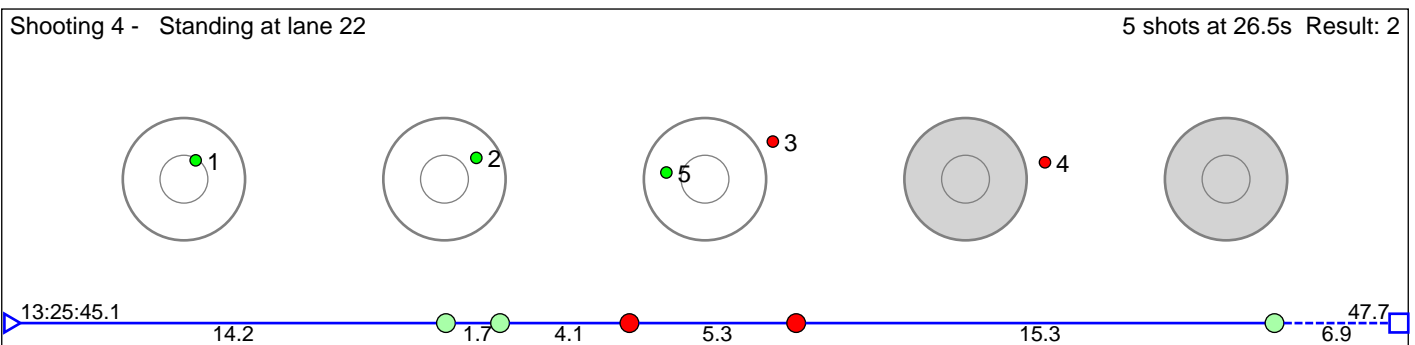
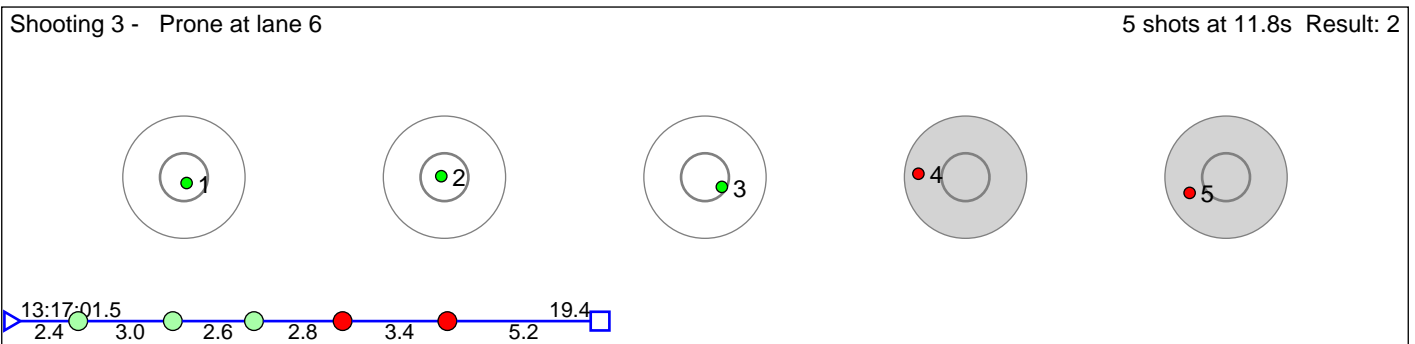
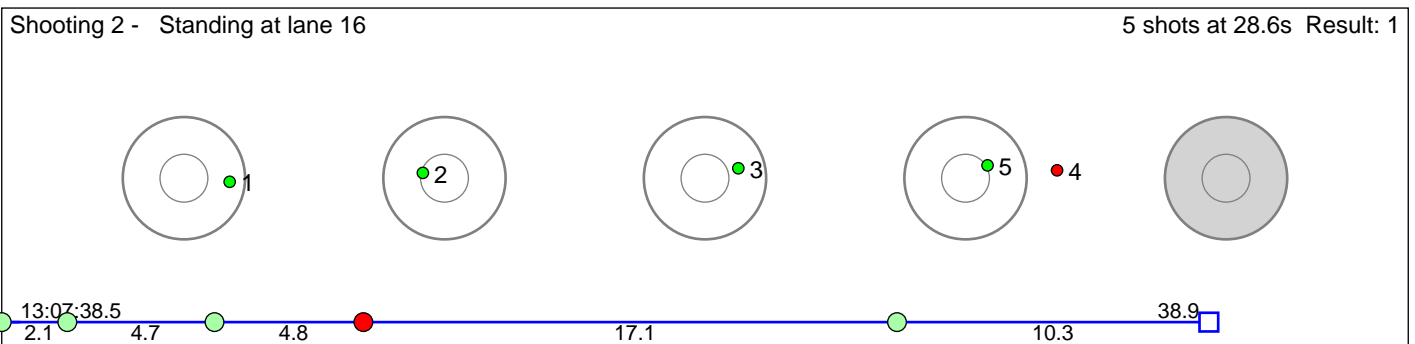
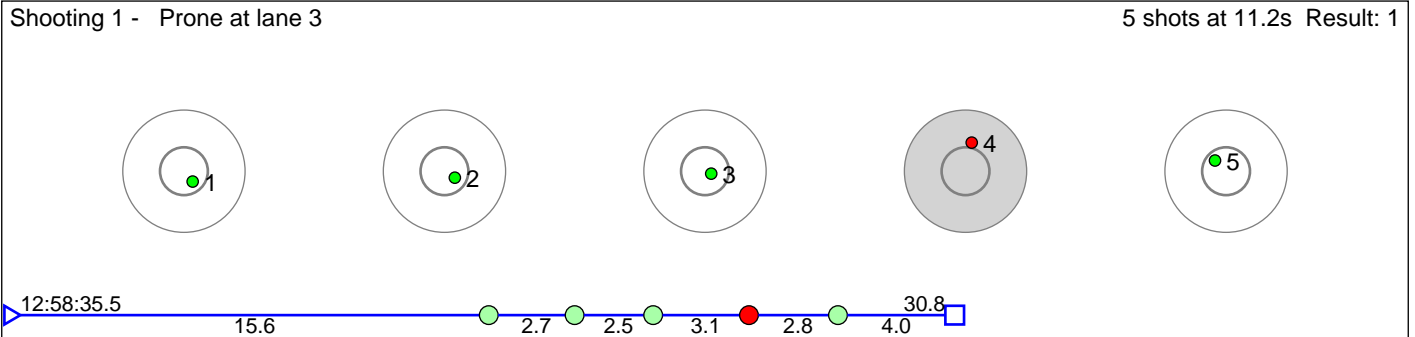

Disclaimer:

These results are unofficial since only the final output from the timing system can provide complete and correct competition results. The graphic plot of each series, presents the location of the shots on each of the five targets. Please observe that the accuracy of the plotting has some limitations due to image resolution and/or printer quality.

101 Aarseth Andreas

HÅÏlandsdal IL

Result: 8

Shooting 1 - Prone at lane 12 5 shots at 12.9s Result: 0

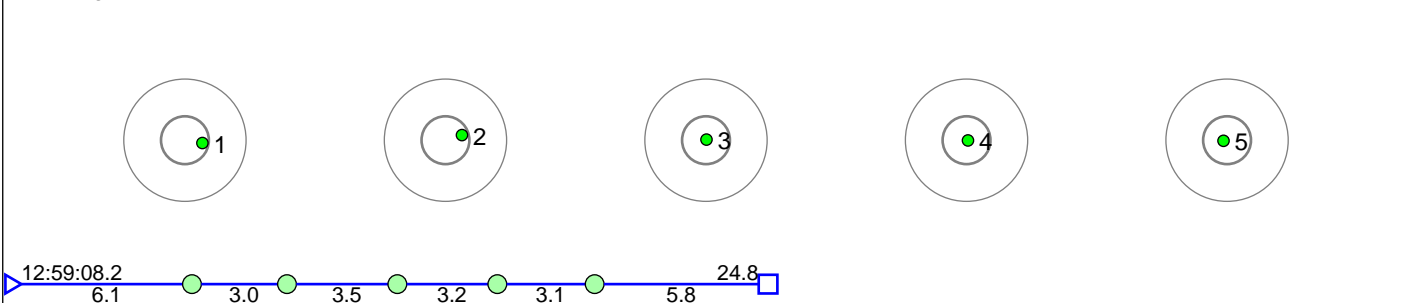

Shooting 2 - Standing at lane 21 5 shots at 11.0s Result: 3

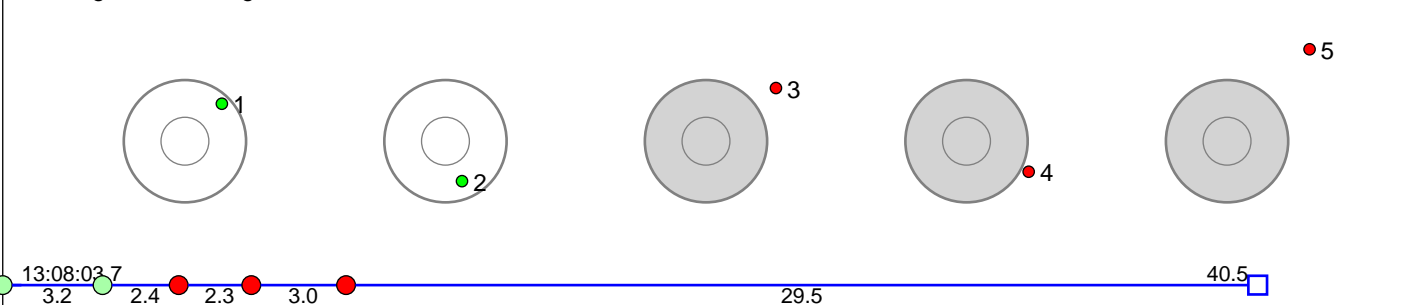

Shooting 3 - Prone at lane 12 5 shots at 13.2s Result: 2

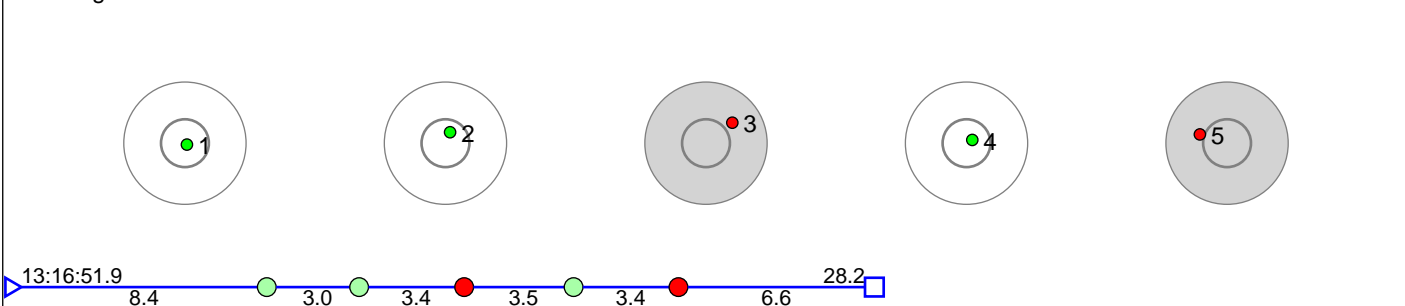

Shooting 4 - Standing at lane 21 5 shots at 12.9s Result: 3

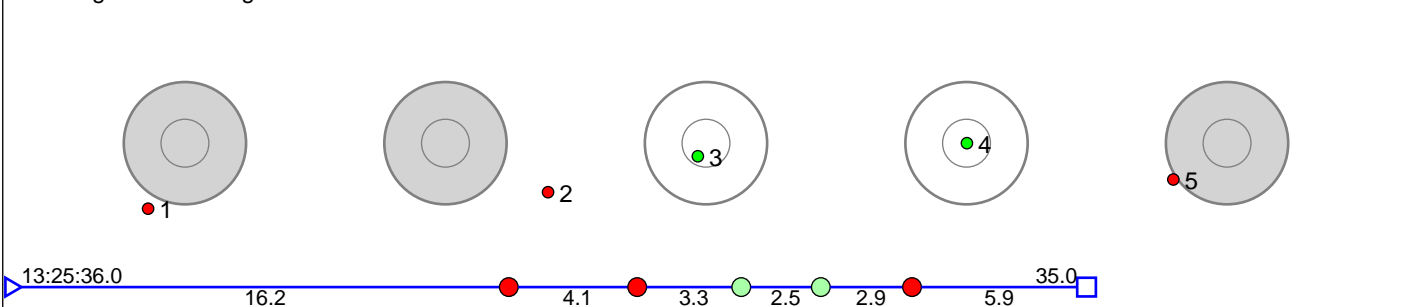

Disclaimer:

These results are unofficial since only the final output from the timing system can provide complete and correct competition results. The graphic plot of each series, presents the location of the shots on each of the five targets. Please observe that the accuracy of the plotting has some limitations due to image resolution and/or printer quality.

103 SÃ,ring Sander GravelstÃ,ter

Fana IL

Result: 10

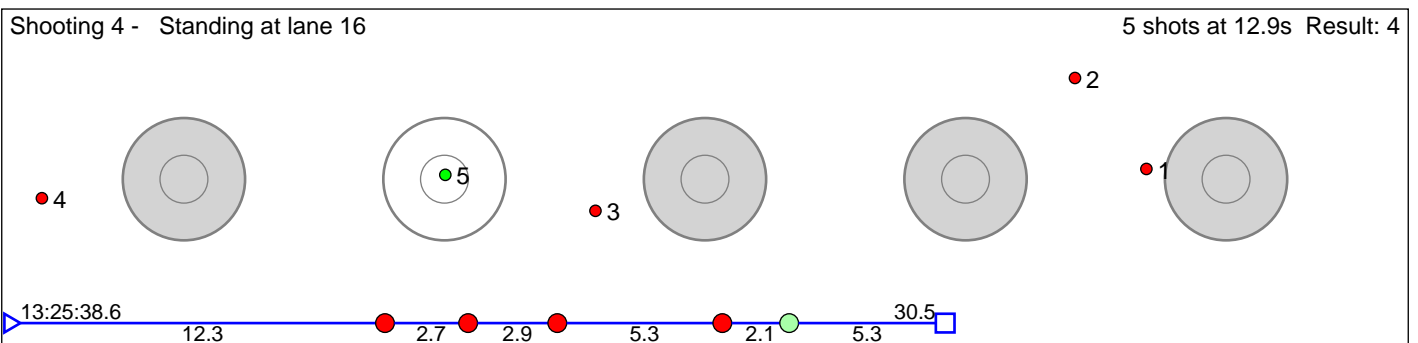
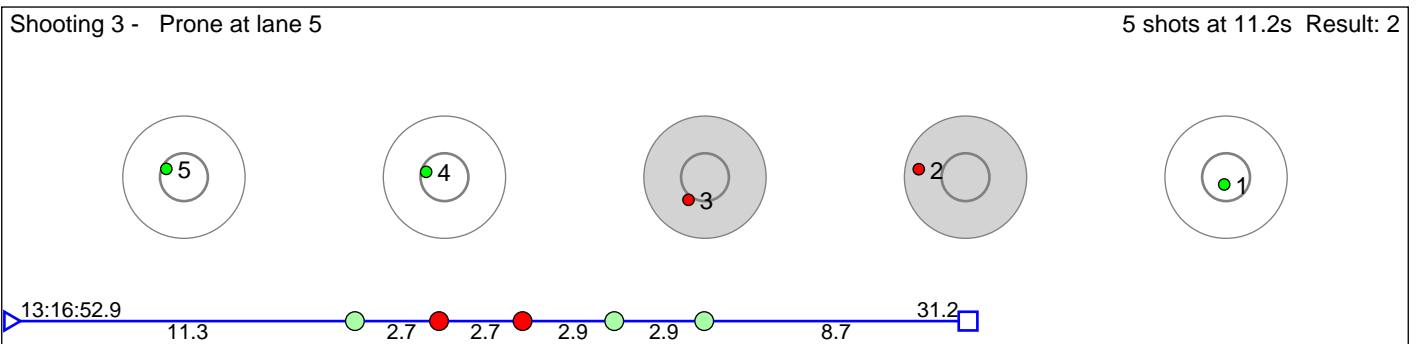
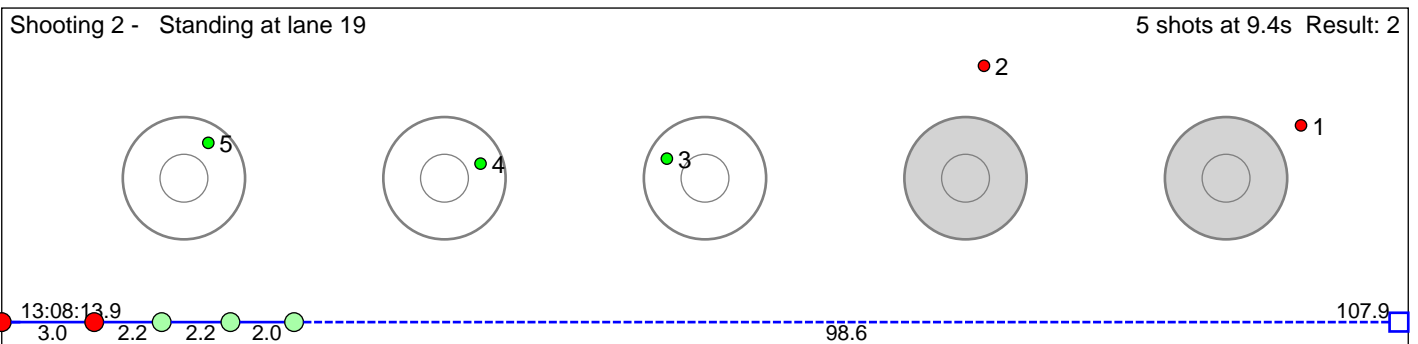
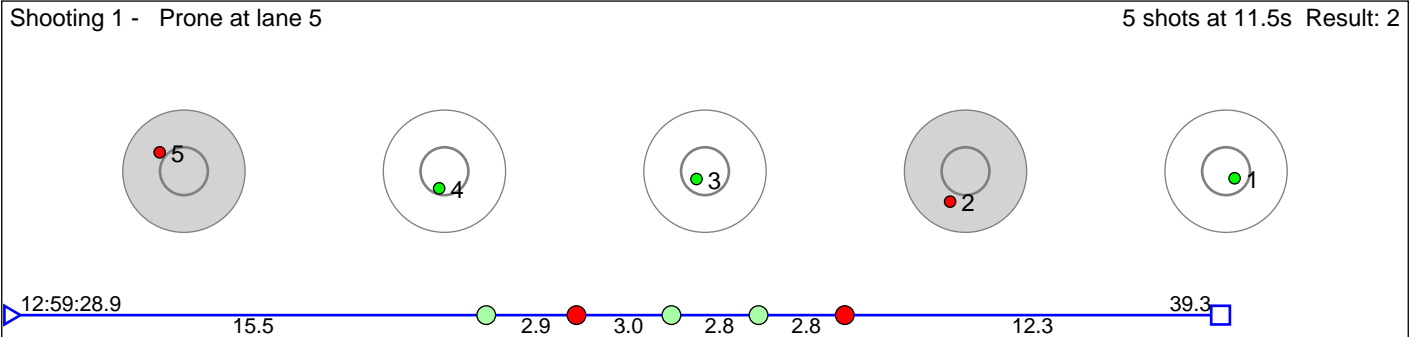

Disclaimer:

These results are unofficial since only the final output from the timing system can provide complete and correct competition results. The graphic plot of each series, presents the location of the shots on each of the five targets. Please observe that the accuracy of the plotting has some limitations due to image resolution and/or printer quality.

104 Andreassen Marcus Lernes

HÅÏlandsdal IL

Result: 6

Shooting 1 - Prone at lane 15 5 shots at 10.2s Result: 0

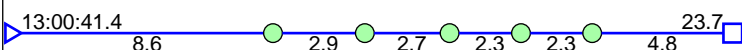
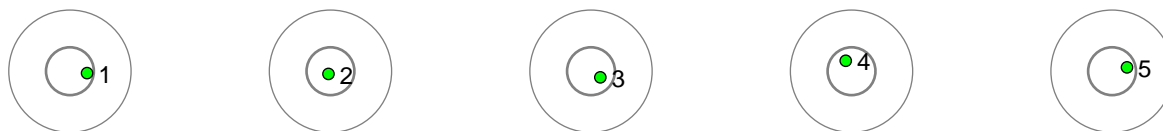

Shooting 2 - Standing at lane 25 5 shots at 8.9s Result: 2

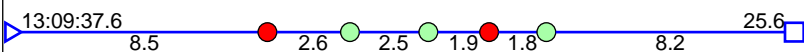
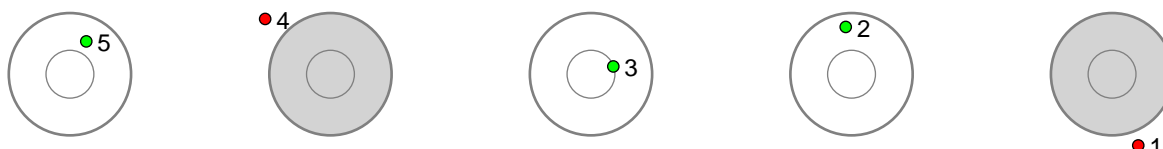

Shooting 3 - Prone at lane 15 5 shots at 9.2s Result: 2

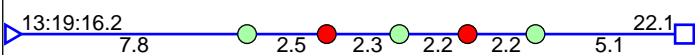
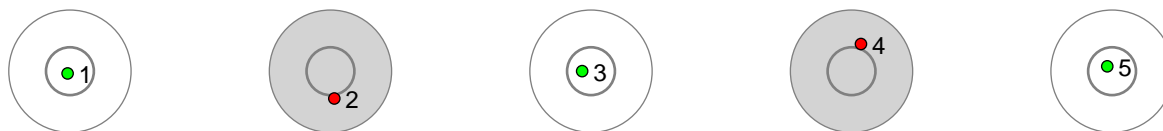

Shooting 4 - Standing at lane 22 5 shots at 6.6s Result: 2

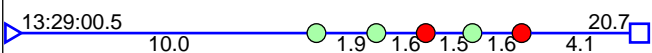
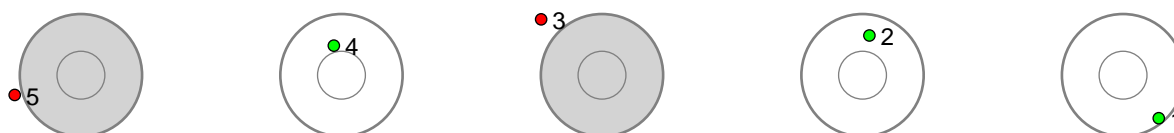

Disclaimer:

These results are unofficial since only the final output from the timing system can provide complete and correct competition results. The graphic plot of each series, presents the location of the shots on each of the five targets. Please observe that the accuracy of the plotting has some limitations due to image resolution and/or printer quality.

105

Result: 3

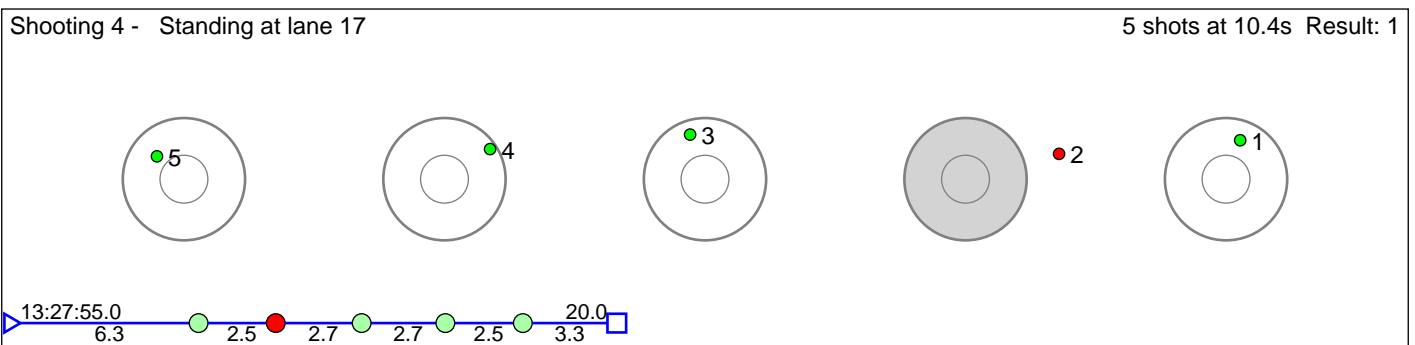
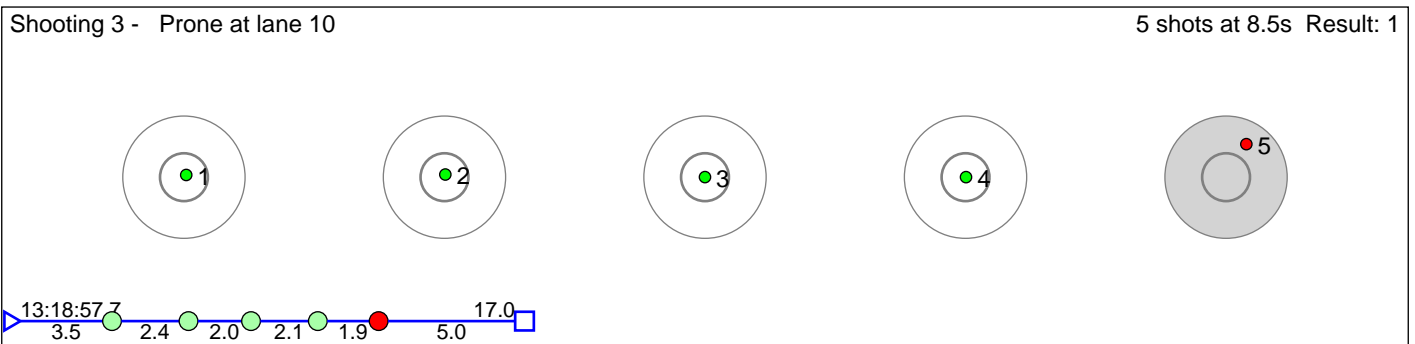
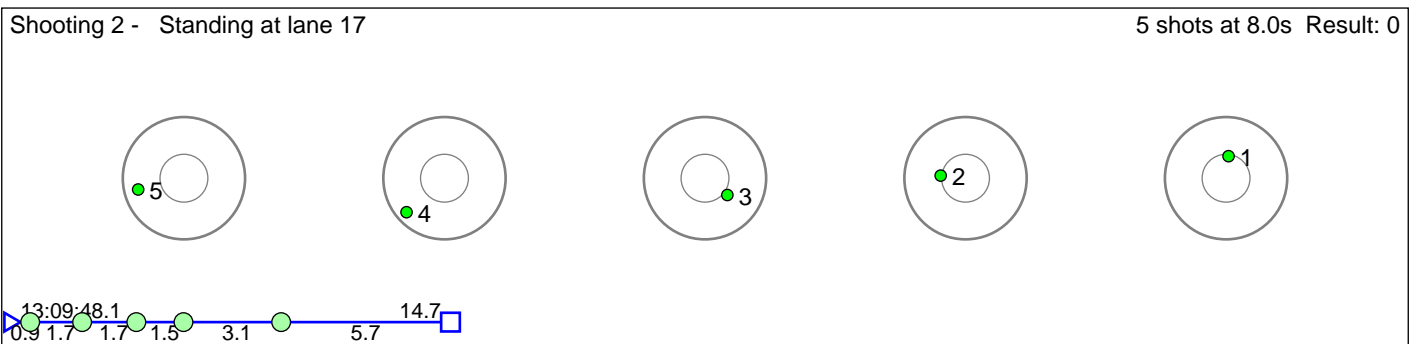
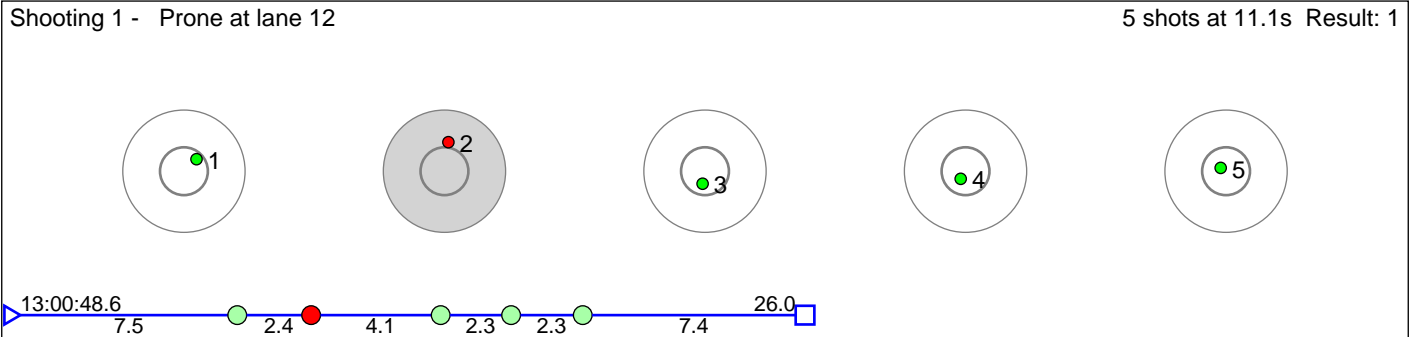

Disclaimer:

These results are unofficial since only the final output from the timing system can provide complete and correct competition results. The graphic plot of each series, presents the location of the shots on each of the five targets. Please observe that the accuracy of the plotting has some limitations due to image resolution and/or printer quality.

106 GjÅ, en Solveig Eikeland

HÅÿlandsdal IL

Result: 4

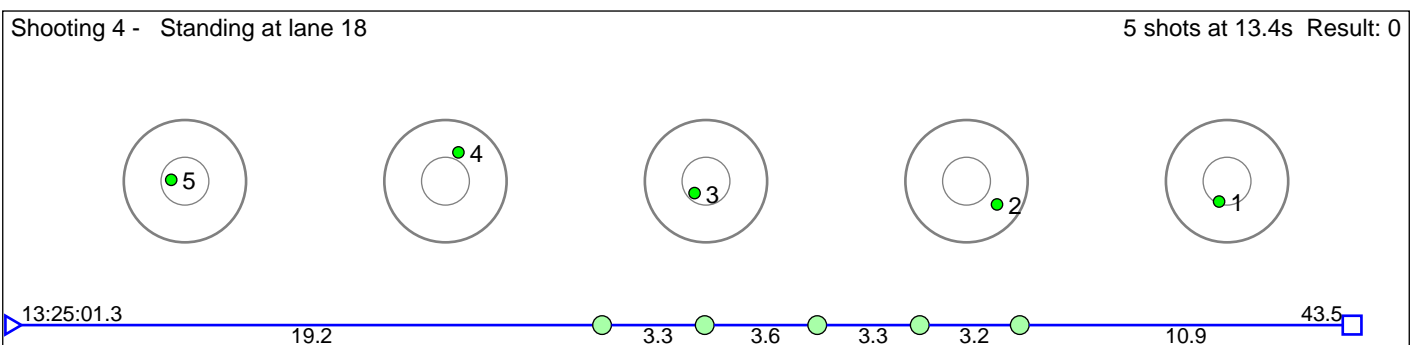
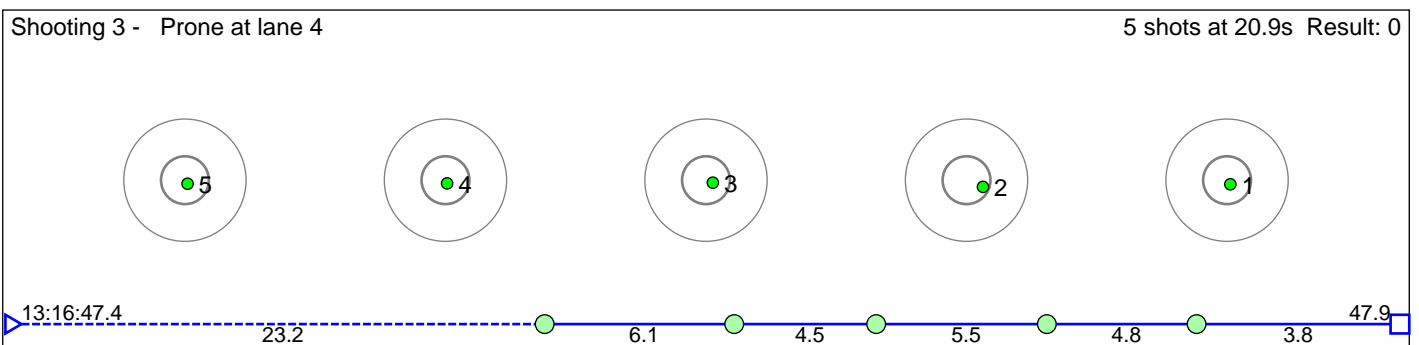
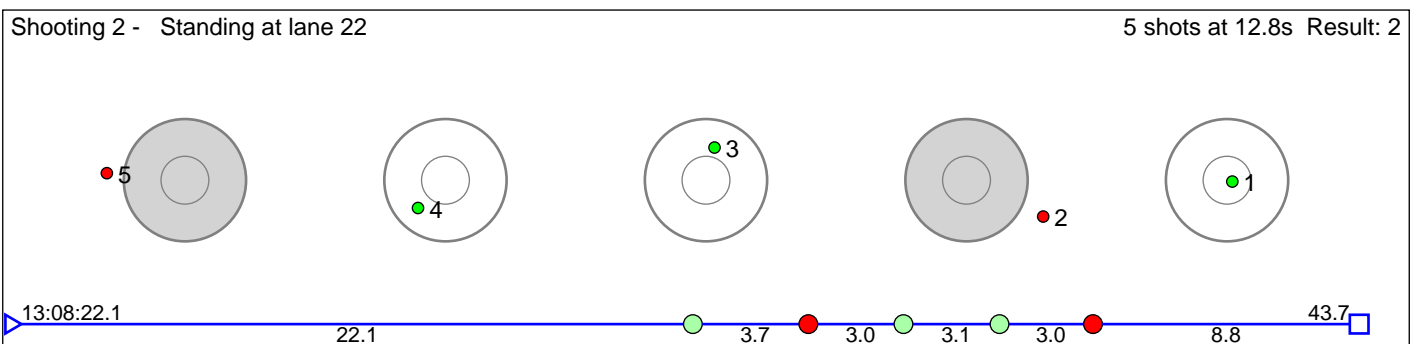
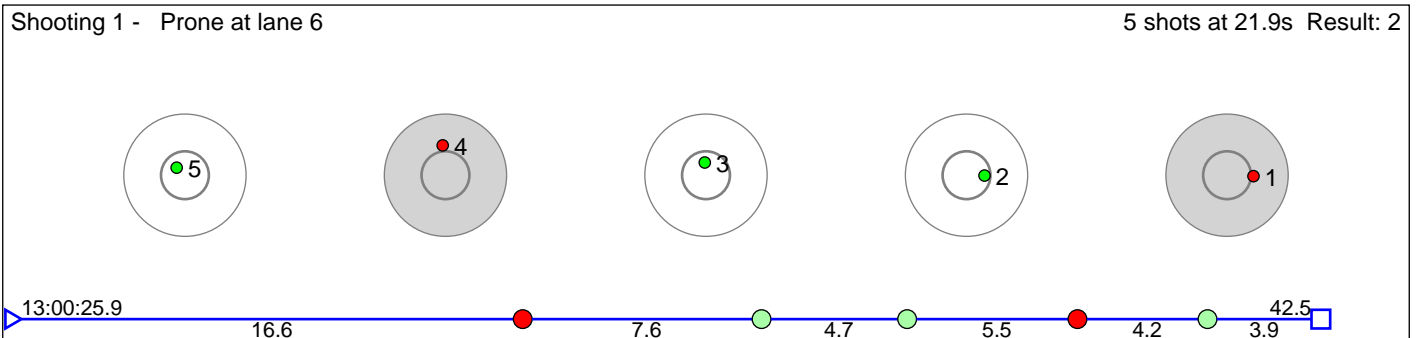

Disclaimer:

These results are unofficial since only the final output from the timing system can provide complete and correct competition results. The graphic plot of each series, presents the location of the shots on each of the five targets. Please observe that the accuracy of the plotting has some limitations due to image resolution and/or printer quality.

107 Femsteinevik Guro

HÅÏlandsdal IL

Result: 3

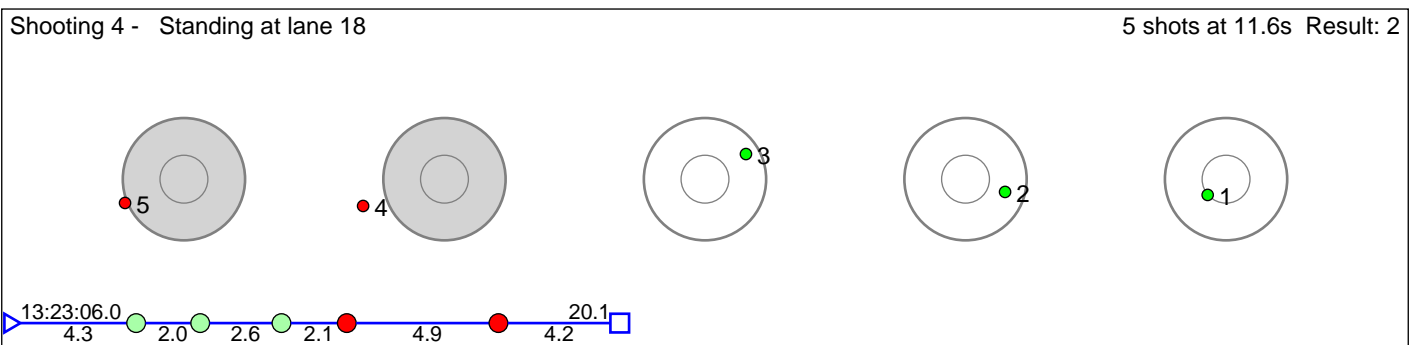
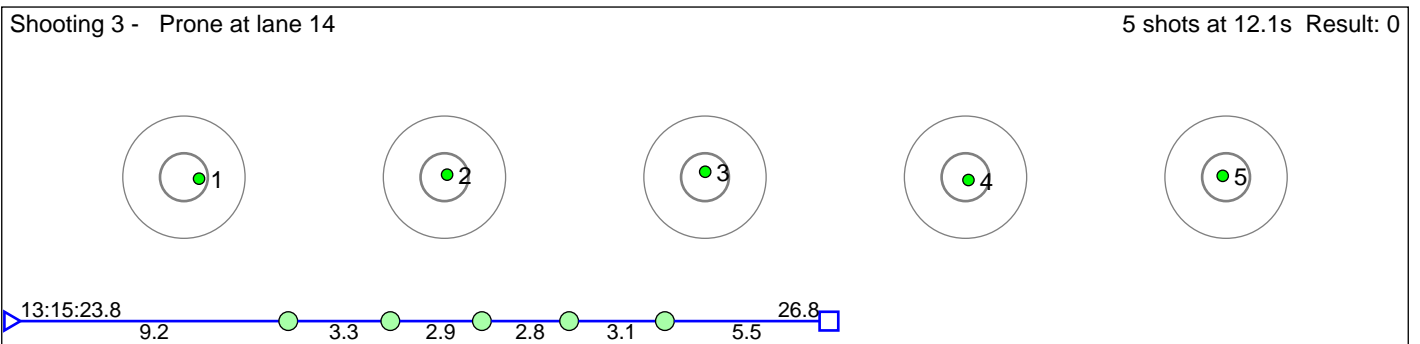
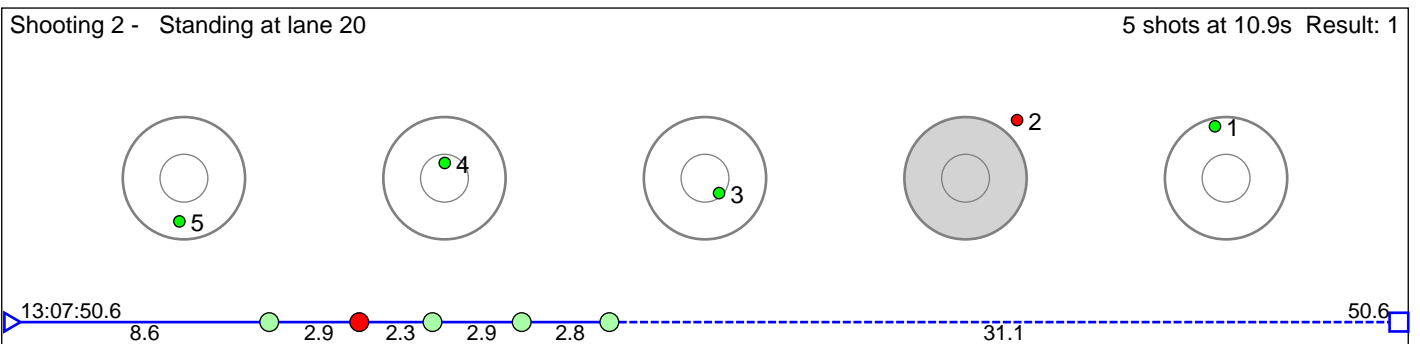
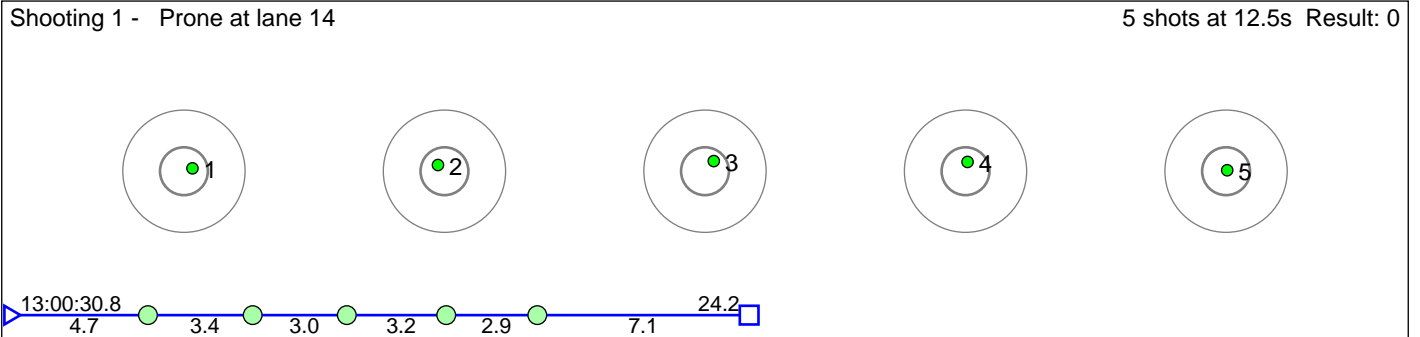

Disclaimer:

These results are unofficial since only the final output from the timing system can provide complete and correct competition results. The graphic plot of each series, presents the location of the shots on each of the five targets. Please observe that the accuracy of the plotting has some limitations due to image resolution and/or printer quality.

108 Gjelland Kristi Skjelbreid

HÅÅlandsdal IL

Result: 6

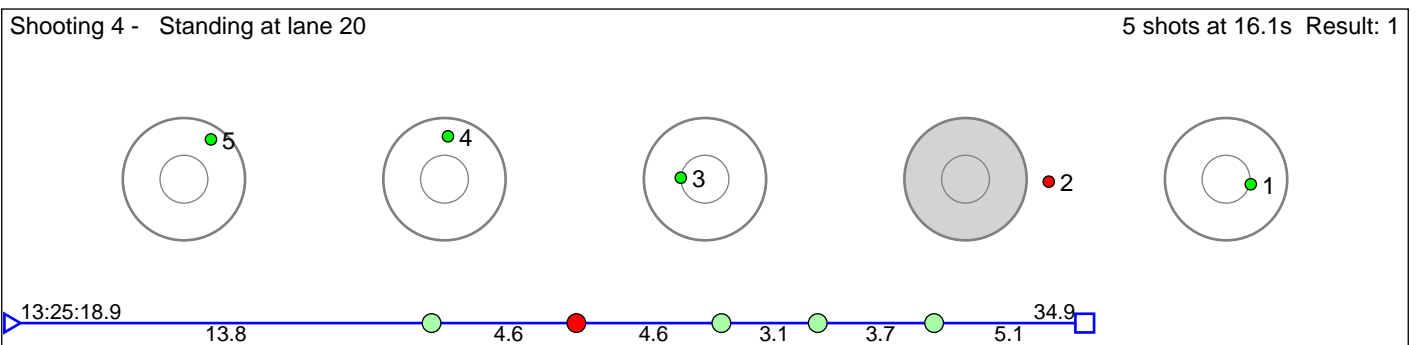
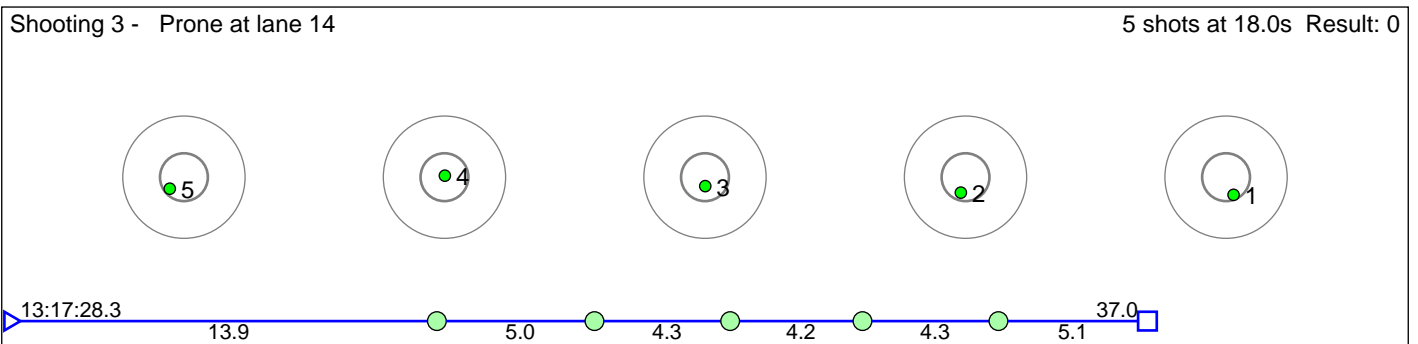
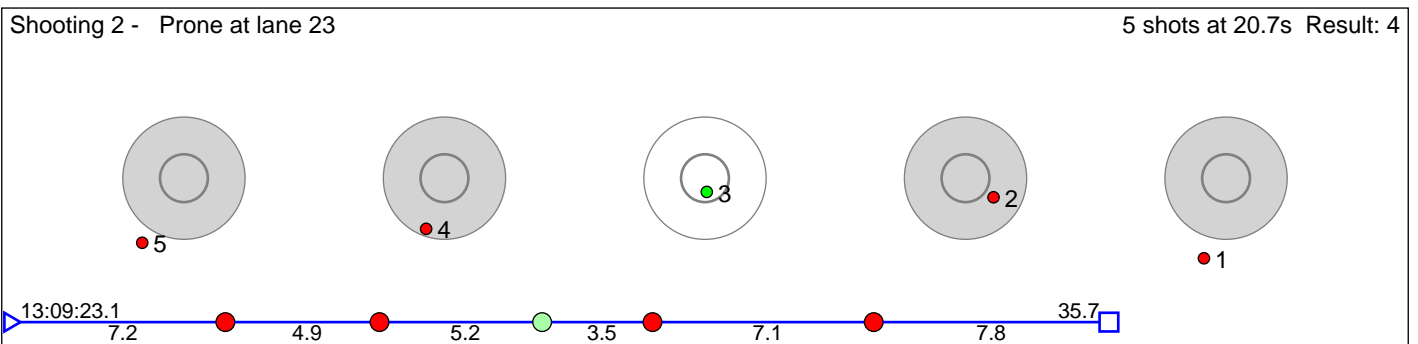
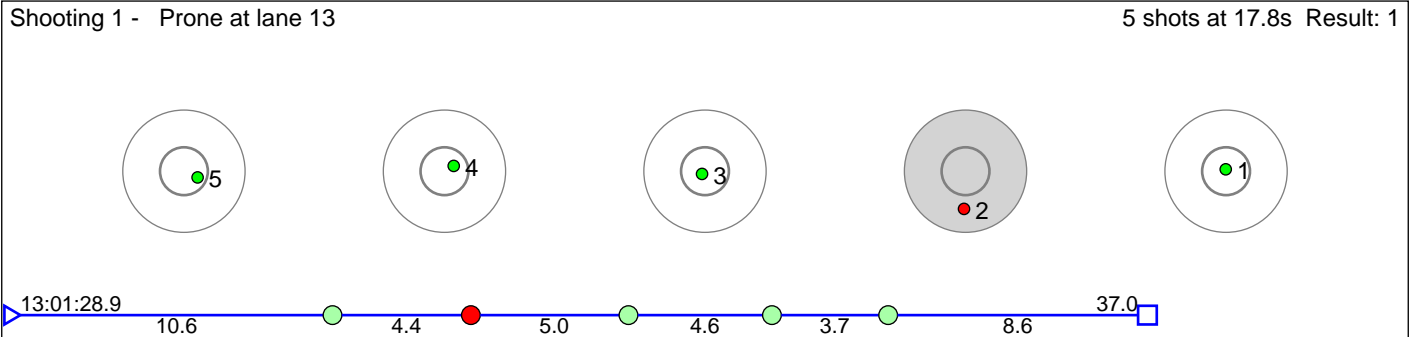

Disclaimer:

These results are unofficial since only the final output from the timing system can provide complete and correct competition results. The graphic plot of each series, presents the location of the shots on each of the five targets. Please observe that the accuracy of the plotting has some limitations due to image resolution and/or printer quality.

109 Totland Tiril Ure

Eldar IL

Result: 6

Shooting 1 - Prone at lane 2 5 shots at 18.8s Result: 1

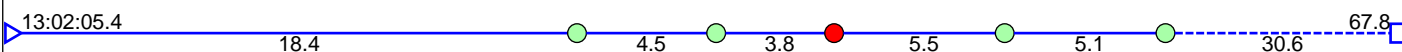
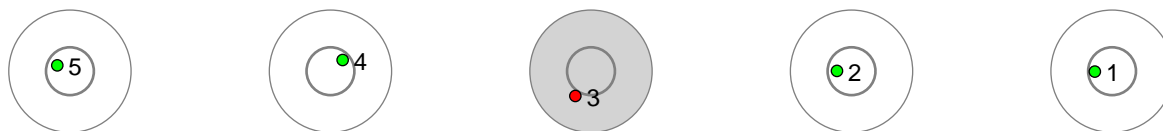

Shooting 2 - Standing at lane 21 5 shots at 11.8s Result: 2

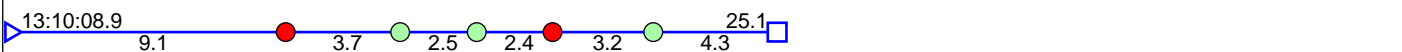
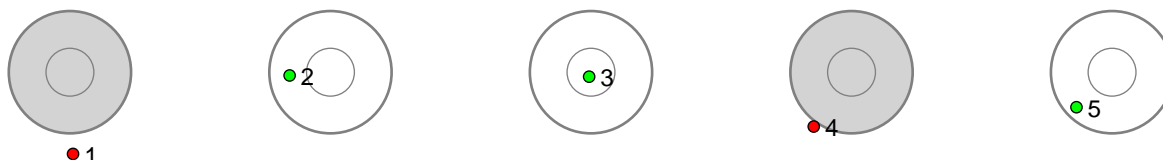

Shooting 3 - Prone at lane 2 5 shots at 18.3s Result: 1

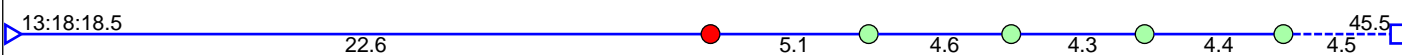
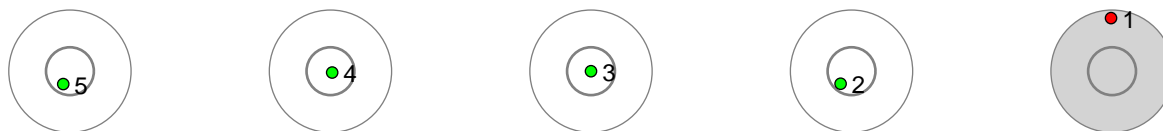

Shooting 4 - Standing at lane 17 5 shots at 11.5s Result: 2

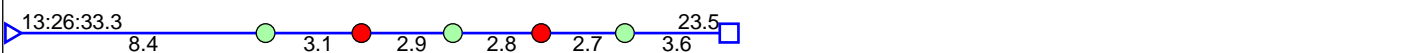
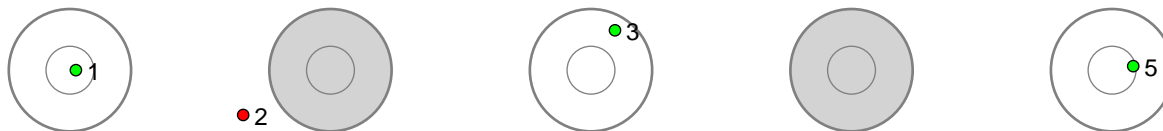

Disclaimer:

These results are unofficial since only the final output from the timing system can provide complete and correct competition results. The graphic plot of each series, presents the location of the shots on each of the five targets. Please observe that the accuracy of the plotting has some limitations due to image resolution and/or printer quality.

110 Due Matias

Voss Skiskytterlag

Result: 17

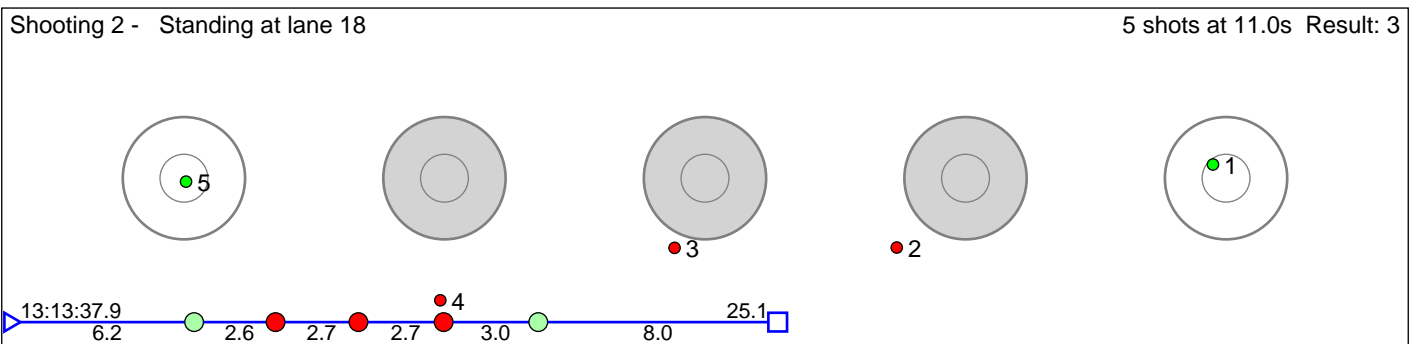
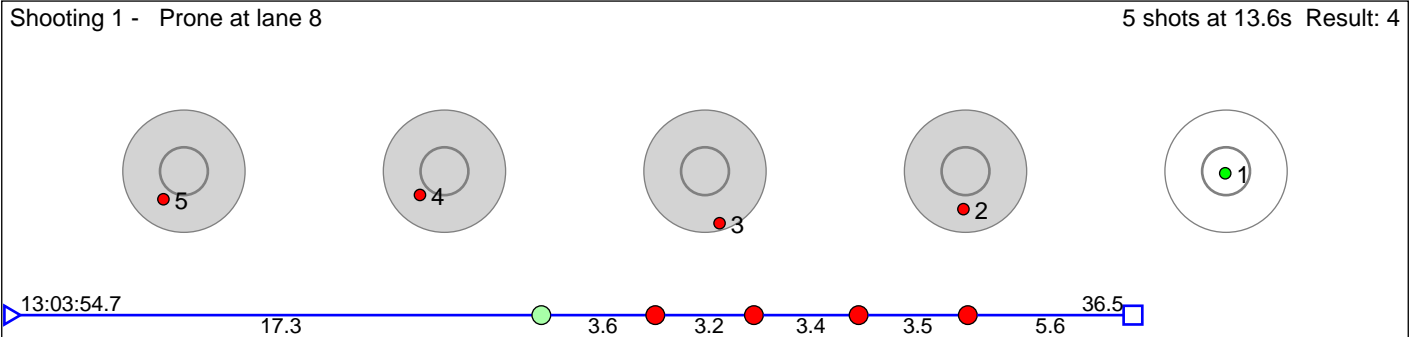

Disclaimer:

These results are unofficial since only the final output from the timing system can provide complete and correct competition results. The graphic plot of each series, presents the location of the shots on each of the five targets. Please observe that the accuracy of the plotting has some limitations due to image resolution and/or printer quality.

111 Aarseth Thomas

HÅÿlandsdal IL

Result: 1

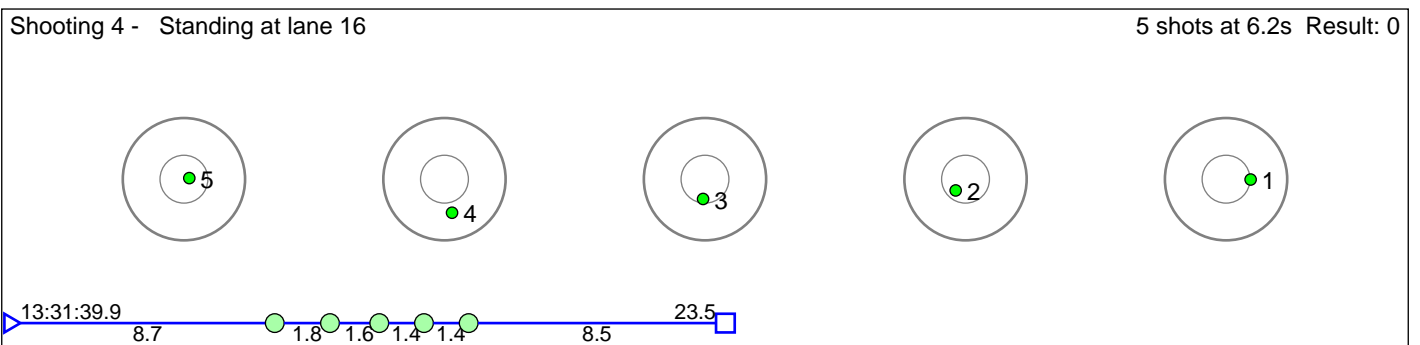
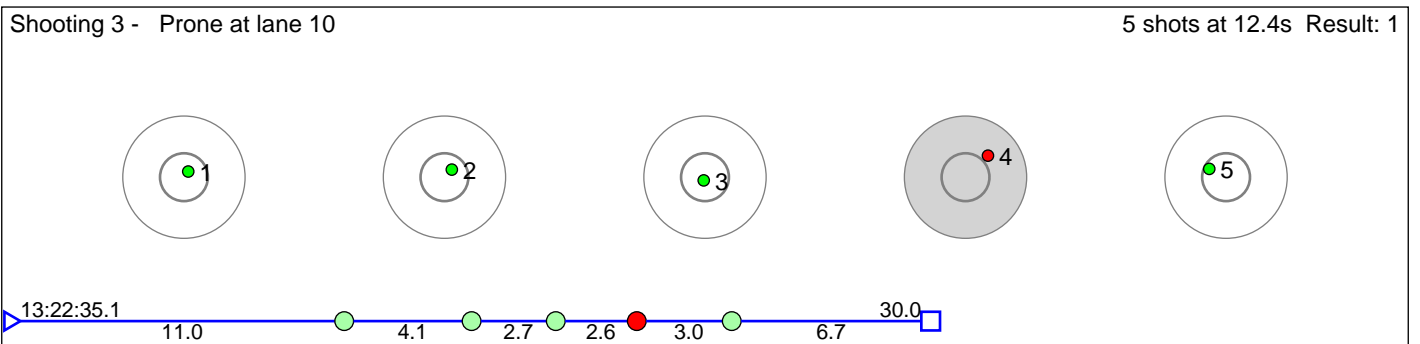
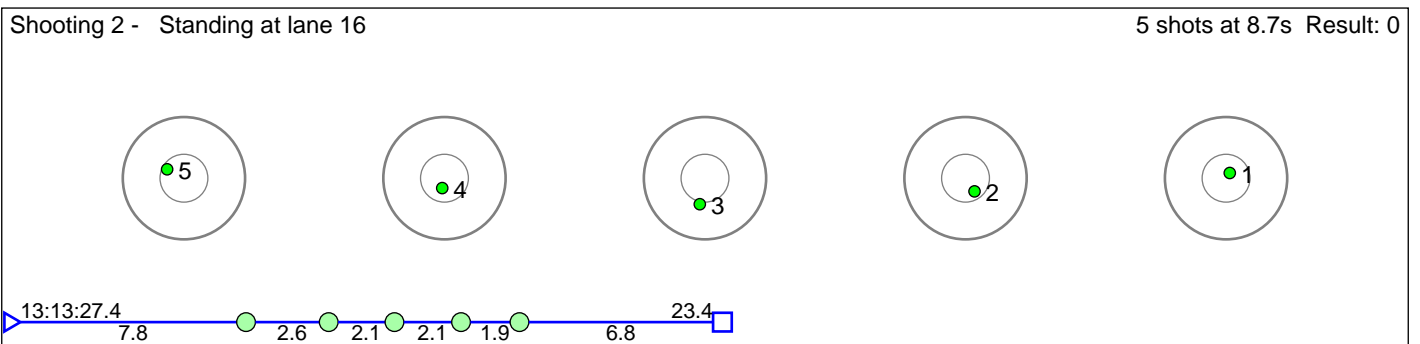
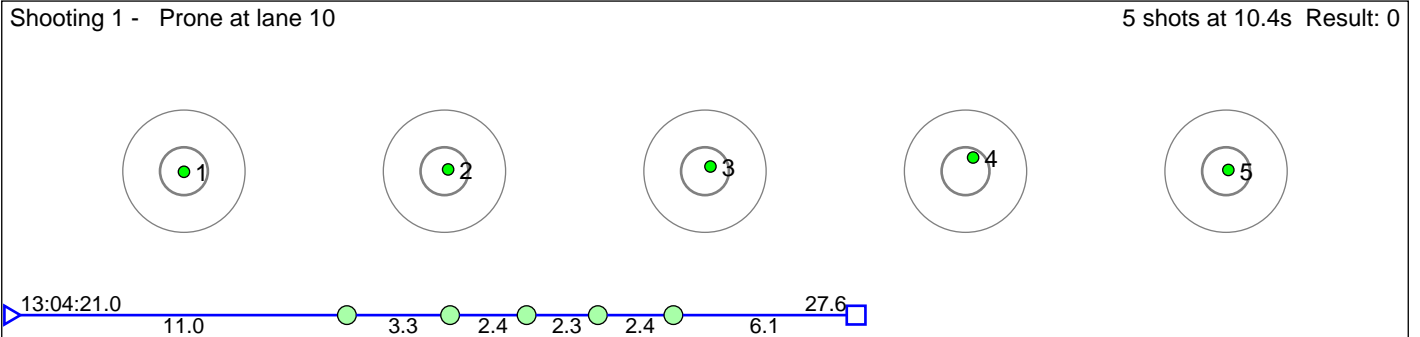

Disclaimer:

These results are unofficial since only the final output from the timing system can provide complete and correct competition results. The graphic plot of each series, presents the location of the shots on each of the five targets. Please observe that the accuracy of the plotting has some limitations due to image resolution and/or printer quality.

525

Result: 19

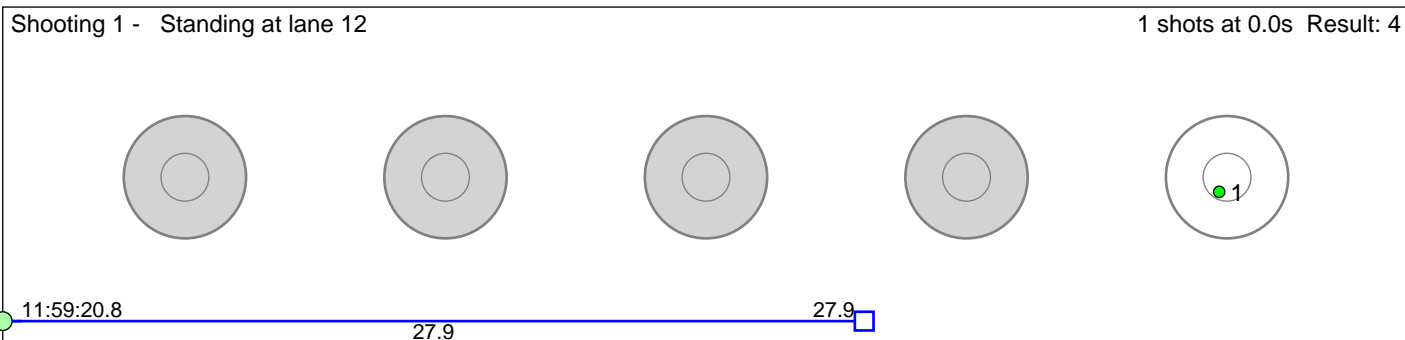

Disclaimer:

These results are unofficial since only the final output from the timing system can provide complete and correct competition results. The graphic plot of each series, presents the location of the shots on each of the five targets. Please observe that the accuracy of the plotting has some limitations due to image resolution and/or printer quality.